

EFP1000II-EFP1500II-EFP2000II



EFP1000II

FORTALEZAS / STRENGTHS / FORCES

- ✓ Mejora de la clasificación energética, debido al uso del refrigerante R-290, ventiladores electrónicos y de la circulación optimizada del aire para una mejor uniformidad de temperatura en el interior.
Mayor precisión en el control de la temperatura.
Puertas correderas con tirador integrado.
- ✓ Improved energy classification due to the use of R-290 refrigerant, electronic fans and optimized air circulation for better interior temperature uniformity.
Greater precision in temperature control.
Sliding doors with integrated handle.
- ✓ Classification énergétique améliorée grâce à l'utilisation du réfrigérant R-290, des ventilateurs électroniques et à une circulation d'air optimisée pour une meilleure uniformité de la température à l'intérieur.
Plus grande précision dans le contrôle de la température.
Portes coulissantes avec poignée intégrée.

EFP1000II-EFP1500II-EFP2000II

EFP1000II-EFP1500II-EFP2000II			
Rango Tª / Operating temp / Régime de Température	+3°C / +6°C		
Clase climática / Climate class / Classe climatique	4 (30°C, 55%HR)		
Capacidad / Capacity / Capacité (l)	200-305-415		
Medidas exteriores LxFxA / Overall dimensions LxDxH / Dimensions extérieures LxIxH (mm)	1.004 x 550 x 880 1.479 x 550 x 880 1.954 x 550 x 880		
Características constructivas / Cabinet Construction / Caractéristiques du fabricant			
Material exterior / Exterior Material / Matériau extérieur	Acero inoxidable AISI 304	AISI 304 Stainless Steel	Acier Inoxydable AISI 304
Material respaldo / Back Material / Matériau à l'arrière	Acero galvanizado	Galvanized steel	Acier galvanisée
Material interior / Interior Material / Matériau intérieur	Acero inoxidable AISI 304	AISI 304 Stainless Steel	Acier Inoxydable AISI 304
Características del interior / Interior Construction / Caractéristiques intérieures	Uniones de amplio radio.	Rounded interior corner	Intérieur bords arrondis à large rayon
Desagüe / Drain / Vidange	✓		
Iluminación LED / LED lighting Eclairage LED	-		
Tipo aislamiento / Insulation / Type d'isolation	Poliuretano con densidad 40kg/m3, libre CFCs, cero ODP y bajo GWP	Polyurethane with high density 40kg/m3, CFCs free, zero ODP and low GWP	Isolation en polyuréthane injecté à haute pression de CFC avec une densité de 40kg/m³, Zéro ODP et GWP faible.
Espumante / Blowing Agent / Mousse	HFO		
Dotación / Features / Equipement de série			
Nº puertas / Doors / Nombre de portes	2-3-4		
Tipo de puerta / Door construction / Type de porte	-	-	-
Cerradura / Door lock / Serrure	✗		
Marcos puerta calefactados / Door frame heaters / Cordon chauffant encadrement porte	-		
Nº total estantes / Shelving / Nombre d'étagères	-		
Dimensiones estantes LxF / Shelves dimensions LxD / Dimensions des étagères L x l(mm)	-		
Tipo de patas, ruedas / Legs, casters / Type de pieds, roulettes	-	-	-
Características frigoríficas / Refrigeration / Caractéristiques du froid			
Controlador / Thermostat / Thermostat	-	-	-
Desescarche / Defrost / Dégivrage	-	-	-
Dispositivo expansión / Expansion Device / Détendeur	Capilar	Capillary	Capillaire
Ventiladores electrónicos / Electronic fans / Ventilateurs électroniques	✗		

Sistema de condensación / Condensation / Système de condensation	Forzada	Forced-air	Forcé
Sistema de evaporación / Evaporation / Système d'évaporation	Evaporador tratado con epoxi de poliéster anticorrosión	Evaporator with anti corrosion epoxy coating	Evaporateurs traités avec polyester anticorrosion,
Datos técnicos / Technical Features / Informations techniques			
Refrigerante / Refrigerant / Gaz réfrigérant	R600a-R290-R290		
Carga / Ref amount / Charge de gaz (gr)	75-100-120		
Tensión/fases/frecuencia / Power Supply / Tension /phase/Fréquence	230V / 1 / 50 Hz		
Potencia frigorífica / Refrigeration Capacity / Puissance frigorifique (W)	169-370-370		
Potencia / Power / Puissance (W)	122-200-200		
Intensidad / Amps / Intensité (A)	0,6-1,2-1,2		
Consumo / Energy Consumption / Consommation (kWh/24h)	-		
Clasificación Energética / Energy Class / Classification énergétique	-		
Paletización / Crating / Palettisation			
Medidas paletización LxFxA / Crated dimensions / Dimensions palettisation L x l x H (mm)	1.030 x 580 x 900		
	1.570 x 580 x 1.040		
	2.000 x 580 x 1.040		
Volumen bruto / Crated volume / Volume brut (l)	486-716-946		
Peso neto / Net Weight / Poids net (kg)	46-71-89		
Peso paletización / Crated Weight / Poids palettisation (kg)	54-84-105		
Opcionales / Options			
	Separador	Divider	Séparateur
	115V/1ph/60Hz	115V/1ph/60Hz	115V/1ph/60Hz
	230V/1ph/60Hz	230V/1ph/60Hz	230V/1ph/60Hz

www.infrico.com

info@infrico.com

Ctra. de Aguilar A-318 por Moriles Km. 15,5 – A-3132 - 14900, Lucena (Córdoba)

Características técnicas y constructivas sujetas a variación sin previo aviso

We reserve the right to change specifications without prior notice

Les caractéristiques techniques et la conception peuvent être sujettes à modifications, sans préavis



EFP1000II-EFP1500II-EFP2000II

ALZADO/ ELEVATION/ VUE LATÉRAL

PLANTA/PLAN VIEW/DESSUS/VUE DE PROFIL

PERFIL/RIGHT VIEW/VUE EN PLAN

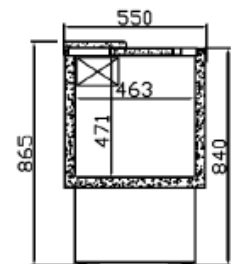
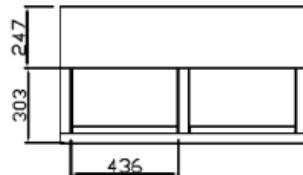
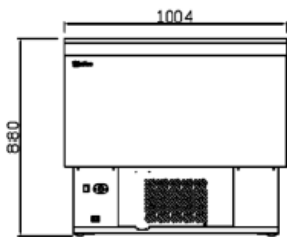

EFP1000II

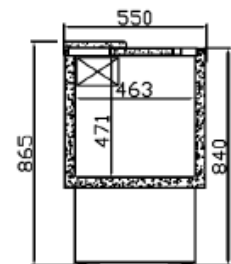
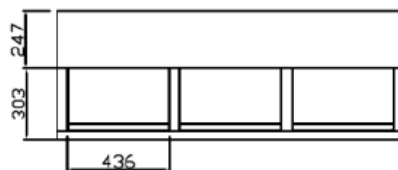
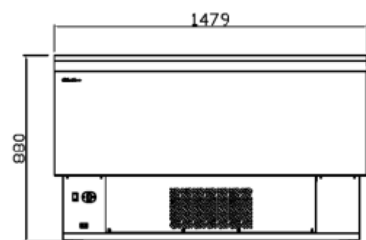

EFP1500II

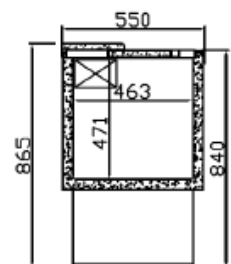
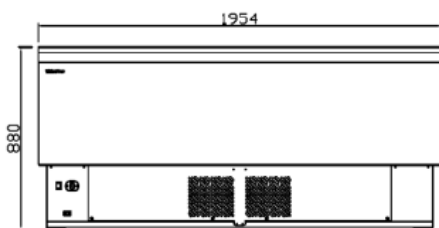

EFP2000II

www.infrico.com

info@infrico.com

Ctra. de Aguilar A-318 por Moriles Km. 15,5 – A-3132 - 14900, Lucena (Córdoba)

Características técnicas y constructivas sujetas a variación sin previo aviso

We reserve the right to change specifications without prior notice

Les caractéristiques techniques et la conception peuvent être sujettes à modifications, sans préavis



EFP1000II-EFP1500II-EFP2000II

CONEXIONES / CONNECTION / CONNEXIONS

MODELOS	A (mm)	B (mm)	C (mm)	D (mm)	E (mm)	F (mm)	G (mm)
EFP1000II / EG	254	94	70	160	233	60	38
EFP1500II / EG	254	94	70	160	233	60	38
EFP2000II / EG	254	94	70	160	233	60	40

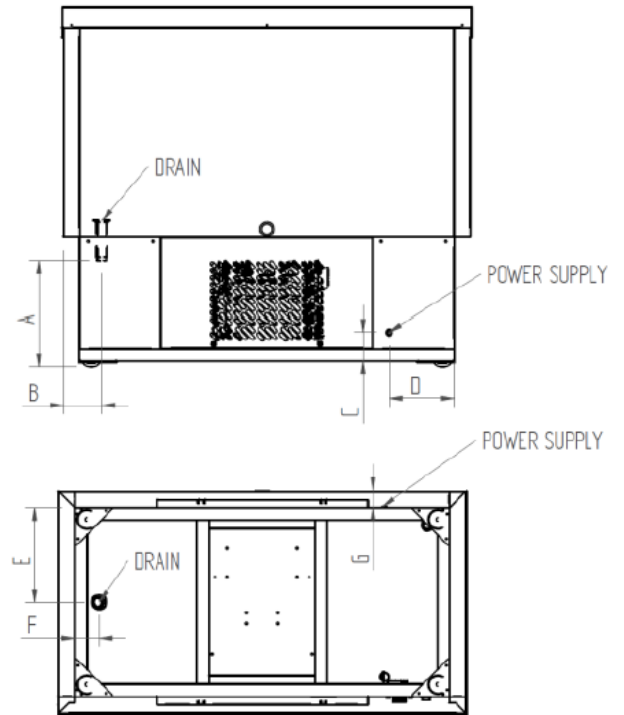

Rev: 01 Fecha/Date: 16/09/2019 FT_EFP1000II_00_ES.EN.FR_19_01 FT_EFP1500II_00_ES.EN.FR_19_01 FT_EFP2000II_00_ES.EN.FR_19_01

www.infrico.com

info@infrico.com

Ctra. de Aguilar A-318 por Moriles Km. 15,5 – A-3132 - 14900, Lucena (Córdoba)

Características técnicas y constructivas sujetas a variación sin previo aviso

We reserve the right to change specifications without prior notice

Les caractéristiques techniques et la conception peuvent être sujettes à modifications, sans préavis

