

# MSG2000-MSG2400



## BENEFICIOS / BENEFITS / AVANTAGES

- ✓ Mejora de la clasificación energética, debido al uso del refrigerante R-290, ventiladores electrónicos y de la circulación optimizada del aire para una mejor uniformidad de temperatura en el interior.  
Mayor precisión en el control de la temperatura.  
Nuevo diseño de puertas con tirador de doble agarre.
- ✓ Improved energy classification due to the use of R-290 refrigerant, electronic fans and optimized air circulation for better interior temperature uniformity.  
Greater precision in temperature control.  
New door design with double grip handle.
- ✓ Classification énergétique améliorée grâce à l'utilisation du réfrigérant R-290, des ventilateurs électroniques et à une circulation d'air optimisée pour une meilleure uniformité de la température à l'intérieur.  
Plus grande précision dans le contrôle de la température.  
Nouveau design de porte avec poignée à double poignée.

MSG2000

# MSG2000-MSG2400

## MSG2000-MSG2400

Rango Tª / Operating temp / Régime de Température	-2°C / +8°C		
Clase climática / Climate class / Classe climatique	5 (40°C, 40%HR)		
Capacidad / Capacity / Capacité (l)	310-435		
Medidas exteriores LxFxA / Overall dimensions LxDxH / Dimensions extérieures LxIxH (mm)	2.000 x 700 x 650 2.400 x 700 x 650		
<b>Características constructivas / Cabinet Construction / Caractéristiques du fabricant</b>			
Material exterior / Exterior Material / Matériau extérieur	Acero inoxidable AISI 304	AISI 304 Stainless Steel	Acier Inoxydable AISI 304
Material respaldo / Back Material / Matériau à l'arrière	Acero inoxidable AISI 304	AISI 304 Stainless Steel	Acier Inoxydable AISI 304
Material interior / Interior Material / Matériau intérieur	Acero inoxidable AISI 304	AISI 304 Stainless Steel	Acier Inoxydable AISI 304
Características del interior / Interior Construction / Caractéristiques intérieures	Uniones de amplio radio.	Rounded interior corner	Intérieur bords arrondis à large rayon
Desagüe / Drain / Vidange	✓		
Iluminación LED / LED lighting Eclairage LED	-		
Tipo aislamiento / Insulation / Type d'isolation	Poliuretano con densidad 40kg/m3, libre CFCs, cero ODP y bajo GWP	Polyurethane with high density 40kg/m3, CFCs free, zero ODP and low GWP	Isolation en polyuréthane injecté à haute pression de CFC avec une densité de 40kg/m <sup>3</sup> , Zéro ODP et GWP faible.
Espesor aislamiento / Insulation thickness / Epaisseur de l'isolation (mm)	70		
Espumante / Blowing Agent / Mousse	HFO		
<b>Dotación / Features / Equipement de série</b>			
Nº puertas / Doors / Nombre de portes	3-4		
Tipo de puerta / Door construction / Type de porte	Puerta ciega, con tirador integrado de doble agarre y bisagra pivotante con bloqueo de apertura. Contrapuerta embutida con burlete plano "cleanless" de cuatro cámaras, fácilmente sustituible.	Solid door with integrated double-trip handle and pivoting hinge and stay open door mechanism. Pressed rear door with four chamber cleanless door gasket, easily replaceable.	Porte pleine, avec tiroir à double poignée intégrée et bisagra pivotant avec blocage d'ouverture. Contreporte emboutie à bourrelet plan "cleanless" facilement remplaçable.
Cerradura / Door lock / Serrure	✗		
Marcos puerta calefactados / Door frame heaters / Cordon chauffant encadrement porte	✗		
Nº total estantes / Shelving / Nombre d'étagères	3-4		
Dimensiones estantes LxH / Shelves dimensions LxD / Dimensions des étagères L x l(mm)	GN 1/1 (530x325)		
Tipo de patas, ruedas / Legs, casters / Type de pieds, roulettes	Patas en acero inoxidable, regulables en altura 130-180mm	Stainless steel legs, height adjustable from 130-180mm	Pieds en acier inoxydable, hauteur réglable 130-180mm

Características frigoríficas / Refrigeration / Caractéristiques du froid			
Controlador / Thermostat / Thermostat	Táctil, IP65	Touch-screen, IP65	Tactile, IP65
Sistema de frío / Refrigeration system / Système de froid	Monoblock		
Desescarche / Defrost / Dégivrage	Parada de compresor	Compressor off	Arrêt du compresseur
Dispositivo expansión / Expansion Device / Détendeur	Capilar	Capillary	Capillaire
Ventiladores electrónicos / Electronic fans / Ventilateurs électroniques	✓		
Sistema de condensación / Condensation / Système de condensation	Forzada	Forced-air	Forcé
Sistema de evaporación / Evaporation / Système d'évaporation	Evaporación con aire forzado, evaporador tratado con epoxi de poliéster anticorrosión	Forced-air evaporator with anti corrosion epoxy coating	Système d'évaporation ventilé, évaporateurs traités avec polyester anticorrosion,
Bandeja evaporativa / Condensate pan / Bac d'évaporation	Bandeja con serpentín embutido	Pan with pressed serpentin	Bac avec serpentine emboutis
Datos técnicos / Technical Features / Informations techniques			
Refrigerante / Refrigerant / Gaz réfrigérant	R290		
Carga / Ref amount / Charge de gaz (gr)	100-110		
Tensión/fases/frecuencia / Power Supply / Tension /phase/Fréquence	230V / 1 / 50 Hz		
Potencia frigorífica / Refrigeration Capacity / Puissance frigorifique (W)	370-687		
Potencia / Power / Puissance (W)	209-368		
Intensidad / Amps / Intensité (A)	1,2-2,5		
Consumo / Energy Consumption / Consommation (kWh/24h)	1,61-1,77		
Clasificación Energética / Energy Class / Classification énergétique	B		
Paletización / Crating / Palettisation			
Medidas paletización LxFxA / Crated dimensions / Dimensions palettisation L x l x H (mm)	2.070 x 660 x 990 2.520 x 660 x 990		
Volumen bruto / Crated volume / Volume brut (l)	910-1092		
Peso neto / Net Weight / Poids net (kg)	170-207		
Peso paletización / Crated Weight / Poids palettisation (kg)	200-244		
Opcionales / Options			
Cerradura	Lock door	Serrure	
Puerta	Door	Porte	
Cajón 2/3x300	Drawer 2/3x300	Tiroir 2/3x300	

[www.infrico.com](http://www.infrico.com)

[info@infrico.com](mailto:info@infrico.com)

Ctra. de Aguilar A-318 por Moriles Km. 15,5 – A-3132 - 14900, Lucena (Córdoba)

Características técnicas y constructivas sujetas a variación sin previo aviso

We reserve the right to change specifications without prior notice

Les caractéristiques techniques et la conception peuvent être sujettes à modifications, sans préavis



# MSG2000-MSG2400

ALZADO/ ELEVATION/ VUE LATÉRAL

PLANTA/PLAN VIEW/DESSUS/VUE DE PROFIL

PERFIL / RIGHT VIEW / VUE EN PLAN

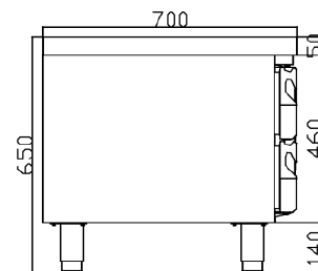
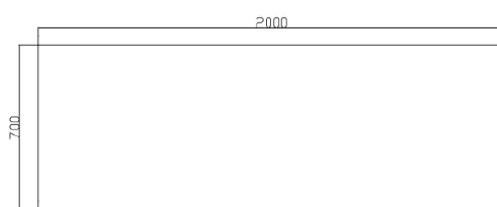
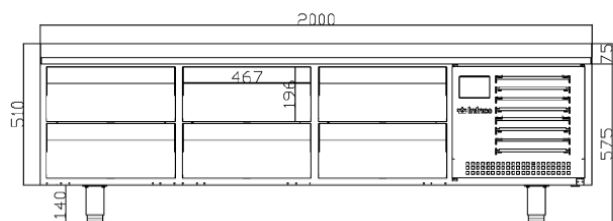

MSG2000

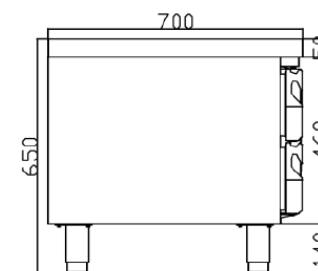
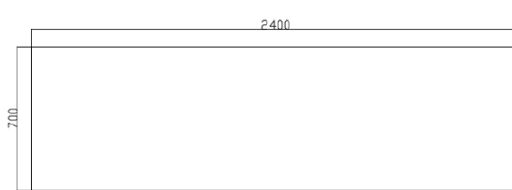
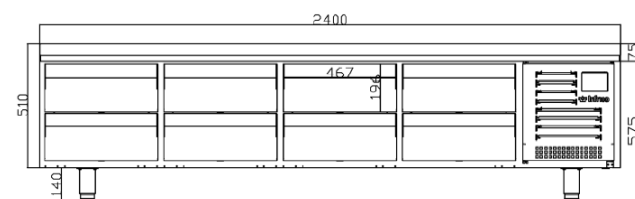

MSG2400

## CONEXIONES /CONNECTION / CONNEXIONS

MODELOS	A (mm)	B (mm)	C (mm)	D (mm)
MSG2000	60	61	800	112
MSG2400	60	61	992	112

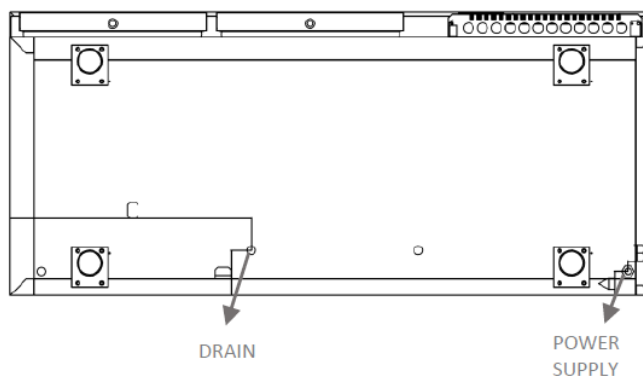

[www.infrico.com](http://www.infrico.com)  
[info@infrico.com](mailto:info@infrico.com)

Ctra. de Aguilar A-318 por Moriles Km. 15,5 – A-3132 - 14900, Lucena (Córdoba)

Características técnicas y constructivas sujetas a variación sin previo aviso  
 We reserve the right to change specifications without prior notice

Les caractéristiques techniques et la conception peuvent être sujettes à modifications, sans préavis

