

HIDRO-80

Insertable de Leña Hidro



EQUIPAMIENTO

- Sistema de Doble Combustión y Cristal Limpio.
- Medidas Entrada Leña (AxHxF): 625 x 340 x 350 mm.
- Salida Humos Macho Ø 200 mm.
- Cristal Vitrocerámico 750 °C.
- Interior Cámara en Vermiculita.
- Puerta y Rejilla de fundición.
- Válvula Cortatiros.

CARACTERÍSTICAS TÉCNICAS

Potencia Térmica Máxima 23,6 kW.

Potencia Nominal 19,0 kW.

Potencia Cedida al Agua 12 kW.

Temperatura de Humos Media 165 °C.

Rendimiento 80,40%.

Combustible Leña.

Volumen Calefactable 523 m³.

Consumo 5,25 kg/h.

CO al 13% O₂ 0,09 %.

Partículas al 13% O₂ 29,00 mg/Nm³.

Equipo elaborado en Acero Hasta 5 mm.

Regulación Entrada de Aire Primario

Pintura Anticalórica 800°C. Color Negro.

Tamaño de Tronco 68 cm.

Peso 152 kg.

Medidas (Ancho x Fondo x Alto) 810 x 540 x 905 mm.

Medidas Frontal (Alto x Ancho) 600 x 840 mm.

Capacidad del Depósito Hidro 65 Litros.

ACCESORIOS

- Bote de Spray Pintura Anticalórica 800°C. Color Negro.
- Manguito Anticondensaciones. Negro Vitrificado.
- Bastidor con Patas Regulables en Altura.
- 2 Boquillas Ø 80 mm para Canalización Aire Primario.
- Válvula de Sobrepresión 3 bar.
- Válvula Termostática de Seguridad.
- Válvula Anticondensados 1 1/2".
- Regulador de Tiro.

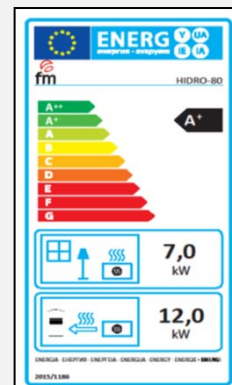

HIDRO-80

Versiones



HIDRO-80



HIDRO-80. Interior Vermiculita.

Ficha Técnica

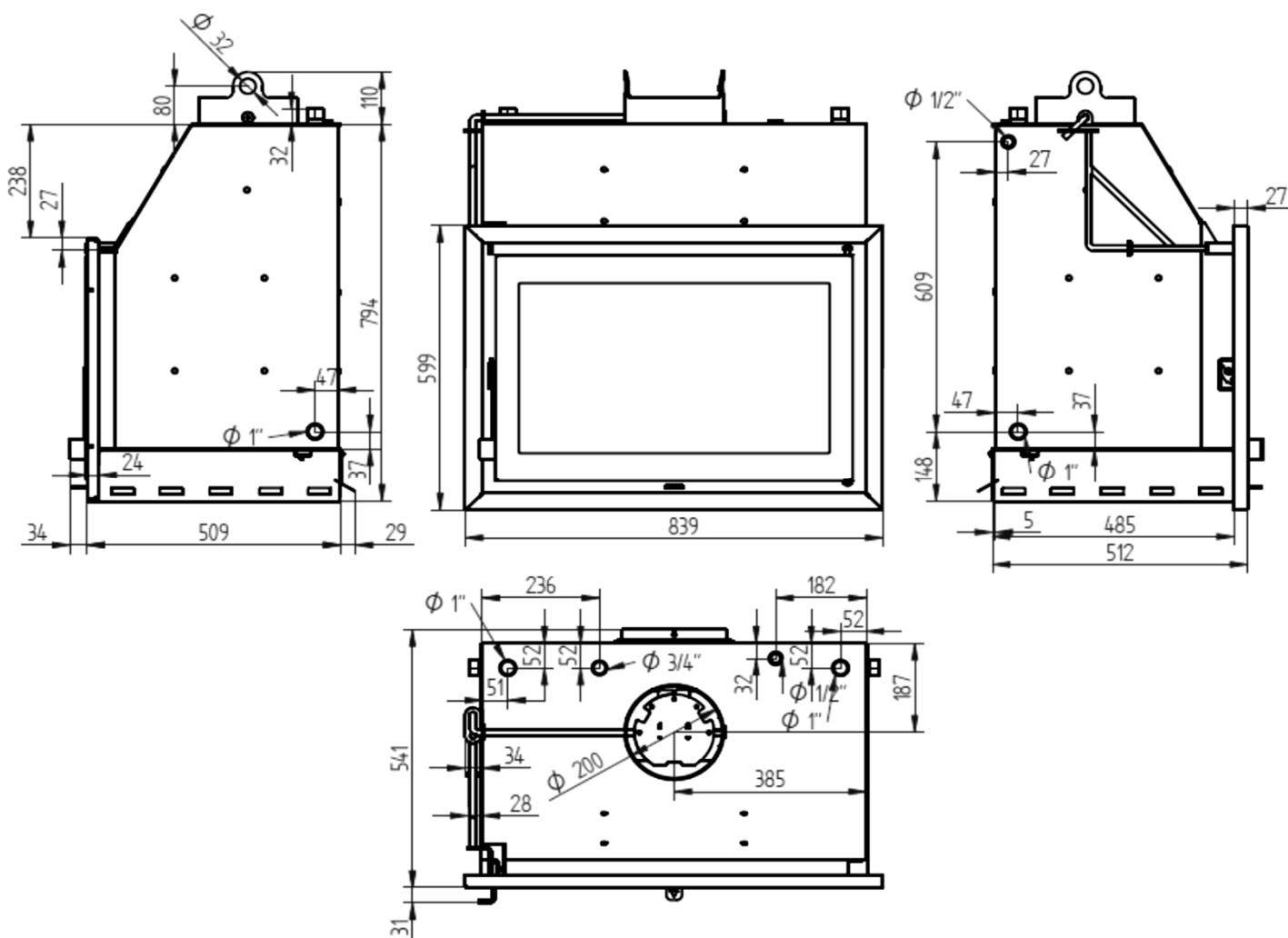

HIDRO-80

Wood Burning Hydro Insert



EQUIPMENT

- Double Combustion and Clean Glass System.
- Firewood Measures (WxDxH): 625 x 340 x 350 mm.
- Output Male Fumes Ø 200 mm.
- Glass-ceramic glass 750 °C.
- Interior Camera in Vermiculite.
- Cast iron door and grid.
- Throwshot Shorter Valve.

SPECIFICATIONS

Maximum thermal input 23,6 kW.

Rated Power 19,0 kW.

Power Ceded to Water 12 kW.

Medium Smoke Temperature 165 °C.

Yield 80,40%.

Fuel Wood.

Heated Volume 523 m3.

Consumption 5,25 kg/h.

CO al 13% O2 0,09 %.

Particulate matter at 13% O2 29,00 mg/Nm3.

Equipment made of Steel Unifl 5 mm.

Primary Air Intake Regulation

Anticaloric Paint 800°C. Black Color.

Trunk Size 68 cm.

Weight 152 kg.

Measurements (WxDxH) 810 x 540 x 905 mm.

Front Measurements (HxW) 600 x 840 mm.

Hydro Tank Capacity 65 Liters.

ACCESSORIES

- Spray Bottle Anticaloric Paint 800°C. Black Color.
- Anti-condensation cuff. Black Vitrified.
- Frame with Height Adjustable Legs.
- 2 Nozzles Ø 80 mm for Primary Air Channeling.
- Overpressure valve 3 bar.
- Thermostatic Safety Valve.
- Anti-condensate valve 1 1/2".
- Draft Regulator.

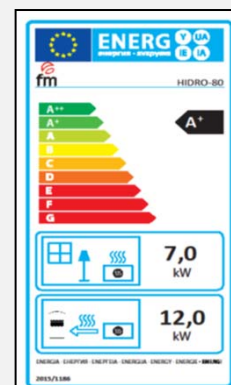

HIDRO-80

Versions



HIDRO-80



HIDRO-80. Vermiculite Interior.

Data Sheet

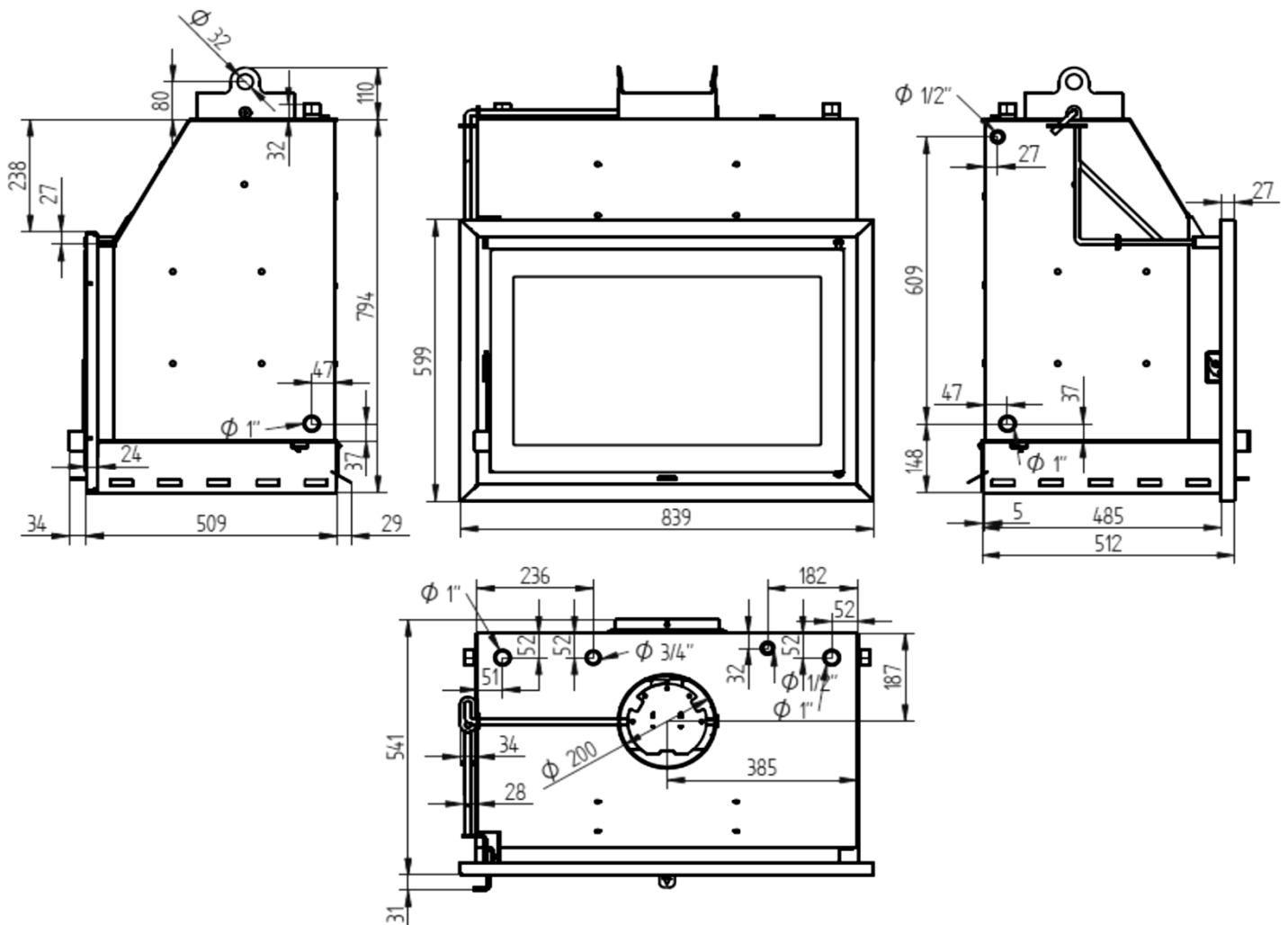

HIDRO-80

Insérable à Bois Hydro



ÉQUIPEMENT

- Double combustion et système de verre propre.
- Mesures d'intrants bois (AxHxF): 625 x 340 x 350 mm.
- Sortie de fumées mâle Ø 200 mm.
- Verre vitrocéramique 750 °C.
- Caméra intérieure en vermiculite.
- Porte et grille en fonte.
- Valve Throwshot plus courte.

SPÉCIFICATIONS

Puissance thermique maximale 23,6 kW.

Puissance nominale 19,0 kW.

Puissance cédée à l'eau 12 kW.

Température moyenne de fumée 165 °C.

Rendement 80,40%.

Combustible Bois à brûler.

Volume chauffé 523 m³.

Consommation 5,25 kg/h.

CO al 13% O2 0,09 %.

Matières particulaires 13 % O2 29,00 mg/Nm³.

Équipement en acier Jusqu'à 5 mm.

Règlement sur l'admission d'air primaire

Peinture anticorrosive 800°C. Couleur Noir.

Taille du tronc 68 cm.

Poids 152 kg.

Mesures (L x P x H) 810 x 540 x 905 mm.

Mesures avant (H x L) 600 x 840 mm.

Capacité du Réservoir D'eau 65 Litres.

ACCESSOIRES

- Peinture chaude en aérosol 800°C. Couleur Noir.
- Brassard anti-condensation. Noir vitrifié.
- Cadre avec pieds réglables en hauteur.
- 2 buses Ø 80 mm pour la canalisation d'air primaire.
- Soupape de surpression 3 bar.
- Soupape de sécurité thermostatique.
- Vanne anti-condensat 1 1/2 ».
- Projet de régulateur.

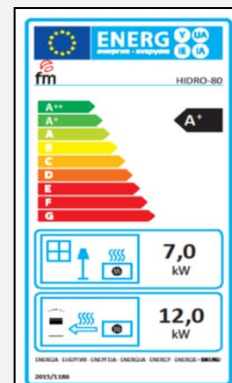

HIDRO-80

Versions



HIDRO-80



HIDRO-80. Vermiculite intérieure.

Fiche technique

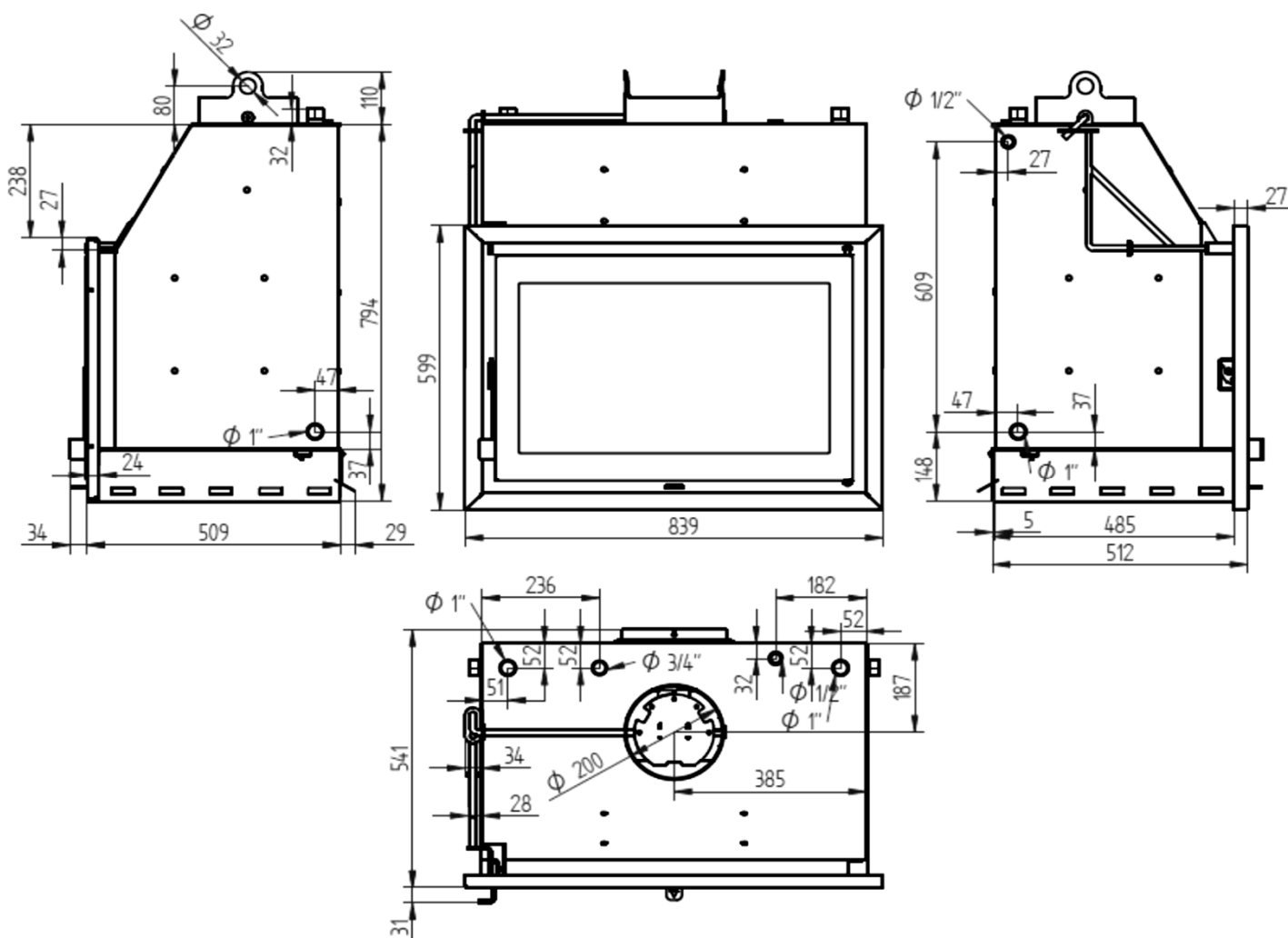

HIDRO-80

Lenha Inserível Hydro



EQUIPAMENTOS

- Combustão dupla e sistema de vidro limpo.
- Medidas entrada lenha (LxPxA): 625 x 340 x 350 mm.
- Saída fumos machos Ø 200 mm.
- Vidro vitrocerâmico a 750 °C.
- Câmara interior em vermiculita.
- Porta e grade de fundição.
- Throwshot Válvula mais curta.

ESPECIFICAÇÕES

Potência Térmica Máxima 23,6 kW.

Potência Nominal 19,0 kW.

Energia Cedida à Água 12 kW.

Temperatura Média de Fumo 165 °C.

Rendimento 80,40%.

Combustível Leña.

Volume Aquecido 523 m3.

Consumo 5,25 kg/h.

CO 13% O2 0,09 %.

Partículas em Suspensão 13% O2 29,00 mg/Nm3.

Equipamento em Aço Até 5 mm.

Regulação da Admissão de Ar Primário

Tinta Anticalórica 800°C. Cor Preto.

Tamanho do Tronco 68 cm.

Peso 152 kg.

Medições (LxPxA) 810 x 540 x 905 mm.

Medições Frontais (AxL) 600 x 840 mm.

Capacidade do Tanque de Água 65 Litros.

ACESSÓRIOS

- Frasco de Spray Tinta Anticalórica 800°C. Cor Preto.
- Punho anti-condensação. Preto Vitrificado.
- Quadro com pernas ajustáveis em altura.
- 2 bicos Ø 80 mm para canalização de ar primária.
- Válvula de sobrepresão 3 bar.
- Válvula de segurança termostática.
- Válvula anti-condensado 1 1/2".
- Projeto de Regulador.

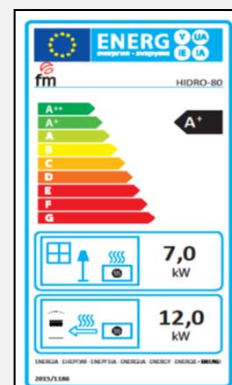

HIDRO-80

Versões



HIDRO-80



HIDRO-80. Interior Vermiculita.

Folha

