



UDEX

SOLUTIONS FOR LIFE



# HOTELARIA

## REV. 1/2/2024



HÔTELLERIE  
HOSTELERÍA  
HOTEL INDUSTRY





# UDEX S.A.



## TUDO PARA HOTELARIA NUM SÓ LUGAR

A UDEX é uma empresa de referência no sector da Hotelaria Industrial, estando implantada em Portugal, desde a década de 70, tendo conquistado, desde então, a confiança dos seus clientes. Com uma presença consolidada no mercado Português, está presente em países como a França, Suíça e Espanha. A Udex tem hoje uma vasta equipa multidisciplinar na qual se inclui a equipa técnica especializada, capaz de dar apoio na instalação e manutenção das soluções propostas, que tem sido um fator decisivo na competitividade da Udex, pela capacidade de garantir o funcionamento e longevidade das soluções fornecidas aos seus parceiros de negócios.

## EVERYTHING FOR HOSPITALITY INDUSTRY IN ONE PLACE

UDEX is a reference company in the Industrial Hospitality sector, having been established in Portugal since the 70's, having since then won the trust of its customers. With a consolidated presence in the Portuguese market, it is present in countries such as France, Switzerland and Spain. Udex now has a vast multidisciplinary team, which includes a specialized technical team, capable of supporting the installation and maintenance of the proposed solutions, which has been a decisive factor in Udex's competitiveness, due to its ability to guarantee the functionality and longevity of the solutions provided to its business partners.



# ATIVOS ESTRATÉGICOS

## STRATEGIC ASSETS



Armazéns próprios com uma área aproximada de 8.000 m2.

Own warehouses with an approximate area of 8.000 m2.



Mantém uma elevada disponibilidade de stock, o que permite responder de forma mais rápida às necessidades do seu negócio.

It maintains a high stock availability, which allows you to respond more quickly to the needs of your business.



Equipa técnica que dá apoio e formação aos clientes e parceiros da UDEX em todo o território nacional.

Technical team that provides support and training to UDEX customers and partners throughout the national territory.



Prestação de soluções ajustadas às necessidades dos seus clientes, criando relações de proximidade e confiança.

Provision of solutions tailored to the needs of its customers, creating relationships of closeness and trust.



## MISSÃO

*Fornecimento de equipamentos e soluções globais de hotelaria que satisfaçam plenamente as necessidades dos nossos clientes, parceiros e partes interessadas.*

### MISSION

*Providing hospitality equipment and global solutions that fully meet the needs of our customers, partners and stakeholders.*

## VISÃO

*Ser um farol no setor, inspirando a indústria da hotelaria, os nossos clientes e parceiros na melhoria contínua que permita um crescimento sustentado com foco nas pessoas, e no respeito pelo meio ambiente.*

### VISION

*To be a beacon in the sector, inspiring the hospitality industry, our customers and partners to a continuous improvement that allows for a sustained growth focused on people and the respect for the environment.*



# UDEX S.A.

## TUDO PARA HOTELARIA NUM SÓ LUGAR

A UDEX é detentora de várias marcas, das quais destacamos a UDi e a UDifri, dedicadas ao fornecimento de equipamentos e acessórios para as múltiplas finalidades do universo da hotelaria.

Representamos também marcas de prestígio como Dühr, Ipso, Brema, Futurmat, Kromo, Gelmatic, Sagi e Silko que complementam o portefólio das marcas próprias.



O Departamento de Acessórios dispõe de um portefólio multimarcas de milhares de referências que permite dar resposta às necessidades de manutenção e reparação de todas as tipologias de equipamentos, garantindo a máxima longevidade do seu investimento.

O pessoal especializado e o sistema de automação de armazenamento e catalogação de peças contribuem para a melhoria nos tempos de resposta às solicitações dos nossos clientes.



## EVERYTHING FOR HOSPITALITY INDUSTRY IN ONE PLACE

UDEX owns several brands, of which we highlight UDi and UDifri, dedicated to the supply of equipment and accessories for the multiple purposes of the hospitality universe.

We also represent prestigious brands such as Dühr, Ipso, Brema, Futurmat, Kromo, Gelmatic, Sagi and Silko, which complement the portfolio of our own brands.

The Accessories Department has a multi-brand portfolio of thousands of references that allows it to respond to the maintenance and repair needs of all types of equipment, guaranteeing the maximum longevity of your investment.

The specialized personnel and the automation system for the storage and cataloging of parts contribute to the improvement in response times to requests from our customers.

# AS NOSSAS MARCAS



A UDi apresenta uma completa oferta nos tradicionais segmentos de equipamentos para hotelaria.

## VALORES

Os valores da UDi asseguram o compromisso que assumimos com os nossos Clientes.

## INOVAÇÃO • EFICIÊNCIA • DESIGN

A estes Valores agregamos um rigoroso controlo de qualidade e um serviço de excelência para merecer a Sua Confiança!

**UDi** Presents a complete offer in traditional segments of hospitality equipment.

## VALUES

INNOVATION - EFFICIENCY - DESIGN

UDi's values uphold the commitment we assume with our clients.

## INNOVATION EFFICIENCY DESIGN

To these values we add a rigorous quality control and an excellent service to deserve Your Trust!



Sob os mesmos valores da nossa marca UDi, disponibilizamos a submarca UDifri, dedicada às gamas de equipamentos de frio, onde a diversidade de soluções permite dar resposta a todas as exigências.

**UDifri** Under the same values of UDi, we make available to you our sub-brand UDifri, a brand dedicated to refrigeration equipment, where the diversity of solutions allows us to address every demand.

**CONSIDERAÇÕES GERAIS**  
**CONSIDÉRATIONS GÉNÉRALES**  
**CONSIDERACIONES GENERALES**  
**GENERAL CONSIDERATIONS**

 Todos os dados técnicos, imagens, modelos, características e preços estão sujeitos a possíveis variações que vão sendo atualizadas periodicamente nas fichas técnicas do produto, notícias e Downloads disponíveis no nosso website em: [www.udex.pt](http://www.udex.pt) e APP UDEX.  
 Reservados os direitos de modificar modelos, imagens e dados técnicos.  
 Consulte as condições gerais no final deste documento ou na seguinte página: [www.udex.pt/pt/condicoes-gerais-de-venda](http://www.udex.pt/pt/condicoes-gerais-de-venda).  
 Embalagens especiais e/ou madeira sob consulta.  
 Dimensões: Largura x Profundidade x Altura. IVA não incluído.



 Toutes les données techniques, images, modèles, caractéristiques et prix sont sujets à des variations possibles qui sont périodiquement mises à jour dans les fiches techniques du produit, les nouvelles et les téléchargements disponibles sur notre site Web: [www.udex.pt](http://www.udex.pt) et APP UDEX.  
 Nous nous réservons le droit de modifier les modèles, images et données techniques.  
 Voir les conditions générales à la fin de ce document ou à la page suivante: [www.udex.pt/fr/conditions-generales-de-vente](http://www.udex.pt/fr/conditions-generales-de-vente).  
 Emballage spécial et / ou bois sur demande.  
 Dimensions: Largeur x Profondité x Hauteur. TVA non comprise.





 Todos los datos técnicos, imágenes, modelos, características y precios están sujetos a posibles variaciones que van siendo actualizadas periódicamente en las fichas técnicas, noticias y descargas, del producto disponibles en nuestro sitio web: [www.udex.pt](http://www.udex.pt) y APP UDEX.  
 Reservados los derechos de modificar modelos, imágenes y datos técnicos.  
 Consulte las condiciones generales al final de este documento o en la página siguiente: [www.udex.pt/es/condiciones-generales-de-venta](http://www.udex.pt/es/condiciones-generales-de-venta).  
 Embalaje especial y/o madera bajo consulta.  
 Dimensiones: Largura x Profundidad x Altura. IVA no incluido.



 All the technical data, images, models, characteristics and prices are subject to possible variations that are periodically updated in the product's technical sheets, news and downloads available on our website: [www.udex.pt](http://www.udex.pt) and UDEX APP.  
 All rights reserved to modify models, images or technical data.  
 See the general conditions at the end of this document or on the following page: [www.udex.pt/en/general-conditions-of-sale](http://www.udex.pt/en/general-conditions-of-sale).  
 Special packaging and / or wood on request.  
 Dimensions: Width x Depth x Height. VAT not included.  
 Dimensions: Width x Depth x Height. VAT not included.



  embalagens especiais e/ou madeira sob consulta  
 emballage spécial et/ou de bois sur demande  
 embalajes especiales y/o de madera bajo consulta  
 special packaging and/or wood on request

ÍNDICE DE SEGMENTOS  
INDEX DES SEGMENTS  
ÍNDICE DE SEGMENTOS  
SEGMENT INDEX



**LAVAGEM**  
LAVAGE  
LAVADO  
WASHING

**20**



**RESTAURAÇÃO / COZEDURA**  
RESTAURATION / CUISSON  
RESTAURACIÓN / COCCIÓN  
RESTAURANT INDUSTRY / COOKING

**59**



**PIZZARIA / PADARIA / PASTELARIA**  
PIZZERIA / BOULANGERIE / PÂTISSERIE  
PIZZERÍA / PANADERÍA / PASTELERÍA  
PIZZERIA / BAKERY / PASTRY

**312**



**FRIO**  
FROID  
FRÍO  
COLD

**368**



**GELATARIA**  
CLACERIE  
HELADERÍA  
ICE-CREAM

**504**



**PREVENÇÃO E SAÚDE**  
PRÉVENTION ET SANTÉ  
PREVENCION Y SALUD  
PREVENTION AND HEALTH

**525**



[www.udex.pt](http://www.udex.pt)

<p>20 21 24 25 26 48 49 51</p> 	<p>22 27 49 53</p> 	<p>28</p> 	<p>30 32</p> 
<p>42</p> 	<p>54</p> 	<p>56</p> 	<p>57</p> 
<p>59</p> 	<p>65</p> 	<p>66</p> 	<p>67</p> 
<p>68</p> 	<p>69</p> 	<p>70</p> 	<p>71</p> 
<p>72</p> 	<p>73</p> 	<p>74</p> 	<p>75</p> 
<p>76</p> 	<p>83</p> 	<p>84</p> 	<p>86</p> 



<p><b>88</b></p> 	<p><b>88</b></p> 	<p><b>90</b></p> 	<p><b>90</b></p> 
<p><b>91</b></p> 	<p><b>98</b></p> 	<p><b>100</b></p> 	<p><b>102</b></p> 
<p><b>104</b></p> 	<p><b>106</b></p> 	<p><b>108</b></p> 	<p><b>109</b></p> 
<p><b>110</b></p> 	<p><b>112</b></p> 	<p><b>113</b></p> 	<p><b>114</b></p> 
<p><b>115</b></p> 	<p><b>116</b></p> 	<p><b>117</b></p> 	<p><b>118</b></p> 
<p><b>119</b></p> 	<p><b>120</b></p> 	<p><b>125</b></p> 	<p><b>126</b></p> 

<p><b>129</b></p> 	<p><b>134</b></p> 	<p><b>135</b></p> 	<p><b>135</b></p> 
<p><b>136</b></p> 	<p><b>137</b></p> 	<p><b>137</b></p> 	<p><b>138</b></p> 
<p><b>139</b></p> 	<p><b>140</b></p> 	<p><b>142</b></p> 	<p><b>144</b></p> 
<p><b>146</b></p> 	<p><b>147</b></p> 	<p><b>148</b></p> 	<p><b>149</b></p> 
<p><b>152</b></p> 	<p><b>159</b></p> 	<p><b>160</b></p> 	<p><b>161</b></p> 
<p><b>162</b></p> 	<p><b>164</b></p> 	<p><b>165</b></p> 	<p><b>166</b></p> 

**167**



**173**



**174  
214**



**176  
216**



**177  
217**



**178  
217**



**179**



**180  
218**



**182  
220**



**182  
220**



**183  
184  
221  
222**



**184  
222**



**185  
223**



**186  
224**



**187  
225**



**188  
226**



**204  
246**



**251**

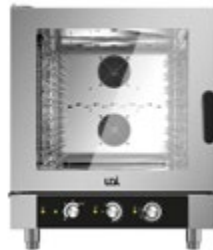

**252**



**258**



**260**



**262**



**265**



**276**



<p><b>277</b></p> 	<p><b>280</b></p> 	<p><b>282</b></p> 	<p><b>283</b></p> 
<p><b>286</b></p> 	<p><b>287</b></p> 	<p><b>288</b></p> 	<p><b>290</b></p> 
<p><b>293</b></p> 	<p><b>294</b></p> 	<p><b>295</b></p> 	<p><b>297</b></p> 
<p><b>303</b></p> 	<p><b>306</b></p> 	<p><b>312</b></p> 	<p><b>320</b></p> 
<p><b>322</b></p> 	<p><b>325</b></p> 	<p><b>328</b></p> 	<p><b>330</b></p> 
<p><b>334</b></p> 	<p><b>336</b></p> 	<p><b>339</b></p> 	<p><b>346</b></p> 

<p><b>350</b></p> 	<p><b>352</b> <b>353</b> <b>354</b> <b>355</b> <b>358</b> <b>359</b></p> 	<p><b>364</b></p> 	<p><b>365</b></p> 
<p><b>370</b></p> 	<p><b>371</b></p> 	<p><b>389</b></p> 	<p><b>390</b></p> 
<p><b>401</b></p> 	<p><b>404</b></p> 	<p><b>412</b></p> 	<p><b>416</b></p> 
<p><b>424</b></p> 	<p><b>427</b></p> <p><b>SUPERMERCADO</b></p> 	<p><b>430</b></p> 	<p><b>432</b></p> 
<p><b>443</b></p> 	<p><b>444</b></p> 	<p><b>445</b></p> 	<p><b>446</b></p> 
<p><b>447</b></p> 	<p><b>448</b></p> 	<p><b>449</b></p> 	<p><b>451</b></p> 

<p><b>452</b></p> 	<p><b>454</b></p> 	<p><b>456</b></p> 	<p><b>457</b></p> 
<p><b>460</b></p> 	<p><b>469</b></p> 	<p><b>470</b></p> 	<p><b>476</b></p> 
<p><b>482</b></p> 	<p><b>483</b></p> 	<p><b>484</b></p> 	<p><b>486</b></p> 
<p><b>490</b></p> 	<p><b>491</b></p> 	<p><b>504</b></p> 	<p><b>507</b></p> 
<p><b>511</b></p> 	<p><b>512</b></p> 	<p><b>517</b></p> 	<p><b>518</b></p> 
<p><b>520</b></p> 	<p><b>521</b></p> 	<p><b>525</b></p> 	<p><b>526</b></p> 

ÍNDICE DE SEGMENTOS  
INDEX DES SEGMENTS  
ÍNDICE DE SEGMENTOS  
SEGMENT INDEX



**LAVAGEM**  
LAVAGE  
LAVADO  
WASHING

**20**



**RESTAURAÇÃO / COZEDURA**  
RESTAURATION / CUISSON  
RESTAURACIÓN / COCCIÓN  
RESTAURANT INDUSTRY / COOKING

**59**



**PIZZARIA / PADARIA / PASTELARIA**  
PIZZERIA / BOULANGERIE / PÂTISSERIE  
PIZZERÍA / PANADERÍA / PASTELERÍA  
PIZZERIA / BAKERY / PASTRY

**312**



**FRIO**  
FROID  
FRÍO  
COLD

**368**



**GELATARIA**  
CLACERIE  
HELADERÍA  
ICE-CREAM

**504**



**PREVENÇÃO E SAÚDE**  
PRÉVENTION ET SANTÉ  
PREVENCION Y SALUD  
PREVENTION AND HEALTH

**525**



[www.udex.pt](http://www.udex.pt)

# ECO-FRIENDLY AMIGOS DO AMBIENTE

A UDEX está empenhada com a proteção do nosso meio ambiente através da comercialização e utilização de equipamentos que recorram a tecnologias limpas e que substituam substâncias nocivas por alternativas mais ecológicas.

UDEX is committed in protecting our environment through the commercialization and usage of equipment that relies upon clean technologies and that replace harmful substances with more ecological alternatives.







www.udex.pt



## www.udex.pt

- ✓ Design Responsivo
- ✓ Catálogo de Equipamentos Online
- ✓ Cesto de Compras
- ✓ Newsletter
- ✓ Área de Notícias
- ✓ Área de Downloads

- Responsive Design
- Online Equipment Catalog
- Shopping basket
- Newsletter
- News Area
- Downloads

## APP Udex

A UDEX inova no setor hoteleiro na Península Ibérica. Com a APP Udex colocamos na sua mão recursos simples, práticos e evolutivos que o ajudam diariamente.

UDEX innovates in the hotel sector in the Iberian Peninsula. With the UDEX APP we put in the palm of your hand a simple, practical and evolutionary resources that help you daily.





# LAVAGEM DE LOUÇA

## MARCA DE PRESTÍGIO E FABRICO EUROPEU

As máquinas de lavar louça DIHR oferecem uma ampla gama de modelos, equipados com tecnologias inovadoras e projetados com electrónica de vanguarda. O nosso objetivo é reduzir o consumo energético, água e produtos químicos, garantindo economia ao utilizador final, mas também menos poluição e desperdício de recursos naturais.

### DISH WASHING

#### PRESTIGE BRAND AND EUROPEAN MANUFACTURE

The DIHR dishwashers offer a wide range of models, all equipped with innovative technologies and avant-garde electronic designs. Our goal is to reduce energy, water and chemical consumption, thus ensuring saving costs for the end user, but also less pollution and waste of natural resources.

GAMA DISPONÍVEL  
NO WEBSITE  
PRODUCT LINE AVAILABLE ON  
THE WEBSITE







Estrutura de aço inoxidável sólido  
 AISI 304  
 Porta de parede dupla  
 Porta de micro segurança em caso de  
 abertura accidental



Structure solide en acier inoxydable  
 AISI 304  
 Porte double de mur  
 Micro porte de sécurité en cas  
 d'ouverture accidentelle



Estructura sólida de acero inoxidable  
 AISI 304  
 Puerta de doble pared  
 Micro puerta de seguridad en caso de  
 apertura accidental



Solid stainless steel structure AISI  
 304  
 Double wall door  
 Micro safety door in case of accidental  
 opening



MODELO / MODÈLE / MODELO / MODEL CÓDIGO / CODE / CÓDIGO / CODE		GS 35 2800.002
<b>Preço / Prix / Precio / Price</b>	€	<b>1.281,00</b>
Dimensões / Dimensions / Dimensiones	mm	400x495x585
Dimensões cesto / Dim. Panier/ Dim. Cesto / Basket dim	mm	350x350
Alt. Max. Copos / Haut. Max. Verres / Alt. Max. Vajillas / Max. Height Glass	mm	195
Cestos-hora / Paniers-heure / Cestos - hora / Racks-hour	nr (55°C)	30
Cons. Água p/ ciclos / Cons. D'eau p/ cycle / Cons. Agua p/ ciclo / Cycle water cons.	lt	1,4
Duração dos ciclos / Duration cycles / Duración ciclos / Cycles duration	seg.	120 (1)
Peso Líquido /Poids Net /Peso Neto /Net Weight	kg	29
Potência Total / Puissance Total / Potência Total / Total Power	kW	2,6
Tensão / Tension / Tension / Tension	V	230



MODELO / MODÈLE / MODELO / MODEL CÓDIGO / CODE / CÓDIGO / CODE		GS 37 2800.004	GS 37 LS 2800.004B
<b>Preço / Prix / Precio / Price</b>	€	<b>1.852,00</b>	<b>2.020,00</b>
Dimensões / Dimensions / Dimensiones	mm	420x490x650	420x490x650
Dimensões cesto / Dim. Panier/ Dim. Cesto / Basket dim	mm	370x370	370x370
Alt. Max. Copos / Haut. Max. Verres / Alt. Max. Vajillas / Max. Height Glass	mm	275	275
Alt. Max. Pratos / Haut. Max. Aissietes / Alt. Max. Platos / Max. Height Dishes	mm	-	280
Cestos-hora / Paniers-heure / Cestos - hora / Racks-hour	nr (55°C)	30	30
Cons. Água p/ ciclos / Cons. D'eau p/ cycle / Cons. Agua p/ ciclo / Cycle water cons.	lt	1,8	1,8
Duração dos ciclos / Duration cycles / Duración ciclos / Cycles duration	seg.	120 (1)	120 (1)
Peso Líquido /Poids Net /Peso Neto /Net Weight	kg	32,5	32,5
Potência Total / Puissance Total / Potência Total / Total Power	kW	2,8	2,8
Tensão / Tension / Tension / Tension	V	230	230



MODELO / MODÈLE / MODELO / MODEL CÓDIGO / CODE / CÓDIGO / CODE		GS 40 2800.006	GS 40 LS 2800.006B
<b>Preço / Prix / Precio / Price</b>	€	<b>1.857,00</b>	<b>2.049,00</b>
Dimensões / Dimensions / Dimensiones	mm	450x535x700	450x535x700
Dimensões cesto / Dim. Panier/ Dim. Cesto / Basket dim	mm	400x400	400x400
Alt. Max. Copos / Haut. Max. Verres / Alt. Max. Vajillas / Max. Height Glass	mm	305	305
Alt. Max. Pratos / Haut. Max. Aissietes / Alt. Max. Platos / Max. Height Dishes	mm	-	295
Cestos-hora / Paniers-heure / Cestos - hora / Racks-hour	nr (55°C)	30	30
Cons. Água p/ ciclos / Cons. D'eau p/ cycle / Cons. Agua p/ ciclo / Cycle water cons.	lt	1,8	1,8
Duração dos ciclos / Duration cycles / Duración ciclos / Cycles duration	seg.	120 (1)	120 (1)
Peso Líquido /Poids Net /Peso Neto /Net Weight	kg	38,5	38,5
Potência Total / Puissance Total / Potência Total / Total Power	kW	3,2	3,2
Tensão / Tension / Tension / Tension	V	230	230



MODELO / MODÈLE / MODELO / MODEL CÓDIGO / CODE / CÓDIGO / CODE		GS 50 ECO 2800.008	GS 50 2800.010
<b>Preço / Prix / Precio / Price</b>	€	<b>2.441,00</b>	<b>2.477,00</b>
Dimensões / Dimensions / Dimensiones	mm	590x600x850	590x600x850
Dimensões cesto / Dim. Panier/ Dim. Cesto / Basket dim	mm	500x500	500x500
Alt. Max. Copos / Haut. Max. Verres / Alt. Max. Vajillas / Max. Height Glass	mm	320	320
Alt. Max. Pratos / Haut. Max. Aissietes / Alt. Max. Platos / Max. Height Dishes	mm	345	345
Cestos-hora / Paniers-heure / Cestos - hora / Racks-hour	nr (55 °C)	30	30/20
Cons. Água p/ ciclos / Cons. D'eau p/ cycle / Cons. Agua p/ ciclo / Cycle water cons.	lt	2,3	2,3
Duração dos ciclos / Duration cycles / Duración ciclos / Cycles duration	seg	120 (1)	120 (1) / 180 (2)
Peso Líquido /Poids Net /Peso Neto /Net Weight	kg	57	57
Potência Total / Puissance Total / Potência Total / Total Power	kW	3,5	5,2
Tensão / Tension / Tension / Tension	V	230	400

seg. - segundos / secondes / segundos / seconds

OPCIONAIS LAVAGEM / OPTIONNELLES LAVAGE / OPCIONALES LAVADO / WASHING OPTIONALS 42>45

**DIHR**

**MÁQUINAS DE LAVAR - PAREDE SIMPLÉS**  
 LAVE VERRES ET VAISSELLES AVEC PAROI SIMPLE  
 LAVAVAJILLAS Y PLATOS CON MONO CARROCERIA  
 SIMPLE WALL GLASS AND DISH WASHERS



Versão electrónica com 4 programas de lavagem. Painel de comandos LED, com visualização da temperatura de lavagem e enxaguamento, programa em curso e principais códigos de erros.



Version électronique avec 4 programmes de lavage. Panneau de contrôle à LED, avec visualisation de la température de lavage et de rinçage, programme en cours et principaux codes d'erreur.



Versión electrónica con 4 programas de lavado. Panel de control LED, con visualización la temperatura de lavado y aclarado, programa en curso y principales códigos de error de falla.



Electronic version with 4 preset washing programs. The LED panel displays the temperatures of both tank and boiler, the wash cycle and status and main fault error codes.

**NOVO  
NOUVEAU  
NUEVO  
NEW**



MODELO / MODÈLE / MODELO / MODEL CÓDIGO / CODE / CÓDIGO / CODE		GS 40 T 2800.452	GS 40 T LS 2800.454
<b>Preço / Prix / Precio / Price</b>	€	<b>2.019,00</b>	<b>2.152,00</b>
Dimensões / Dimensions / Dimensiones	mm	450x535x700	450x535x700
Dimensões cesto / Dim. Panier/ Dim. Cesto / Basket dim	mm	400x400	400x400
Alt. Max. Copos / Haut. Max. Verres / Alt. Max. Vajillas / Max. Height Glass	mm	305	305
Alt. Max. Pratos / Haut. Max. Aissietes / Alt. Max. Platos / Max. Height Dishes	mm	-	295
Cestos-hora / Paniers-heure / Cestos - hora / Racks-hour	nr (55 °C)	60/40/30/20	60/40/30/20
Duração dos ciclos / Duration cycles / Duración ciclos / Cycles duration	seg	60(1)/90(2) /120(3)/180(4)	60(1)/90(2) /120(3)/180(4)
Cons. Água p/ ciclos / Cons. D'eau p/ cycle / Cons. Agua p/ ciclo / Cycle water cons.	lt	1,8	1,8
Peso Líquido / Poids Net / Peso Neto / Net Weight	kg	37	37
Potência Total / Puissance Total / Potência Total / Total Power	kW	3,2	3,2
Tensão / Tension / Tension / Tension	V	230	230

**NOVO  
NOUVEAU  
NUEVO  
NEW**



MODELO / MODÈLE / MODELO / MODEL CÓDIGO / CODE / CÓDIGO / CODE		GS 50 T 2800.456
<b>Preço / Prix / Precio / Price</b>	€	<b>2.632,00</b>
Dimensões / Dimensions / Dimensiones	mm	590x600x850
Dimensões cesto / Dim. Panier/ Dim. Cesto / Basket dim	mm	500x500
Alt. Max. Copos / Haut. Max. Verres / Alt. Max. Vajillas / Max. Height Glass	mm	320
Alt. Max. Pratos / Haut. Max. Aissietes / Alt. Max. Platos / Max. Height Dishes	mm	345
Cestos-hora / Paniers-heure / Cestos - hora / Racks-hour	nr (55 °C)	60/40/30/20
Duração dos ciclos / Duration cycles / Duración ciclos / Cycles duration	seg	60(1)/90(2) /120(3)/180(4)
Cons. Água p/ ciclos / Cons. D'eau p/ cycle / Cons. Agua p/ ciclo / Cycle water cons.	lt	2,3
Peso Líquido / Poids Net / Peso Neto / Net Weight	kg	56,5
Potência Total / Puissance Total / Potência Total / Total Power	kW	5,2
Tensão / Tension / Tension / Tension	V	400

**NOVO  
NOUVEAU  
NUEVO  
NEW**



MODELO / MODÈLE / MODELO / MODEL CÓDIGO / CODE / CÓDIGO / CODE		GS 85 T 2800.458
<b>Preço / Prix / Precio / Price</b>	€	<b>2.898,00</b>
Dimensões / Dimensions / Dimensiones	mm	590x600x1290
Dimensões cesto / Dim. Panier/ Dim. Cesto / Basket dim	mm	500x500
Alt. Max. Copos / Haut. Max. Verres / Alt. Max. Vajillas / Max. Height Glass	mm	355
Alt. Max. Pratos / Haut. Max. Aissietes / Alt. Max. Platos / Max. Height Dishes	mm	380
Cestos-hora / Paniers-heure / Cestos - hora / Racks-hour	nr (55 °C)	60/40/30/20
Cons. Água p/ ciclos / Cons. D'eau p/ cycle / Cons. Agua p/ ciclo / Cycle water cons.	lt	2,3
Duração dos ciclos / Duration cycles / Duración ciclos / Cycles duration	seg	60 (1) / 90 (2) / 120 (3) / 180 (4)
Peso Líquido / Poids Net / Peso Neto / Net Weight	kg	68,5
Potência Total / Puissance Total / Potência Total / Total Power	kW	6,9
Tensão / Tension / Tension / Tension	V	400

**NOVO  
NOUVEAU  
NUEVO  
NEW**



MODELO / MODÈLE / MODELO / MODEL CÓDIGO / CODE / CÓDIGO / CODE		HT 11 T 2800.460	HT 11 IT* 2800.462
<b>Preço / Prix / Precio / Price</b>	€	<b>4.363,00</b>	<b>4.723,00</b>
Dimensões / Dimensions / Dimensiones	mm	720x735x1445/ 1880	720x735x1445/ 1880
Dimensões cesto / Dim. Panier/ Dim. Cesto / Basket dim	mm	500x500	500x500
Alt. Max. Pratos / Haut. Max. Aissietes / Alt. Max. Platos / Max. Height Dishes	mm	410	410
Cestos-hora / Paniers-heure / Cestos - hora / Racks-hour	nr (55 °C)	72/45/30/20	72/45/30/20
Duração dos ciclos / Duration cycles / Duración ciclos / Cycles duration	seg	50(1)/80(2)/ 120(3)/180(4)	50(1)/80(2)/ 120(3)/180(4)
Peso Líquido / Poids Net / Peso Neto / Net Weight	kg	100	100
Potência Total / Puissance Total / Potência Total / Total Power	kW	10,12	10,12
Tensão / Tension / Tension / Tension	V	400	400

\* **capota isolada / insulated hood**  
seg - segundos / secondes / segundos / seconds

OPCIONAIS LAVAGEM / OPTIONNELLES LAVAGE / OPCIONALES LAVADO / WASHING OPTIONALS 42>45

# HT



HT 12 E = 5 Programas + Electrónica PLUS - Sistema que garante lavagem com temperatura e pressão constantes



HT 12 E = 5 Programmes + Electronique PLUS - Système qui garantit un lavage à température et pression constante



HT 12 E = 5 programas + electrónica PLUS - Sistema que garantiza un lavado a temperatura y presión constante



HT 12 E = 5 Programs + Electronics PLUS - System that guarantees constant temperature and pressure washing



MODELO / MODÈLE / MODELO / MODEL CÓDIGO / CODE / CÓDIGO / CODE		HT 11 2800.060
<b>Preço / Prix / Precio / Price</b>	<b>€</b>	<b>4.212,00</b>
Dimensões / Dimensions / Dimensiones	mm	720X735X 1445/1880
Dimensões cesto / Dim. Panier/ Dim. Cesto / Basket dim	mm	500X500 (GN)
Alt. Max. Pratos / Haut. Max. Aissietes / Alt. Max. Platos / Max. Height Dishes	mm	410
Cestos-hora / Paniers-heure / Cestos - hora / Racks-hour	nr (55°C)	70/30
Ciclos / Cycles / Ciclos / Cycles	seg	50(1) / 120 (2)
Peso Líquido / Poids Net / Peso Neto / Net Weight	kg	100
Potência Total / Puissance Total / Potência Total / Total Power	kW	10,2
Tensão / Tension / Tension / Tension	V	400



MODELO / MODÈLE / MODELO / MODEL CÓDIGO / CODE / CÓDIGO / CODE		HT 12 ELECTRON 2 2800.064B
<b>Preço / Prix / Precio / Price</b>	<b>€</b>	<b>6.279,00</b>
Dimensões / Dimensions / Dimensiones	mm	720X735X 1445/1880
Dimensões cesto / Dim. Panier/ Dim. Cesto / Basket dim	mm	500X500 (GN)
Alt. Max. Pratos / Haut. Max. Aissietes / Alt. Max. Platos / Max. Height Dishes	mm	410
Cestos-hora / Paniers-heure / Cestos - hora / Racks-hour	nr (55°C)	60 / 40/30/20
Ciclos / Cycles / Ciclos / Cycles	seg	50(1) / 90 (2) / 120(3) / 180(4)
Peso Líquido / Poids Net / Peso Neto / Net Weight	kg	113
Potência Total / Puissance Total / Potência Total / Total Power	kW	10,5
Tensão / Tension / Tension / Tension	V	400

**NOVO  
NOUVEAU  
NUEVO  
NEW**



MODELO / MODÈLE / MODELO / MODEL CÓDIGO / CODE / CÓDIGO / CODE		HT 12 E PLUS H+ 2800.068
<b>Preço / Prix / Precio / Price</b>	<b>€</b>	<b>7.561,00</b>
Dimensões / Dimensions / Dimensiones	mm	720X735X 1445/1880
Dimensões cesto / Dim. Panier/ Dim. Cesto / Basket dim	mm	500X500 (GN)
Alt. Max. Pratos / Haut. Max. Aissietes / Alt. Max. Platos / Max. Height Dishes	mm	410
Cestos-hora / Paniers-heure / Cestos - hora / Racks-hour	nr (55°C)	72/40/30/20/20/5
Ciclos / Cycles / Ciclos / Cycles	seg	50(1)/90(2)/120(3)/180(4)/180(5)/630(6)
Peso Líquido / Poids Net / Peso Neto / Net Weight	kg	115
Potência Total / Puissance Total / Potência Total / Total Power	kW	10,5
Tensão / Tension / Tension / Tension	V	400

seg. - segundos / secondes / segundos / seconds

OPCIONAIS LAVAGEM / OPTIONNELLES LAVAGE / OPCIONALES LAVADO / WASHING OPTIONALS 42>45

GASTRONORM  
1/1

530x325



confirmar disponibilidade  
confirmer la disponibilité  
confirmar la disponibilidad  
confirm the availability



①

 Misturadora bancada com duche  
 Mixer de plain de travail avec robinet  
 Mezclador sobremesa con grifo  
 Top range mixer with tap

MODELO / MODÈLE / MODELO / MODEL	V -1583
CÓDIGO / CODE / CÓDIGO / CODE	2025.028
Preço / Prix / Precio / Price	€ 340,00

②

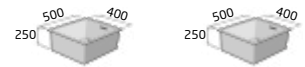

MODELO / MODÈLE / MODELO / MODEL	ENTRADA / ENTRÉE / ENTRADA / ENTRY	
CÓDIGO / CODE / CÓDIGO / CODE	2236.906	2236.908
Preço / Prix / Precio / Price	€ 1.106,00	1.286,00
Dimensões / Dimensions / Dimensiones	mm 1200x735x850	1500x735x850

③

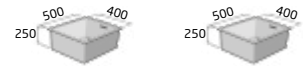

MODELO / MODÈLE / MODELO / MODEL	ENTRADA / ENTRÉE / ENTRADA / ENTRY	
CÓDIGO / CODE / CÓDIGO / CODE	2236.906DX	2236.908DX
Preço / Prix / Precio / Price	€ 1.106,00	1.286,00
Dimensões / Dimensions / Dimensiones	mm 1200x735x850	1500x735x850

④



MODELO / MODÈLE / MODELO / MODEL	SAÍDA / SORTIE / SALIDA / WAY OUT	
CÓDIGO / CODE / CÓDIGO / CODE	2236.904	
Preço / Prix / Precio / Price	€ 566,00	
Dimensões / Dimensions / Dimensiones	mm 650x735x850	

⑤



MODELO / MODÈLE / MODELO / MODEL	SAÍDA / SORTIE / SALIDA / WAY OUT	
CÓDIGO / CODE / CÓDIGO / CODE	2236.904SX	
Preço / Prix / Precio / Price	€ 566,00	
Dimensões / Dimensions / Dimensiones	mm 650x735x850	

## DS

Estrutura de parede dupla de aço inoxidável AISI 304.  
 Suporte de cesto integrado.  
 Porta de micro segurança em caso de abertura accidental.

Structure à double paroi en acier inoxydable AISI 304.  
 Support panier intégré.  
 Micro porte blindée en cas d'ouverture accidentelle.

Estructura de doble pared en acero inoxidable AISI 304.  
 Soporte de cesta integrado.  
 Micro puerta de seguridad en caso de apertura accidental.

Double wall structure in AISI 304 stainless steel.  
 Integrated basket support.  
 Micro security door in case of accidental opening.

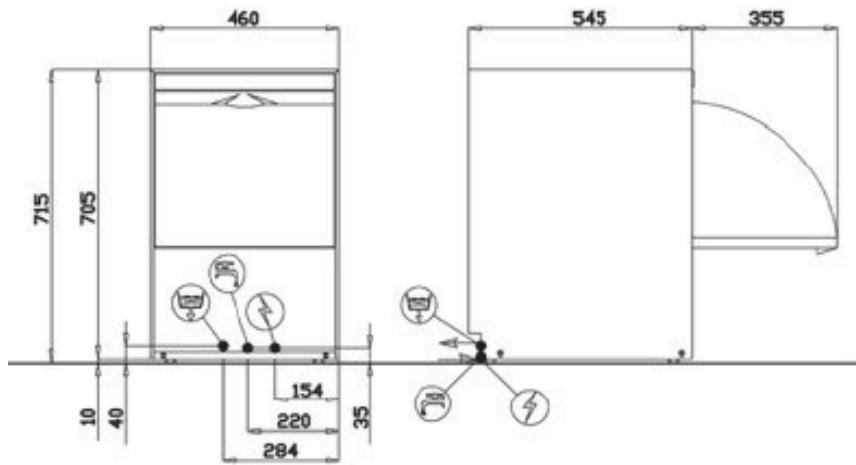

480/h - 360/h  
 (DS40)



MODELO / MODÈLE / MODELO / MODEL		DS 40
CÓDIGO / CODE / CÓDIGO / CODE		2800.020
<b>Preço / Prix / Precio / Price</b>	€	<b>2.477,00</b>
Dimensões / Dimensions / Dimensiones	mm	460x545X 715
Dimensões cesto / Dim. Panier/ Dim. Cesto / Basket dim	mm	400X400
Alt. Max. Copos / Haut. Max. Verres / Alt. Max. Vajillas / Max. Height Glass	mm	305
Cestos-hora / Paniers-heure / Cestos - hora / Racks-hour	nr (55°C)	30
Cons. Água p/ ciclos / Cons. D'eau p/ cycle / Cons. Agua p/ ciclo / Cycle water cons.	lt	1,8
Duração dos ciclos / Duration cycles / Duración ciclos / Cycles duration	seg	120 (1)
Peso Líquido / Poids Net / Peso Neto / Net Weight	kg	38
Potência Total / Puissance Total / Potência Total / Total Power	kW	3,2
Tensão / Tension / Tension / Tension	V	230

seg. - segundos / secondes / segundos / seconds

OPCIONAIS LAVAGEM / OPTIONNELLES LAVAGE / OPCIONALES LAVADO / WASHING OPTIONALS 42>45

confirmar disponibilidade  
 confirmer la disponibilité  
 confirmar la disponibilidad  
 confirm the availability



**DIHR**

**MÁQUINAS DE LAVAR - PAREDE DUPLA**  
 LAVE VERRES ET VAISSELLES - DOUBLE PAROI  
 LAVAVAJILLAS Y PLATOS - PARED DOBLE  
 GLASSWASHERS AND DISHWASHERS - DOUBLE SKIN

**TEKNO**

Silenciosa + Económica  
 Silence + Economic

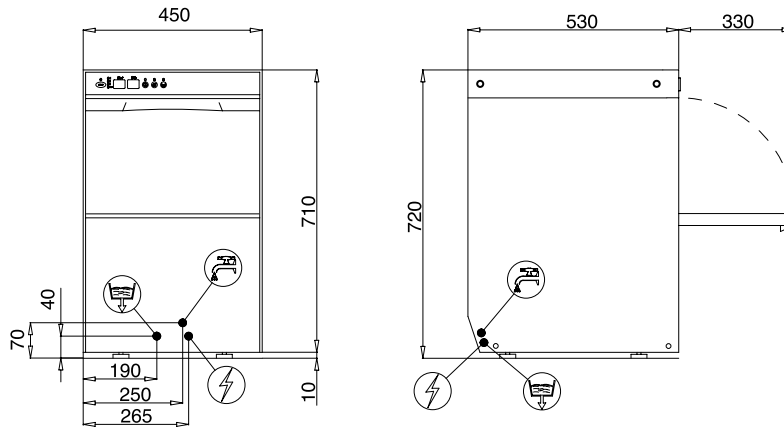
**ELECTRON 400**

MODELO / MODÈLE / MODELO / MODEL CÓDIGO / CODE / CÓDIGO / CODE		ELECTRON 400 2800.036	ELECTRON 400D 2800.036A
<b>Preço / Prix / Precio / Price</b>	<b>€</b>	<b>3.616,00</b>	<b>3.886,00</b>
Dimensões / Dimensions / Dimensiones	mm	450X530X720	450X530X720
Dimensões cesto / Dim. Panier/ Dim. Cesto / Basket dim	mm	400X400	400X400
Alt. Max. Copos / Haut. Max. Verres / Alt. Max. Vajillas / Max. Height Glass	mm	260	260
Alt. Max. Pratos / Haut. Max. Aissietes / Alt. Max. Platos / Max. Height Dishes	mm	260	260
Cestos-hora / Paniers-heure / Cestos - hora / Racks-hour	nr (55°C)	43/30/20/12	43/30/20/12
Cons. Água p/ ciclos / Cons. D'eau p/ cycle / Cons. Agua p/ ciclo / Cycle water cons.	lt	1,8	1,8
Duração dos ciclos / Duration cycles / Duración ciclos / Cycles duration	seg	60 (1)/120 (2)/180 (3)/300 (4)	60 (1)/120 (2)/180 (3)/300 (4)
Peso Líquido / Poids Net / Peso Neto / Net Weight	kg	45	45
Potência Total / Puissance Total / Potência Total / Total Power	kW	3,1	3,1
Tensão / Tension / Tension / Tension	V	230	230



MODELO / MODÈLE / MODELO / MODEL CÓDIGO / CODE / CÓDIGO / CODE		ELECTRON 1000 2800.054
<b>Preço / Prix / Precio / Price</b>	<b>€</b>	<b>3.733,00</b>
Dimensões / Dimensions / Dimensiones	mm	600x700x1380
Dimensões cesto / Dim. Panier/ Dim. Cesto / Basket dim	mm	500x500
Alt. Max. Copos / Haut. Max. Verres / Alt. Max. Vajillas / Max. Height Glass	mm	450
Alt. Max. Pratos / Haut. Max. Aissietes / Alt. Max. Platos / Max. Height Dishes	mm	450
Cons. Água p/ ciclos / Cons. D'eau p/ cycle / Cons. Agua p/ ciclo / Cycle water cons.	lt	4
Duração dos ciclos / Duration cycles / Duración ciclos / Cycles duration	seg	60/120/180/240
Peso Líquido-Bruto / Poids Net-Brut / Peso Neto-Bruto / Net-Gross Weight	kg	90-95
Potência Total / Puissance Total / Potência Total / Total Power	kW	10,2
Tensão / Tension / Tension / Tension	V	400

seg - segundos / secondes / segundos / seconds

OPCIONAIS LAVAGEM / OPTIONNELLES LAVAGE / OPCIONALES LAVADO / WASHING OPTIONALS 42>45



## OPTIMA

 Sistema Tratamento por Osmose  
 O tratamento para sistemas de osmose reversa retém de 95% a 99% dos sais minerais e microorganismos normalmente presentes na água que alimenta a máquina; tudo isso é possível graças a membranas semipermeáveis e sem a necessidade de produtos químicos. Alimentar a sua máquina OPTIMA com água osmótica, em combinação com um detergente adequado, melhorar significativamente os resultados da lavagem: pratos e copos estarão livres de marcas e manchas desagradáveis e não precisarão ser limpos novamente com o pano uma vez seco.

 Système de traitement par osmose  
 Le traitement des systèmes d'osmose inverse retient 95 à 99 % des sels minéraux et des micro-organismes normalement présents dans l'eau qui alimente la machine ; tout cela est possible grâce aux membranes semi-perméables et sans besoin de produits chimiques. L'alimentation de votre machine OPTIMA avec de l'eau osmotique, associée à un détergent adapté, améliorera considérablement les résultats de lavage : assiettes et verres seront exempts de marques et de taches disgracieuses et n'auront plus besoin d'être essuyés avec le chiffon une fois secs.

 Sistema de tratamiento de ósmosis  
 El tratamiento para sistemas de ósmosis inversa retiene del 95% al 99% de las sales minerales y microorganismos normalmente presentes en el agua que alimenta la máquina; todo esto es posible gracias a membranas semipermeables y sin necesidad de productos químicos. Alimentar su máquina OPTIMA con agua osmótica, en combinación con un detergente adecuado, mejorará significativamente los resultados del lavado: platos y vasos estarán libres de marcas y manchas antiestéticas y no será necesario volver a limpiar con el paño una vez secos.

 Osmosis Treatment System  
 Treatment for reverse osmosis systems retains 95% to 99% of the mineral salts and microorganisms normally present in the water that feeds the machine; all this is possible thanks to semi-permeable membranes and without the need for chemicals. Feeding your OPTIMA machine with osmotic water, in combination with a suitable detergent, will significantly improve the washing results: plates and glasses will be free from unsightly marks and stains and will not need to be wiped again with the cloth once dry.

**OPTIMA2  
400**



MODELO / MODÈLE / MODELO / MODEL CÓDIGO / CODE / CÓDIGO / CODE		OPTIMA2 400 2800.132
<b>Preço / Prix / Precio / Price</b>	€	<b>4.575,00</b>
Dimensões / Dimensions / Dimensiones	mm	460x550x780
Dimensões cesto / Dim. Panier/ Dim. Cesto / Basket dim	mm	400x400
Alt. Max. Copos / Haut. Max. Verres / Alt. Max. Vajillas / Max. Height Glass	mm	310
Alt. Max. Pratos / Haut. Max. Aissietes / Alt. Max. Platos / Max. Height Dishes	mm	310
Peso Líquido / Poids Net / Peso Neto / Net Weight	kg	50
Potência Total / Puissance Total / Potência Total / Total Power	kW	3,25
Tensão / Tension / Tension / Tension	V	230

**OPTIMA2  
500**



MODELO / MODÈLE / MODELO / MODEL CÓDIGO / CODE / CÓDIGO / CODE		OPTIMA2 500 2800.133
<b>Preço / Prix / Precio / Price</b>	€	<b>4.903,00</b>
Dimensões / Dimensions / Dimensiones	mm	600x610x850
Dimensões cesto / Dim. Panier/ Dim. Cesto / Basket dim	mm	500x500
Alt. Max. Copos / Haut. Max. Verres / Alt. Max. Vajillas / Max. Height Glass	mm	340(GN)
Alt. Max. Pratos / Haut. Max. Aissietes / Alt. Max. Platos / Max. Height Dishes	mm	340
Peso Líquido / Poids Net / Peso Neto / Net Weight	kg	73
Potência Total / Puissance Total / Potência Total / Total Power	kW	6,7
Tensão / Tension / Tension / Tension	V	400

**DIHR**

**MÁQUINAS DE LAVAR - OSMOSIS**  
 LAVE VERRES ET VAISSELLES - OSMOSIS  
 LAVAVAJILLAS Y PLATOS - OSMOSIS  
 GLASSWASHERS AND DISHWASHERS - OSMOSIS



# OPTIMA



Sistema Tratamento por Osmose  
 O tratamento para sistemas de osmose reversa retém de 95% a 99% dos sais minerais e microorganismos normalmente presentes na água que alimenta a máquina; tudo isso é possível graças a membranas semipermeáveis e sem a necessidade de produtos químicos. Alimentar a sua máquina OPTIMA com água osmótica, em combinação com um detergente adequado, melhorará significativamente os resultados da lavagem: pratos e copos estarão livres de marcas e manchas desagradáveis e não precisarão ser limpos novamente com o pano uma vez seco.



Système de traitement par osmose  
 Le traitement des systèmes d'osmose inverse retient 95 à 99 % des sels minéraux et des micro-organismes normalement présents dans l'eau qui alimente la machine ; tout cela est possible grâce aux membranes semi-perméables et sans besoin de produits chimiques. L'alimentation de votre machine OPTIMA avec de l'eau osmotique, associée à un détergent adapté, améliorera considérablement les résultats de lavage : assiettes et verres seront exempts de marques et de taches disgracieuses et n'auront plus besoin d'être essuyés avec le chiffon une fois secs.



Sistema de tratamiento de ósmosis  
 El tratamiento para sistemas de ósmosis inversa retiene del 95% al 99% de las sales minerales y microorganismos normalmente presentes en el agua que alimenta la máquina; todo esto es posible gracias a membranas semipermeables y sin necesidad de productos químicos. Alimentar su máquina OPTIMA con agua osmótica, en combinación con un detergente adecuado, mejorará significativamente los resultados del lavado: platos y vasos estarán libres de marcas y manchas antiestéticas y no será necesario volver a limpiar con el paño una vez secos.



Osmosis Treatment System  
 Treatment for reverse osmosis systems retains 95% to 99% of the mineral salts and microorganisms normally present in the water that feeds the machine; all this is possible thanks to semi-permeable membranes and without the need for chemicals. Feeding your OPTIMA machine with osmotic water, in combination with a suitable detergent, will significantly improve the washing results: plates and glasses will be free from unsightly marks and stains and will not need to be wiped again with the cloth once dry.



MODELO / MODÈLE / MODELO / MODEL	OS1 OSMOSIS P/ OPTIMA2 400	OS1 OSMOSIS P/ OPTIMA2 500 HT12 / HT14
CÓDIGO / CODE / CÓDIGO / CODE	2800.135	2800.135A
Preço / Prix / Precio / Price	€ 5.156,00	5.856,00



MODELO / MODÈLE / MODELO / MODEL	HT 12 OPTIMA	HT 14 OPTIMA
CÓDIGO / CODE / CÓDIGO / CODE	2800.066A	2800.066B
Preço / Prix / Precio / Price	€ 6.970,00	8.005,00
Dimensões / Dimensions / Dimensiones	mm 720x735x1445/1880	720x735x1445/1880
Dimensões cesto / Dim. Panier / Dim. Cesto / Basket dim	mm 500x500 (GN)	500x500 (GN)
Alt. Max. Pratos / Haut. Max. Aissietes / Alt. Max. Platos / Max. Height Dishes	mm 410	410
Cestos-hora / Paniers-heure / Cestos - hora / Racks-hour	(nr PD*) (nr TD*) 70/40/30/20/12	70/40/30/20/12
Duração dos ciclos / Duration cycles / Duración ciclos / Cycles duration	seg 50(1) / 90(2) / 120(3) 180(4) / 300(5)	50(1) / 90(2) / 120(3) 180(4) / 300(5)
Peso Líquido / Poids Net / Peso Neto / Net Weight	kg 115	115
Potência Total / Puissance Total / Potência Total / Total Power	kW 10,5	10,5
Tensão / Tension / Tension / Tension	V 400	400

seg - segundos / secondes / segundos / seconds



confirmar disponibilidade  
 confirmer la disponibilité  
 confirmar la disponibilidad  
 confirm the availability



opcional  
 optionnel  
 opcional  
 optional

# RX COMPACT



**RX 101**  
 Reversível  
 Réversible  
 Reversible  
 Reversible

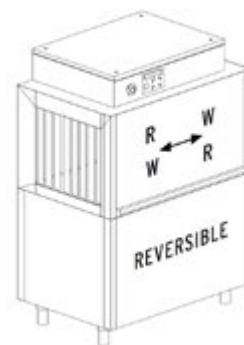

MODELO / MODÈLE / MODELO / MODEL CÓDIGO / CODE / CÓDIGO / CODE		RX 101E 2800.080
<b>Preço / Prix / Precio / Price</b>	€	<b>14.725,00</b>
Dimensões / Dimensions / Dimensiones	mm	1080x715x1565/1900
Dimensões cesto / Dim. Panier/ Dim. Cesto / Basket dim	mm	500x500
Alt. Max. Pratos / Haut. Max. Aissietes / Alt. Max. Platos / Max. Height Dishes	mm	450
Cestos-hora / Paniers-heure / Cestos - hora / Racks-hour	nr	70/100
Peso Líquido / Poids Net /Peso Neto /Net Weight	kg	210
Potência Total / Puissance Total / Potência Total / Total Power	kW	23
Tensão / Tension / Tension / Tension	V	400



MODELO / MODÈLE / MODELO / MODEL CÓDIGO / CODE / CÓDIGO / CODE		RX 101E + SECADOR DR24 2800.080A
<b>Preço / Prix / Precio / Price</b>	€	<b>18.614,00</b>
Dimensões / Dimensions / Dimensiones	mm	1680x715x1830/1900
Dimensões cesto / Dim. Panier/ Dim. Cesto / Basket dim	mm	500x500
Alt. Max. Pratos / Haut. Max. Aissietes / Alt. Max. Platos / Max. Height Dishes	mm	450
Cestos-hora / Paniers-heure / Cestos - hora / Racks-hour	nr	70/100
Peso Líquido / Poids Net /Peso Neto /Net Weight	kg	210
Potência Total / Puissance Total / Potência Total / Total Power	kW	28
Tensão / Tension / Tension / Tension	V	400



MODELO / MODÈLE / MODELO / MODEL CÓDIGO / CODE / CÓDIGO / CODE		RX 101E+DR24+SC5 2800.080B
<b>Preço / Prix / Precio / Price</b>	€	<b>22.100,00</b>
Dimensões / Dimensions / Dimensiones	mm	1980x715x1830X1900
Dimensões cesto / Dim. Panier/ Dim. Cesto / Basket dim	mm	500x500
Alt. Max. Pratos / Haut. Max. Aissietes / Alt. Max. Platos / Max. Height Dishes	mm	450
Cestos-hora / Paniers-heure / Cestos - hora / Racks-hour	nr	70/100
Peso Líquido / Poids Net /Peso Neto /Net Weight	kg	325
Potência Total / Puissance Total / Potência Total / Total Power	kW	28,5
Tensão / Tension / Tension / Tension	V	400



MODELO / MODÈLE / MODELO / MODEL CÓDIGO / CODE / CÓDIGO / CODE		RX 164E 2800.081
<b>Preço / Prix / Precio / Price</b>	€	<b>21.648,00</b>
Dimensões / Dimensions / Dimensiones	mm	1880x715x1565/1900
Dimensões cesto / Dim. Panier/ Dim. Cesto / Basket dim	mm	500x500
Alt. Max. Pratos / Haut. Max. Aissietes / Alt. Max. Platos / Max. Height Dishes	mm	450
Cestos-hora / Paniers-heure / Cestos - hora / Racks-hour	nr	100/150
Peso Líquido / Poids Net /Peso Neto /Net Weight	kg	270
Potência Total / Puissance Total / Potência Total / Total Power	kW	30
Tensão / Tension / Tension / Tension	V	400

seg. - segundos / secondes / segundos / seconds

OPCIONAIS LAVAGEM / OPTIONNELLES LAVAGE / OPCIONALES LAVADO / WASHING OPTIONALS 42>45



# RX COMPACT

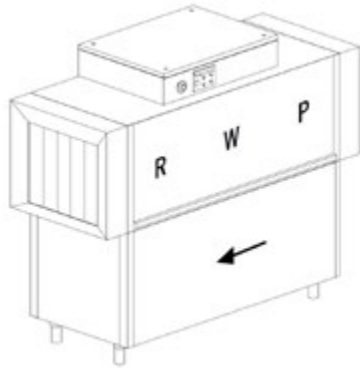

**KIT DOSEADOR**  
2800.069C  
2.344,00

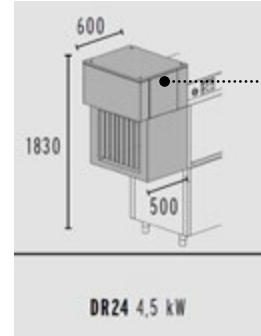

Secador  
Sécheur  
Secadora  
Dryer

**SECADOR DR24\***  
5KW  
2800.076  
4.110,00

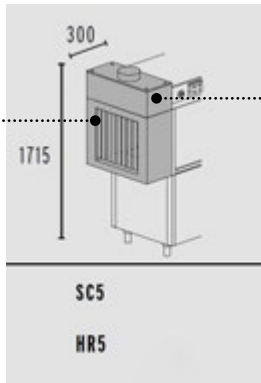

Condensador  
Condensateur  
Condensador  
Condenser

**CONDENSADOR DE VAPOR SC5**  
0,5KW  
2800.077A  
3.560,00

Recuperador Calor  
Recupérateur de chaleur  
Recuperador Calor  
Heat Recovery

**RECUPERADOR CALOR HR5**  
0,5KW  
2800.077B  
4.394,00

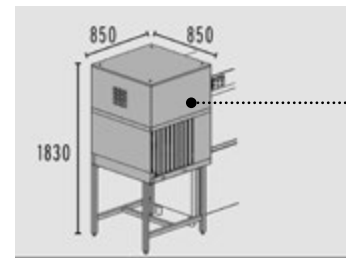

Secador  
Sécheur  
Secadora  
Dryer

Curva mecanizada 90 graus  
Courbe mécanisée à 90 degrés  
Curva mecanizada 90 grados  
Mechanized curve 90 degrees

**SECADOR DRA924**  
5KW  
2800.077  
9.200,00



Condensador  
Condensateur  
Condensador  
Condenser

Secador  
Sécheur  
Secadora  
Dryer

# LP



PLUS - Sistema que garante lavagem com temperatura e pressão constante



PLUS - système qui garantit un rinçage avec température et pression constantes



PLUS - Sistema que garantiza un aclarado con temperatura y presión constante



PLUS - A system that grants a constant rinse temperature and pressure

## LP-1 S5 PLUS

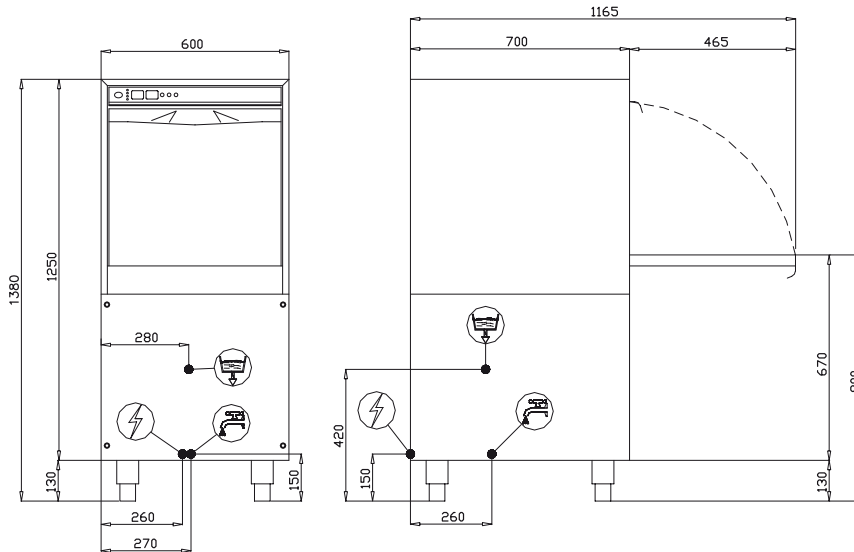

600x400



EURONORM: 600x400mm

MODELO / MODÈLE / MODELO / MODEL	LP1S5 PLUS	
CÓDIGO / CODE / CÓDIGO / CODE	2800.149	
<b>Preço / Prix / Precio / Price</b>	€	<b>6.967,00</b>
Dimensões / Dimensions / Dimensiones	mm	720x735x1445/1915
Dimensões cesto / Dim. Panier / Dim. Cesto / Basket dim	mm	500X610
Alt. Max. tabuleiros / Haut. Max. plateaux / Alt. Max. bandejas / Trays max. Height	mm	EURONORM
Cestos-hora / Paniers-heure / Cestos - hora / Racks-hour	nr(55°C)	60/30/20/12
Cons. Água p/ ciclos / Cons. D'eau p/ cycle / Cons. Agua p/ ciclo / Cycle water cons.	lt	2,6
Duração dos ciclos / Duration cycles / Duración ciclos / Cycles duration	seg	60(1) / 120(2) / 180(3) / 300(4)
Peso Líquido / Poids Net / Peso Neto / Net Weight	kg	99
Potência Total / Puissance Total / Potência Total / Total Power	kW	10,1
Tensão / Tension / Tension / Tension	V	400

seg - segundos / secondes / segundos / seconds

OPCIONAIS LAVAGEM / OPTIONNELLES LAVAGE / OPCIONALES LAVADO / WASHING OPTIONALS 42>45

**DIHR****MÁQUINAS DE LAVAR UTENSÍLIOS DE PASTELARIA E OUTROS**LAVE-OBJETS DE PATISSERIE ET AUTRES  
LAVA-OBJETOS DE PASTELERÍA Y OTROS  
WAREWASHERS FOR PASTRY AND OTHERS**LP****Parede Simples**  
Double Simple  
Pared simple  
Simple Wall

MODELO / MODÈLE / MODELO / MODEL		LP1800	LP1800 DDE*
CÓDIGO / CODE / CÓDIGO / CODE		2800.150	2800.151
<b>Preço / Prix / Precio / Price</b>	<b>€</b>	<b>8.065,00</b>	<b>8.411,00</b>
Dimensões / Dimensions / Dimensiones	mm	650X750X 1690/2070	650X750X 1690/2070
Dimensões cesto / Dim. Panier/ Dim. Cesto / Basket dim	mm	550X665	550X665
Alt. Max. tabuleiros / Haut. Max. plateaux / Alt. Max. bandejas / Trays max. Height	mm	805	805
Cestos-hora / Paniers-heure / Cestos - hora / Racks-hour	nr (55°C)	30/15/10/7,5/6	30/15/10/7,5/6
Cons. Água p/ ciclos / Cons. D'eau p/ cycle / Cons. Agua p/ ciclo / Cycle water cons.	lt	4,7	4,7
Duração dos ciclos / Duration cycles / Duración ciclos / Cycles duration	min.	2(1)/4(2)/6(3) /8(4) / 10(5)	2(1)/4(2)/6(3) /8(4) / 10(5)
Peso Líquido / Poids Net / Peso Neto / Net Weight	kg	110	110
Potência Total / Puissance Total / Potência Total / Total Power	kW	8,2	8,2
Tensão / Tension / Tension / Tension	V	400	400

**Parede Dupla**  
Double Paroi  
Pared Doble  
Double Wall

MODELO / MODÈLE / MODELO / MODEL		LP1 S8 PLUS
CÓDIGO / CODE / CÓDIGO / CODE		2800.153
<b>Preço / Prix / Precio / Price</b>	<b>€</b>	<b>10.264,00</b>
Dimensões / Dimensions / Dimensiones	mm	690x800x1890/2275
Peso Líquido / Poids Net / Peso Neto / Net Weight	kg	155
Potência Total / Puissance Total / Potência Total / Total Power	kW	8
Tensão / Tension / Tension / Tension	V	400

\*Dispensador de Detergente / Distributeur de détergent / Dispensador de detergente / Detergent dispenser

**4 programas****Parede Dupla**  
Double Paroi  
Pared Doble  
Double Wall

MODELO / MODÈLE / MODELO / MODEL		LP3S PLUS
CÓDIGO / CODE / CÓDIGO / CODE		2800.156
<b>Preço / Prix / Precio / Price</b>	<b>€</b>	<b>15.038,00</b>
Dimensões / Dimensions / Dimensiones	mm	990X885X 1790/2050
Dimensões cesto / Dim. Panier/ Dim. Cesto / Basket dim	mm	850X725
Alt. Max. tabuleiros / Haut. Max. plateaux / Alt. Max. bandejas / Trays max. Height	mm	645
Cestos-hora / Paniers-heure / Cestos - hora / Racks-hour	nr (55°C)	20/10/6/5
Cons. Água p/ ciclos / Cons. D'eau p/ cycle / Cons. Agua p/ ciclo / Cycle water cons.	lt	4,3
Duração dos ciclos / Duration cycles / Duración ciclos / Cycles duration	min.	3(1)/ 6(2) /9 (3)/ 12(4)
Peso Líquido / Poids Net / Peso Neto / Net Weight	kg	221
Potência Total / Puissance Total / Potência Total / Total Power	kW	13,3
Tensão / Tension / Tension / Tension	V	400

**4 programas vapor****Parede Dupla**  
Double Paroi  
Pared Doble  
Double Wall

MODELO / MODÈLE / MODELO / MODEL		LP4S8 PLUS
CÓDIGO / CODE / CÓDIGO / CODE		2800.158
<b>Preço / Prix / Precio / Price</b>	<b>€</b>	<b>25.467,00</b>
Dimensões / Dimensions / Dimensiones	mm	1490X885X 1790/2310
Dimensões cesto / Dim. Panier/ Dim. Cesto / Basket dim	mm	1350X725
Alt. Max. tabuleiros / Haut. Max. plateaux / Alt. Max. bandejas / Trays max. Height	mm	820
Cestos-hora / Paniers-heure / Cestos - hora / Racks-hour	nr (55°C)	20/10/6/5
Cons. Água p/ ciclos / Cons. D'eau p/ cycle / Cons. Agua p/ ciclo / Cycle water cons.	lt	8,6
Duração dos ciclos / Duration cycles / Duración ciclos / Cycles duration	min.	3(1)/ 6(2) /9 (3)/ 12(4)
Peso Líquido / Poids Net / Peso Neto / Net Weight	kg	320
Potência Total / Puissance Total / Potência Total / Total Power	kW	14,8
Tensão / Tension / Tension / Tension	V	400

OPCIONAIS LAVAGEM / OPTIONNELLES LAVAGE / OPCIONALES LAVADO / WASHING OPTIONALS 42&gt;45

# GRANULES

Eletrónica - 10 Programas

**Remove as sujidades mais difíceis**  
**Enlève les saletés les plus difficiles**  
**Elimina la suciedad más difícil**  
**Removes the toughest dirt**

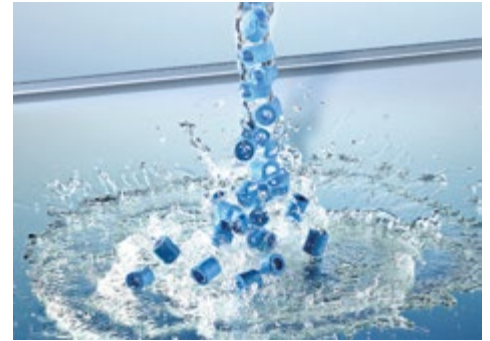

**Parede Dupla**  
 Double Paroi  
 Pared Doble  
 Double Wall

**0** Carros com rodas  
 Charriots avec roues  
 Carros con ruedas  
 Trolleys castors

**2800.162**

**1.981,00**



MODELO / MODÈLE / MODELO / MODEL CÓDIGO / CODE / CÓDIGO / CODE		900 PLUS 2800.160	900 TR PLUS 2800.161
<b>Preço / Prix / Precio / Price</b>	<b>€</b>	<b>31.566,00</b>	<b>35.467,00</b>
Dimensões / Dimensions / Dimensiones	mm	1095X910X1900/2020	1095X910X2100
Dimensões cesto / Dim. Panier/ Dim. Cesto / Basket dim	mm	735x240	735x240
Alt. Max. tabuleiros / Haut. Max. plateaux / Alt. Max. bandejas / Trays max. Height	mm	635	635
Cestos-hora / Paniers-heure / Cestos - hora / Racks-hour	nr(15°C)	15/10/7/6/5/4	12/8,5/6,5/5,5/4,5/3,5
Cons. Água ciclos / Cons. D'eau cycle / Cons. Agua ciclo / Cycle water cons.	lt	4,4	4,4
Duração dos ciclos (água-granul) / Duration cycles (eau-granul) / Duración ciclos (agua-granul) / Cycles duration (water-granul)	min	4 (1-2)/6 (3-4)/8 (5-6)/10 (7-8)/12 (9-10)/15 (11-12)	5 (1-2)/7 (3-4)/9 (5-6)/11 (7-8)/13 (9-10)/16 (11-12)
Peso Líquido /Poids Net /Peso Neto /Net Weight	kg	303	320
Potência Total / Puissance Total / Potência Total / Total Power	kW	13	13
Tensão / Tension / Tension / Tension	V	400	400



MODELO / MODÈLE / MODELO / MODEL CÓDIGO / CODE / CÓDIGO / CODE		1000 TR PLUS 2800.161A
<b>Preço / Prix / Precio / Price</b>	<b>€</b>	<b>45.468,00</b>
Dimensões / Dimensions / Dimensiones v	mm	1200x1110X2260/2305
Dimensões cesto / Dim. Panier/ Dim. Cesto / Basket dim	mm	850x350
Alt. Max. tabuleiros / Haut. Max. plateaux / Alt. Max. bandejas / Trays max. Height	mm	830
Cestos-hora / Paniers-heure / Cestos - hora / Racks-hour	nr(15°C)	12/8,5/6,5/5,5/4,5/3,5
Cons. Água p/ ciclos / Cons. D'eau p/ cycle / Cons. Agua p/ ciclo / Cycle water cons.	lt	5,5
Duração dos ciclos / Duration cycles / Duración ciclos / Cycles duration	min	5 (1-2)/7 (3-4)/9 (5-6)/11 (7-8)/13 (9-10)/16 (11-12)
Peso Líquido /Poids Net /Peso Neto /Net Weight	kg	350
Potência Total / Puissance Total / Potência Total / Total Power	kW	13
Tensão / Tension / Tension / Tension	V	400





DIHR

MÁQUINAS DE LAVAR UTENSÍLIOS-TABULEIROS COM GRANULOS

LAVE-OBJECTS À GRANULES

LAVA OBJECTOS A GRÁNULOS

GRANULES WAREWASHER



# GRANULES

Eletrónica - 10 Programas

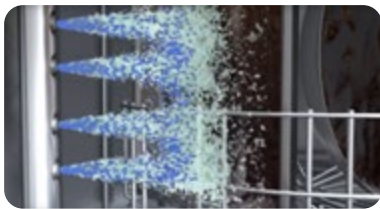

## 900 PLUS

6xGN 1/1 - 10xGN 1/1

GASTRONORM  
1/1

530x325

2xGN 2/1

GASTRONORM  
2/1

650x530

4xEN

EURONORM

600x400x20

4xEN

EURONORM

600x400x50

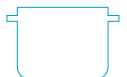

H = 635

## 1000 TR PLUS

8xGN 1/1

GASTRONORM  
1/1

530x325

4xGN 2/1

GASTRONORM  
2/1

650x530

3xEN

EURONORM

600x400x20

3x



800x600x50



H = 650

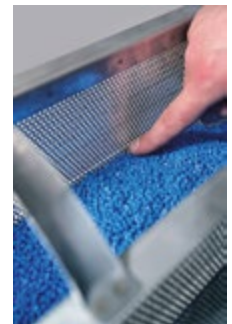

## ACESSÓRIOS STANDARD 900 PLUS



96101

2800.166

1.392,00



96135

2800.168

430,00



96136

2800.169

306,00



## ACESSÓRIOS STANDARD 1000 PLUS



96601

2800.165

1.641,00



96602

2800.163

226,00



96603

2800.163B

351,00



96604

2800.163A

385,00



## ACESSÓRIOS STANDARD 900/1000 PLUS



96102

2800.170

317,00

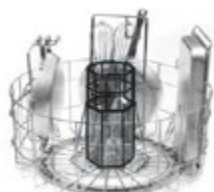

96103

2800.172

532,00



96104

2800.174

430,00



96105

2800.176

464,00



96100

2800.164

283,00



Trolley  
600x600x900



2800.162

1.981,00





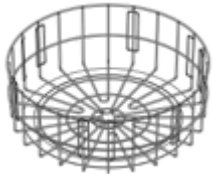
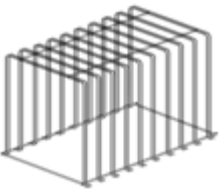
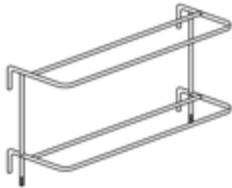

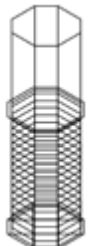
opcional  
opcional  
opcional  
optional

**GRÂNULOS 900-1000 / GRANULES 900-1000**  
**GRÂNULOS 900-1000 / GRANULES 900-1000**

	CÓD.	REF.	ACESSÓRIO / ACCESSOIRE / ACCESSORIO / ACCESSORIES	€
	2800.165	96601	CESTO REDONDO 96601 8XGN 1/1 OU 4XGN 2/1	<b>1.641,00</b>
	2800.166	96101	CESTO REDONDO 96101 6X1/1GN-2X2/1GN MOD.GRANULES	<b>1.392,00</b>
	2800.168	96135	SUPORTE 96135 10X1/1GN GASTRONORM MOD.GRANULES	<b>430,00</b>
	2800.169	96136	SUPORTE 96136 4 PEÇAS 600X400X20H MOD.GRANULES	<b>306,00</b>
	2800.163B	96603	SUPORTE 96603 3pcs 800x600x20 H	<b>351,00</b>
	2800.163	96602	SUPORTE 96602 GN 1/1- 2/3 - 1/2 - 1/3 MOD.GRANULES	<b>226,00</b>
	2800.163A	96604	SUPORTE 96604 GN 1/1- 2/3 MOD.GRANULES	<b>385,00</b>
	2800.170	96102	SUPORTE EM CONE 96102 MOD.GRANULES	<b>317,00</b>
	2800.172	96103	CESTO 96103 PORTA UTENSILIOS MOD.GRANULES	<b>532,00</b>

**GRÂNULOS 900-1000 / GRANULES 900-1000**  
**GRÁNULOS 900-1000 / GRANULES 900-1000**

	CÓD.	REF.	ACESSÓRIO / ACCESSOIRE / ACCESSORIO / ACCESSORIES	€
	2800.174	96104	SUPORTE 96104 PARA PANELAS PEQUENAS MOD. GRANULES Suporte para panelas pequenas Support pour petits pots Soporte para polias pequenas Support for small pots	<b>430,00</b>
	2800.176	96105	SUPORTE 96105 PARA PANELAS GRANDES MOD. GRANULES Suporte para panelas grandes Support pour grands pots Soporte para polias grandes Support for big pots	<b>464,00</b>
	2800.164	96100	BALDE DE 9 Kg GRANULADO 96100 MOD.GRANULES Granulado Balde Seau granulé Balde granule Granuls bucket	<b>283,00</b>
	2800.162		600x600x900mm (L.P.A.) Carros com rodas Charriots avec roues Carros con ruedas Trolleys castors	<b>1.981,00</b>





sob pedido  
sur demande  
a pedido  
on request

**Parede Dupla**  
Double Paroi  
Pared Doble  
Double Wall

## RX PRO

Cinco velocidades e enxaguamento duplo reforçado  
Cinq vitesses et double rinçage renforcé  
Cinco velocidades y enjuagado doble reforzado  
Five speeds and double reinforced rinse



## RX EVO

Dupla potência com enxaguamento prévio e final  
Double puissance avec rinçage préliminaire et final  
Doble potencia con enjuague previo y final  
Double power with preliminal and final rinse



## QX

Máquina de cinto com enxaguamento duplo reforçado  
Double ceinture de rinçage renforcée  
Máquina de cinturón con enjuagado doble reforzado  
Reinforced Double Rinse Belt Machine



## TX

Sistema de recuperação de calor e secagem a frio com turbo insuflante  
Système de refroidissement et de récupération de chaleur avec turbo-gonfleur  
Sistema de recuperación de calor y secado en frío con turbo insuflante  
Cooling and heat recovery system with turbo inflator





sob pedido  
sur demande  
a pedido  
on request

**Parede Dupla**  
Double Paroi  
Pared Doble  
Double Wall

VX



LX

Por correia, com enxaguamento duplo reforçado  
À la ceinture, avec double rinçage renforcé  
Por correa, con enjuagado doble reforzado  
By belt, with reinforced double rinse







MÁQUINAS DE LAVAR DE TÚNEL

MACHINES À LAVER CONVOY

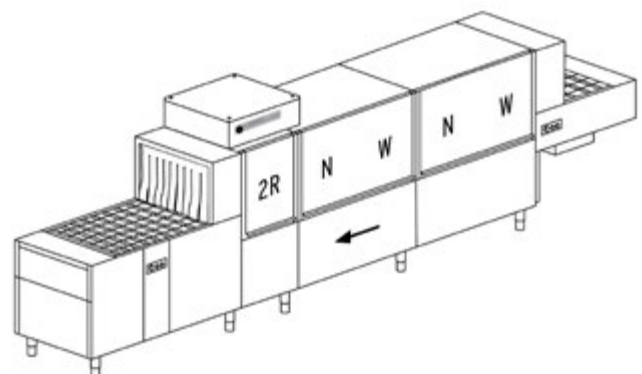
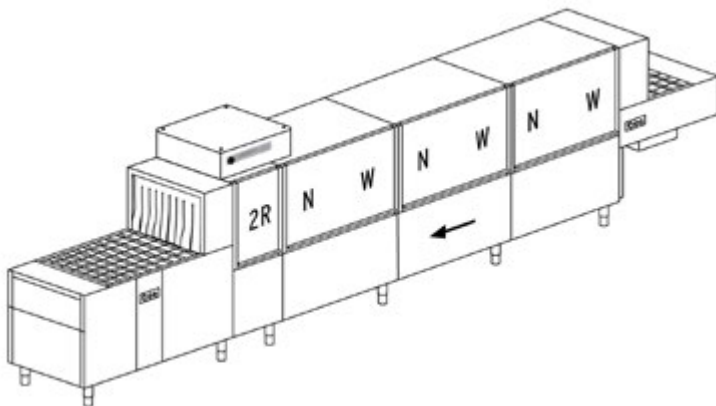
MÁQUINAS LAVAR DE TÚNEL

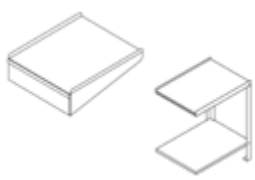
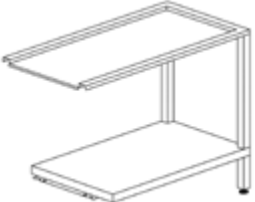



CONVEYOR WASHERS



	CÓD.	REF.	DIM.	€
 T 10 / T 28	2800.192	T10	600x510	<b>382,00</b>
	2800.194	T28	650x510x820	<b>471,00</b>
 T 34 A / T 34 B	2800.196	T 34 A	700x590x820	<b>586,00</b>
	2800.196 A	T 34 B	1200x590x820	<b>700,00</b>
 T 35	2800.198	T 35	1200x590x850	<b>1.057,00</b>
 A10	2800.202	A10	590x590x850	<b>1.337,00</b>
 TC16-M 16 TC24-M 24	2800.242	TC 16	1600X1000X850	<b>2.381,00</b>
	2800.244	M 16	1600X1000X850	<b>917,00</b>
	2800.246	TC 24	2400X1000X850	<b>3.348,00</b>
	2800.248	M 24	2400X1000X850	<b>1.248,00</b>
 RTC 18 - 24	2800.203	RTC 18	1800x1370x1550	<b>8.097,00</b>
	2800.203A	RTC 24	2400x1370x1550	<b>10.363,00</b>

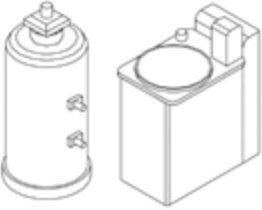

		CÓD.	REF.	DIM.	€
	Lavadouro P/ de Encastrar c/ Pio (500x400x300 H)	2800.204	A 20	1200x700x850 H	<b>2.011,00</b>
A20					
	Pio/Vasca/Sink (500x400x270 H)  P/ modelos <b>HT</b> - Versão direita / esquerda For <b>HT</b> models -right or left version	2800.206	T 50	1200x730x860 H	<b>1.489,00</b>
T50					
	Pio/Vasca/Sink (500x400x270 H)  P/ modelos <b>HT</b> Versão direita / esquerda For <b>HT</b> models -right or left version Anel borracha standard standard rubber ring	2800.208	T 50 F	1200x730x860H	<b>1.591,00</b>
T50F					
	Pio/Vasca/Sink (500x400x270 H)  P/ modelos <b>HT</b> - Versão direita/esquerda/ For <b>HT</b> models -right or left version / Anel borracha standard/ Standard rubber ring	2800.210	T 80 E	1500x730x850H	<b>2.088,00</b>
T80E					
	Pio/Vasca/Sink (500x400x270 H)  P/ modelos <b>HT-AX-RX</b> Versão direita/esquerda For <b>HT</b> models - right or left version	2800.212	T 55	1200x730x850 H	<b>1.922,00</b>
T55					
	Pio/Vasca/Sink (500x400x270 H)  P/ modelos <b>HT - AX - RX</b> Versão direita / es- querda For <b>HT</b> models - right or left version Anel borracha standard / Standard rubber ring	2800.214 2800.214A	T 80 T 90	1500x730x850H 1800x730x850 H	<b>2.266,00</b> <b>2.597,00</b>
T80/T90					

		CÓD.	REF.	DIM.	€
	Balde do Lixo Inox Standard	2800.220	P 01	Ø400x570H	<b>675,00</b>
	Com rodas / With wheels	2800.222	P 02		<b>827,00</b>
	Com rodas e pedal / With wheels and pedal	2800.224	P 03		<b>993,00</b>
	Depurador 12 LT ( Modelos <b>HT</b> e <b>LP</b> ) 12 Lt water softener	2800.226	D 1	Ø 200x500 H	<b>242,00</b>
	Depurador automático 12 LT ( Modelos <b>HT</b> e <b>LP</b> ) automatic water softener	2800.228	D 2	320x500x660	<b>1.439,00</b>
	Suporte Inox Stainless steel stand	2800.230	Para Modelos	500 H	<b>484,00</b>
		2800.232	GS 50		<b>484,00</b>
		2800.238	DS 50		<b>484,00</b>
	Mesa linear com rolos, completa com microswitch final Linear roller table with tank complete with end microswitch Só para modelos <b>AX-RX</b> / Only for <b>AX-RX</b> models Não acoplável / Not matched Não em curvas de 1800 / Not on 180° arcs	2800.258	LC 96/1	1100x650x860H	<b>1.540,00</b>
		2800.260	LC 96/1 A	1600x650x860H	<b>1.859,00</b>
	Só para Modelos <b>AX</b> : / Only for <b>AX - RX</b> models Mesa linear de rolos c/ rodas, completa com microswitch final / Linear roller table with tank and wheels complete with end microswitch Para ser acoplada só ao LC 97/3- LC 97/5 E LC 77/3 / To be connected only to LC 97/3- LC 97/5 and LC 77/3	2800.262	LC 96/2	1140x650x860 H	<b>2.381,00</b>
		2800.264	LC 96/2A	1640x650x860 H	<b>3.234,00</b>







**MODELOS AX/ MODÈLES AX / MODELOS AX / MODELS AX**

	<b>CÓD.</b>	<b>REF.</b>	<b>DIM.</b>	<b>€</b>
 <p>Curva de Rolo 90° Saída  <b>AX-RX</b>, só + LC 96/1 ou LC 96/1A / 90° roller arc with tank <b>AX-RX</b> exit, only + LC 96/1 or LC 96/1A</p>	2800.266	LC 97	1300x1300x860 H	<b>3.043,00</b>
 <p>Mesa de entrada ângulo completo com sistema / Angle loading table complete with basket pull-through system</p>	2800.272	LC 98	700x610x820 H	<b>1.566,00</b>
 <p>Curva mecanizada 90° ( horária / anti horaria) / 90° mechanized arc (dockWise/anti-dockWise) P /AX</p>	2800.267	LC 77/2	850x850x885H	<b>3.985,00</b>
 <p>Curva mecanizada 180° ( horária / anti horaria) /180° mechanized arc (dockWise/anti-dockWise)</p>	2800.269	LC 77/3	850x1500x885 H	<b>5.360,00</b>
 <p>Curva motorizada 90° (horária / anti horaria) / 90° motorized chain conveyor (dockWise/anti-dockWise) Saída somente LC 96/1 - LC 96/1 A / Exit only LC 96/1 - LC 96/1 A Não aconselhável se a máquina estiver equipada com regulador de velocidade/ Not suggested if the machine is equipped with speed adjuster</p>	2800.268	LC 97/2	850x850x885 H	<b>7.333,00</b>
 <p>Curva motorizada 180° (horária / anti horaria) / motorized chain conveyor (dockWise/anti-dockWise) <b>AX 161 e AX 290</b>, adaptador extra sem custos / <b>AX 161 and AX 290</b> extra adaptor (free of charge) Não aconselhável se a máquina estiver equipada com regulador de velocidade / Not suggested if the machine is equipped with speed adjuster</p>	2800.270	LC 97/3	850x1500x885 H	<b>9.713,00</b>

		<b>CÓD.</b>	<b>REF.</b>	<b>DIM.</b>	<b>€</b>
	Cesto redondo copos / Round Basket for glasses	2800.284	C 21	Ø 350x105h	<b>74,00</b>
	Cesto redondo copos / Round Basket for glasses	2800.286	C 07	Ø 370x120h	<b>79,00</b>
	Cesto redondo copos / Round Basket for glasses	2800.288	C 16	Ø 400x145h	<b>79,00</b>
	Cesto Pratos Arame / Plates basket				
	10 pratos / plates	2800.296	C 03	370x370x100h	<b>68,00</b>
	12 pratos / plates	2800.299	-	400x400x110h	<b>26,00</b>
	14 pratos / plates	2800.302	-	450x450x106h	<b>28,00</b>
	Cesto Copos	2800.273	-	350x350x150h	<b>18,00</b>
		2800.278	-	400x400x150h	<b>21,00</b>
	Cesto Copos Arame	2800.277	-	370x370x140h	<b>65,00</b>
	Cesto Copos Plástico	2800.281	-	450x450x106h	<b>26,00</b>
	Cesto copos inclinado Sloped glass basket	2800.305	C 123	400x400x210h	<b>96,00</b>

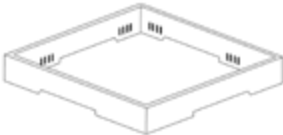



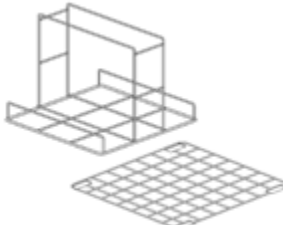

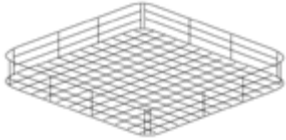
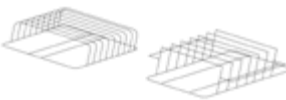

		<b>CÓD.</b>	<b>REF.</b>	<b>DIM.</b>	<b>€</b>
	Suporte pires / Saucer holder	2800.309	-	290x90x75	<b>4,95</b>
	Cesto talheres Cutlery basket	2800.311	-	Ø125x110	<b>3,00</b>
	Cesto talheres quadrado Square Cutlery basket	2800.311A	-	Ø125x110	<b>2,00</b>
	Cesto pratos Plate basket 18 Pratos / Plates	2800.313	-	500x500x105	<b>27,00</b>
	Cesto malha larga p/ copos Large mesh basket	2800.321	-	500x500x105	<b>27,00</b>
	Cesto GASTRONORM GASTRONORM tray basket P/ Modelos: TEKNO; HT; AX; ÓPTIMA	2800.316	C43/B	500x500x105h	<b>164,00</b>

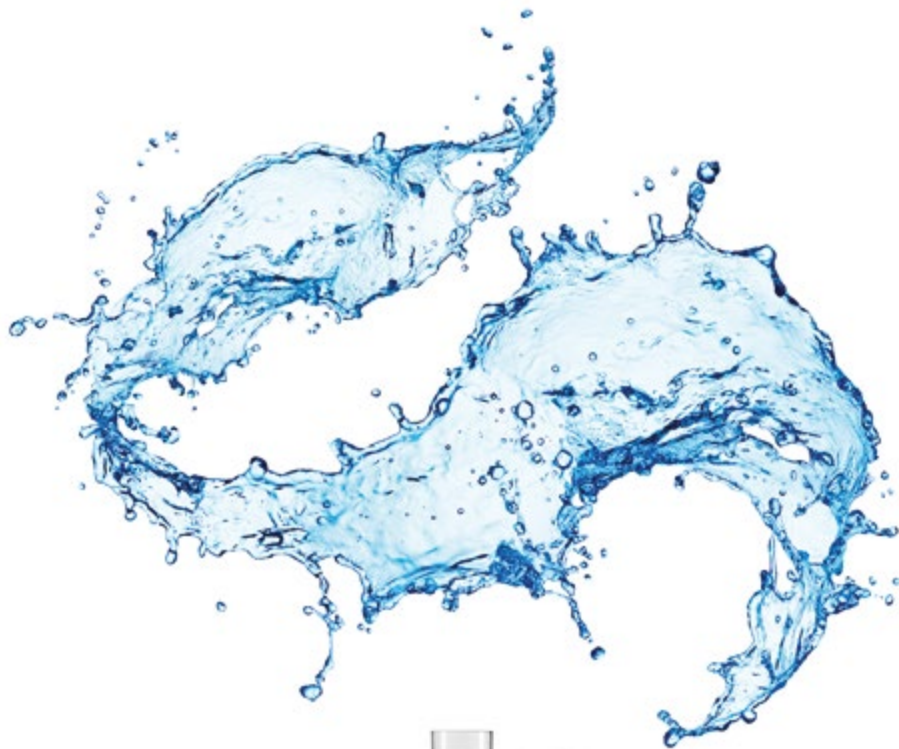
		<b>CÓD.</b>	<b>REF.</b>	<b>DIM.</b>	<b>€</b>
	Aumento p/ cesto de copos / For glass support C112; C113; C114	2800.322	C111	500x500x50	<b>57,00</b>
	Suporte para aumento de copos / Holder for glass support - C 111 5x5 - Copos/ Glasses Diâmetro copo / Glass Ø: 87 mm	2800.324	C112	500x500x50	<b>57,00</b>
	Suporte para aumento de copos / Holder for glass support - C 111 4x4 - Copos/ Glasses Diâmetro copo / Glass Ø:110 mm	2800.326	C 113	500x500x50	<b>57,00</b>
	Suporte para aumento de copos / Holder for glass support - C 111 6x6 - Copos/ Glasses Diâmetro copo / Glass Ø: 72 mm	2800.328	C 114	500x500x50	<b>57,00</b>
	Cesto Talheres p/AX; FX; OPTIMA 500 CUTLERY AX, FX and CUTLERY 500 models	2800.331	-	490x180x140	<b>35,00</b>
	Grelha / Grid LP1 800 - LP1 S 8	2800.332	C100	550x550	<b>170,00</b>



	CÓD.	REF.	DIM.	€
 <p>Cesto aço inox / Stainless steel basket LP1 800 - LP1 S8</p>	2800.336	C87/B	550x665x75 H	<b>260,00</b>
 <p>Suporte tabuleiros / Tray supports G600-LP1 S5</p>	2800.344	575005	500x500x160 6 pcs	<b>209,00</b>
<p>H 600</p>	2800.346	11600054	500x605x160 6 pcs	<b>306,00</b>



		CÓD.	REF.	€
	Misturadora bancada com duche Mixer de plain de travail avec robinet Mezclador sobremesa con grifo Top range mixer with tap	2025.028	V -1583	<b>340,00</b>
	Misturadora de bancada monofuro com duche Mélangeur monotrou de comptoir avec bec et douche Mezclador monomando de encimera con caño y ducha Countertop Single Hole Mixer with Spout and Shower	UDI105021006		<b>291,00</b>
	Torneira de Coluna Robinet de colonne Grifo de Columna Column faucet	UDI120021126		<b>470,00</b>
	Enrolador de Parede 12m com Chuveiro Enrouleur mural 12m avec douche Enrollador de pared de 12 m con ducha 12m Wall Winder with Shower	UDI635061011		<b>983,00</b>
	Chuveiro Externo de Lavagem Douche de lavage externe Ducha de lavado externa External Washing Shower	UDI635061060		<b>159,00</b>



# INFO

## CESTOS - SUPORTES EM DOTAÇÃO - LAVAGEM

PANIER - SUPPPORTSTANDARD - LAVAGE

STANDARD CESTAS - SOPORTES - LAVAJE

STANDARD BASKETS HOLDERS - WASHING



### MÁQUINAS DE LAVAR COPOS

2 x Cestos de copos, 1 x Suporte de pratos, 1 x Porta-talheres

#### MÁQUINAS DE LAVAR LOUÇA

1 x Cesto de pratos, 1 x Cesto de Copos, 1 x Porta-talheres

#### MÁQUINAS DE LAVAR TALHERES (OPTIMA CUTLERY)

1 x Cesto de malha grande C44, 2 x Porta-talheres C47

#### MÁQUINAS DE LAVAR LOUÇA COM CAPOTA

2 x Cesto de pratos, 1 Cesto de copos, 1 x Porta-talheres

#### MÁQUINAS DE LAVAR LOUÇA COM TAPETE

1 x Cesto de pratos, 1 x Cesto de copos, 1 x Porta-talheres 8 peças, 1 x Cesto de Tabuleiros

#### MÁQUINAS DE LAVAR UTENSÍLIOS

G 600 - H 600:1 x S/S Suporte de tabuleiros, 1 x Cesto de malha grande plástico, 1 x Porta-espátulas S/S, LP1/S5:1 x cesto S/S, 1 x Suporte de tabuleiros, 1 x Porta-espátulas S/S,

LP1/800 - LP1/S8:1 x Cesto S/S, 1 x S/S Grelha, 1 x Suporte de tabuleiros, 1 x Porta-espátulas S/S,

LP2 / S - LP3 / S - LP4/S8:1 x Cesto S/S, 1 x Suporte de tabuleiros, 1 x Porta-espátulas S/S

### LAVE - VERRES

2 x Panier à verres, 1 x Support petites assiettes, 1 x Panier à couverts

#### LAVE - ASSIETTES

1 x Panier à assiettes, 1 x Panier à verres, 1 x Panier à couverts

#### LAVE COUVERTS

1 x C44 Panier maille large, 2 x C47 Panier à couverts

#### LAVEVAISSELLES A CAPOT

2 x Panier à assiettes, 1 x Panier à verres, 1 x Panier à couverts

#### LAVE - VAISSELLE A PANIER A TRACTION

1 x Panier à assiettes, 1 x Panier à verres, 1 x Panier à couverts 8 places, 1 x Panier pour plateaux

#### LAVE - OBJETS

G 600 - H 600:1 x Support plateaux inox, 1 x Panier plastique maille large, 1 x Panier inox porte-spatules, LP1/S5:1 x Panier inox, 1 x Support plateaux, 1 x Panier inox porte-spatules,

LP1/800 - LP1/S8:1 x Panier inox, 1 x Grille inox, 1 x Support plateaux, 1 x Panier inox porte-spatules, LP2/S - LP3/S - LP4/S8:1 x Panier inox, 1 x Support plateaux inox, 1 x Panier inox porte-spatules

### LAVAVAJILLAS

2 x Cesta vasos, 1 x Soporte platillos, 1 x Cestillo cubiertos

#### LAVA PLATOS

1 x Cesta platos, 1 x Cesta vasos, 1 x Cestillo cubiertos

#### LAVACUBIERTOS

1 x C44 Cesta universal, 2 x C47 Cestillo cubiertos

#### LAVAVAJILLAS DE TAPA

2 x Cesta platos, 1 x Cesta vasos, 1 x Cesta cubiertos

#### LAVAVAJILLAS DE CESTO ARRASTRADO

1 x Cesta platos, 1 x Cesta vasos, 1 x Cesta cubiertos para 8 piezas, 1 x Cesta bandejas

#### LAVA OBJETOS

G 600 - H 600:1 x Soporte bandejas de acero inoxidable, 1 x Cesta de plástico orificios grandes,

1 x Cesta portaespátulas de acero inoxidable,

LP1/S5:1 x Cesta de acero inoxidable, 1 x Soporte bandejas, 1 x Cesta portaespátulas de acero inoxidable,

LP1/800 - LP1/S8:1 x Cesta de acero inoxidable, 1 x Parrilla de acero inoxidable, 1 x Soporte bandejas,

1 x Cesta portaespátulas de acero inoxidable,

LP2/S - LP3/S - LP4/S8:1 x Cesta de acero inoxidable, 1 x Soporte bandejas de acero inoxidable, 1 x Cesta portaespátulas de acero inoxidable

### GLASSWASHERS

2 x Glass basket, 1 x Saucer holder, 1 x Cutlery holder

#### DISHWASHERS

1 x Dish basket, 1 x Glass basket, 1 x Cutlery holder

#### CUTLERY WASHER

1 x C44 large mesh basket, 2 x C47 Cutlery holder

#### HOOD-TYPE DISHWASHERS

2 x Dish basket, 1 x Glass basket, 1 x Cutlery holder

#### RACK CONVEYOR DISHWASHERS

1 x Dish basket, 1 x Glass basket, 1 x Cutlery basket 8 places, 1 x Tray basket

#### WAREWASHERS

G 600 - H 600:1 x S/S trays support, 1 x Large mesh plastic basket 1 x S/S spatula holder, LP1/S5:1 x S/S basket, 1 x trays support, 1 x S/S spatula holder,

LP1/800 - LP1/S8:1 x S/S basket, 1 x S/S griddle, 1 x trays support, 1 x S/S spatula holder, LP2/S - LP3/S - LP4/S8:1 x S/S basket, 1 x S/S trays support, 1 x S/S spatula holder



## AQUA

Silenciosa + Económica  
 Silencieux + Economique  
 Silencioso + Económica  
 Silent + Economical

LS : Lavagem Superior / Lavage Supérieur / Lavage Superior / Upper washing



MODELO / MODÈLE / MODELO / MODEL CÓDIGO / CODE / CÓDIGO / CODE		AQUA 35 3000.002	AQUA 37 3000.004
<b>Preço / Prix / Precio / Price</b>	€	<b>1.281,00</b>	<b>1.852,00</b>
Dimensões / Dimensions / Dimensiones	mm	400x495x595	420x490x665
Cestos-hora / Paniers-heure / Cestos - hora / Racks-hour	nr (55°C)	30	30
Dimensões cesto / Dim. Panier/ Dim. Cesto / Basket dim	mm	350x350	370x370
Alt. Max. Copos / Haut. Max. Verres / Alt. Max. Vajillas / Max. Height Glass	mm	195	275
Duração dos ciclos / Duration cycles / Duración ciclos / Cycles duration	seg	120(1)	120(1)
Peso Líquido / Poids Net / Peso Neto / Net Weight	kg	28	30
Potência Total / Puissance Total / Potência Total / Total Power	kW	2,6	3
Cons. Água p/ ciclos / Cons. D'eau p/ cycle / Cons. Agua p/ ciclo / Cycle water cons.	lt	1,4	1,8
Tensão / Tension / Tension / Tension	V	230	230



MODELO / MODÈLE / MODELO / MODEL CÓDIGO / CODE / CÓDIGO / CODE		AQUA 40 3000.008	AQUA 40 LS 3000.010
<b>Preço / Prix / Precio / Price</b>	€	<b>1.857,00</b>	<b>2.049,00</b>
Dimensões / Dimensions / Dimensiones	mm	450x535x710	450x535x710
Cestos-hora / Paniers-heure / Cestos - hora / Racks-hour	nr (55°C)	30	30
Dimensões cesto / Dim. Panier/ Dim. Cesto / Basket dim	mm	400x400	400x400
Alt. Max. Copos / Haut. Max. Verres / Alt. Max. Vajillas / Max. Height Glass	mm	305	305
Alt. Max. Pratos / Haut. Max. Aissietes / Alt. Max. Platos / Max. Height Dishes	mm diam.	-	295
Duração dos ciclos / Duration cycles / Duración ciclos / Cycles duration	seg	120(1)	120(1)
Peso Líquido / Poids Net / Peso Neto / Net Weight	kg	37	37
Potência Total / Puissance Total / Potência Total / Total Power	kW	3,2	3,2
Cons. Água p/ ciclos / Cons. D'eau p/ cycle / Cons. Agua p/ ciclo / Cycle water cons.	lt	1,8	2,3
Tensão / Tension / Tension / Tension	V	230	230



MODELO / MODÈLE / MODELO / MODEL CÓDIGO / CODE / CÓDIGO / CODE		AQUA 50 MONO 3000.012	AQUA 50 3000.014
<b>Preço / Prix / Precio / Price</b>	€	<b>2.441,00</b>	<b>2.477,00</b>
Dimensões / Dimensions / Dimensiones	mm	590x600x850	590x600x850
Cestos-hora / Paniers-heure / Cestos - hora / Racks-hour	nr (55°C)	30	30/20
Dimensões cesto / Dim. Panier/ Dim. Cesto / Basket dim	mm	500x500	500x500
Alt. Max. Copos / Haut. Max. Verres / Alt. Max. Vajillas / Max. Height Glass	mm	320	320
Alt. Max. Pratos / Haut. Max. Aissietes / Alt. Max. Platos / Max. Height Dishes	mm diam.	345	345
Duração dos ciclos / Duration cycles / Duración ciclos / Cycles duration	seg	120(1)	120(1)/ 180(2)
Peso Líquido / Poids Net / Peso Neto / Net Weight	kg	57	57
Potência Total / Puissance Total / Potência Total / Total Power	kW	3,5	5,2
Cons. Água p/ ciclos / Cons. D'eau p/ cycle / Cons. Agua p/ ciclo / Cycle water cons.	lt	2,3	2,3
Tensão / Tension / Tension / Tension	V	230	400

seg. - segundos / secondes / segundos / seconds



**KROMO****MÁQUINAS DE LAVAR DE CAPOTA - HOOD**

LAVE-VAISSELLE - HOOD

LAVAVAJILLAS Y PLATOS - HOOD

GLASS &amp; DISHWASHERS - HOOD

**HOOD****INOX**

Braços lavagem em inox

Inoxydable bras de lavage en acier

Brazos de acero inoxidable de lavado

Stainless steel washing arms

MODELO / MODÈLE / MODELO / MODEL		HOOD 110
CÓDIGO / CODE / CÓDIGO / CODE		3000.056
<b>Preço / Prix / Precio / Price</b>	<b>€</b>	<b>4.212,00</b>
Dimensões / Dimensions / Dimensiones	mm	650(720)X735X 1470/1890
Cestos-hora / Paniers-heure / Cestos - hora / Racks-hour	nr	60
Dimensões cesto / Dim. Panier/ Dim. Cesto / Basket dim	mm	500x500
Potência Total / Puissance Total / Potência Total / Total Power	kW	10,2
Bomba de lavagem / Pompe de lavage / Bomba de lavado / Washing Pump	W	1120
Capacidade da cuba /Capacité da cuve/ capacidad de la cuba/ Tank capacity	lt	30
Capacidade da caldeira / Cap. surchauffeur / Cap. caldera / Boiler Capacity	lt	10
Cons. Água p/ ciclos / Cons. D'eau p/ cycle / Cons. Agua p/ ciclo / Cycle water cons.	lt	2,8
Tensão / Tension / Tension / Tension	V	400



600x400

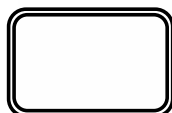

MODELO / MODÈLE / MODELO / MODEL	LUX 71-EL PLUS	
CÓDIGO / CODE / CÓDIGO / CODE	3000.052	
<b>Preço / Prix / Precio / Price</b>	€	<b>3.849,00</b>
Dimensões / Dimensions / Dimensiones	mm	600x610x850
Potência Total / Puissance Total / Potência Total / Total Power	kW	5,5
Peso Líquido / Poids Net / Peso Neto / Net Weight	kg	70
Tensão / Tension / Tension / Tension	V	400



confirmar disponibilidade  
confirmer la disponibilité  
confirmar la disponibilidad  
confirm the availability





## MÁQUINAS DE LAVAR - PAREDE SIMPLIS - DWASH

LAVE-VAISSELLE - DWASH  
LAVAVAJILLAS Y PLATOS - DWASH  
GLASS & DISHWASHERS - DWASH



 Estrutura em aço inox AISI 304  
Porta com parede dupla  
Cuba inclinada com suportes  
aparafusados  
Braços de lavagem e enxaguamento  
em polipropileno  
Filtro de bomba de lavagem  
Bomba de abrillantador e termostop  
incluídos.

 Structure en acier inoxydable AISI 304  
Porte à double paroi  
Cuba inclinée avec des soutiens  
autonomes  
Bras de lavage et de rinçage en  
polypropylène  
Filtre de pompe de lavage  
Pompe de liquide de rinçage et  
thermostat inclus

 Estructura de acero inoxidable AISI  
304  
Puerta con doble pared  
Cuba inclinada con soportes  
aparafusados  
Brazos de lavado y enjuagado en  
polipropileno  
Filtro de bomba de lavado  
Bomba de abrillantador y termostop  
incluidos

 Structure in stainless steel AISI 304  
Door with double wall  
Tilted Cuba with self-supporting  
supports  
Polypropylene wash and rinse arms  
Wash pump filter  
Rinse aid pump and thermostat  
included

MODELO / MODÈLE / MODELO / MODEL	BOMBA DE DRENAGEM POMPE DE VIDANGE BOMBA DE DRENAJE DRAIN PUMP
CÓDIGO / CODE / CÓDIGO / CODE	3000.220
Preço / Prix / Precio / Price	€ 354,00

MODELO / MODÈLE / MODELO / MODEL	DOSEADOR DETERGENTE DISTRIBUTEUR DE DÉTERGENT DISPENSADOR DE ETERGENTE DETERGENT DISPENSER
CÓDIGO / CODE / CÓDIGO / CODE	3000.222
Preço / Prix / Precio / Price	€ 298,00





MODELO / MODÈLE / MODELO / MODEL	DWASH 35	
CÓDIGO / CODE / CÓDIGO / CODE	3000.202	
Preço / Prix / Precio / Price	€ 1.274,00	
Dimensões / Dimensions	mm	400x495x585
Dimensões cesto / Dim. Panier/ Dim. Cesto / Basket dim	mm	350x350
Alt. Max. Copos / Haut. Max. Verres / Alt. Max. Vajillas / Max. Height Glass	mm	195
Alt. Max. Pratos / Haut. Max. Aissietes / Alt. Max. Platos / Max. Height Dishes	mm diam.	-
Cestos por ciclo / Paniers par cycle / Cestas por ciclo / Racks per cycle	nr /h 55°C (sec.)	30
Cons. Água p/ ciclos / Cons. D'eau p/ cycle / Cons. Agua p/ ciclo / Cycle water cons.	lt	1,4
Duração dos ciclos / Duration cycles / Duración ciclos / Cycles duration	seg	120(1)
Peso Líquido / Poids Net /Peso Neto /Net Weight	kg	28
Potência Total / Puissance Total /Potência Total / Total Power	kW	2,6
Tensão / Tension / Tension / Tension	V	230





MODELO / MODÈLE / MODELO / MODEL	DWASH 40	DWASH 40 LS
CÓDIGO / CODE / CÓDIGO / CODE	3000.204	3000.206
Preço / Prix / Precio / Price	€ 1.841,00	1.925,00
Dimensões / Dimensions	mm	450x535x700
Dimensões cesto / Dim. Panier/ Dim. Cesto / Basket dim	mm	400x400
Alt. Max. Copos / Haut. Max. Verres / Alt. Max. Vajillas / Max. Height Glass	mm	305
Alt. Max. Pratos / Haut. Max. Aissietes / Alt. Max. Platos / Max. Height Dishes	mm diam.	-
Cestos por ciclo / Paniers par cycle / Cestas por ciclo / Racks per cycle	nr /h 55°C (sec.)	30
Cons. Água p/ ciclos / Cons. D'eau p/ cycle / Cons. Agua p/ ciclo / Cycle water cons.	lt	1,8
Duração dos ciclos / Duration cycles / Duración ciclos / Cycles duration	seg	120(1)
Peso Líquido / Poids Net /Peso Neto /Net Weight	kg	37
Potência Total / Puissance Total /Potência Total / Total Power	kW	3,2
Tensão / Tension / Tension / Tension	V	230

seg - segundos / secondes / segundos / seconds

 Estrutura em aço inox AISI 304  
 Porta com parede dupla  
 Cuba inclinada com suportes  
 aparafusados  
 Braços de lavagem e enxaguamento  
 em polipropileno  
 Filtro de bomba de lavagem  
 Bomba de brilhantador e termostop  
 incluídos.

 Structure en acier inoxydable AISI 304  
 Porte à double paroi  
 Cuba incliné avec des soutiens  
 autonomes  
 Bras de lavage et de rinçage en  
 polypropylène  
 Filtre de pompe de lavage  
 Pompe de liquide de rinçage et  
 thermostat inclus

 Estructura de acero inoxidable AISI  
 304  
 Puerta con doble pared  
 Cuba inclinada con soportes  
 apartafusados  
 Brazos de lavado y enjuagado en  
 polipropileno  
 Filtro de bomba de lavado  
 Bomba de abrillantador y termostop  
 incluidos

 Structure in stainless steel AISI 304  
 Door with double wall  
 Tilted Cuba with self-supporting  
 supports  
 Polypropylene wash and rinse arms  
 Wash pump filter  
 Rinse aid pump and thermostat  
 included



MODELO / MODÈLE / MODELO / MODEL		DWASH 50 T	DWASH 50T 400V*
CÓDIGO / CODE / CÓDIGO / CODE		3000.212	3000.213
<b>Preço / Prix / Precio / Price</b>	<b>€</b>	<b>2.170,00</b>	<b>2.224,00</b>
Dimensões / Dimensions / Dimensiones	mm	590x600x850	590x600x850
Cestos por ciclo / Paniers par cycle / Cestas por ciclo / Racks per cycle	nr /h 55°C (sec.)	46(90) 30(120) 20(180)	46(90) 30(120) 20(180)
Cestos por ciclo / Paniers par cycle / Cestas por ciclo / Racks per cycle	nr /h 10°C (sec.)	(90) (120) (180)	(90) (120) (180)
Dimensões cesto / Dim. Panier/ Dim. Cesto / Basket dim	mm	500x500	500x500
Diam. Pratos / Diam. Aissietes / Diam. Platos / Diam. Dishes	mm diam.	345	345
Alt. Max. Copos / Haut. Max. Verres / Alt. Max. Vajillas / Max. Height Glass	mm	320	320
Cons. Água p/ ciclos / Cons. D'eau p/ cycle / Cons. Agua p/ ciclo / Cycle water cons.	lt	29	29
Duração dos ciclos / Duration cycles / Duración ciclos / Cycles duration	seg	90-120-180	90-120-180
Peso Líquido / Poids Net / Peso Neto / Net Weight	kg	56,5	56,5
Potência Total / Puissance Total / Potência Total / Total Power	kW	3,2	4,6
Tensão / Tension / Tension / Tension	V	230	400

Inclui 3 cestos (1 copos + 1 pratos + 1 talheres) | Comprend 3 paniers (1 verres + 1 assiettes + 1 coutellerie)  
 Incluye 3 cestas (1 vasos + 1 platos + 1 cubiertos) | Includes 3 baskets (1 cups + 1 plates + 1 cutlery)

seg - segundos / secondes / segundos / seconds



**confirmar disponibilidade**  
 confirmer la disponibilité  
 confirmar la disponibilidad  
 confirm the availability



## MÁQUINAS DE LAVAR - PAREDE SIMPLES - DWASH

LAVE-VAISSELLE - DWASH  
LAVAVAJILLAS Y PLATOS - DWASH  
GLASS & DISHWASHERS - DWASH



Cúpula em aço inox AISI 304  
Parede simples  
Filtros a cobrir a totalidade da cuba  
Filtro de bomba de lavagem  
Braços de lavagem e enxaguamento em polipropileno  
Dosificador de abrillantador e termostop incluídos  
Start/stop com fecho/abertura da cúpula



Dôme en acier inoxydable AISI 304,  
Pari simple  
Filtres pour couvrir la totalité du réservoir  
Filtre de pompe de lavage  
Bras de lavage et de rinçage en polypropylène  
Distributeur de thermodurcis et thermodurcis inclus  
Démarrage / arrêt avec fermeture / ouverture du dôme



Cúpula de acero inoxidable AISI 304,  
Pared simple  
Filtros a cubrir la totalidad de la cuba  
Filtro de bomba de lavado  
Brazos de lavado y enjuagado en polipropileno  
Dosificador de abrillantador y termostop incluidos  
Start / stop con cierre / apertura de la cúpula



Dome in stainless steel AISI 304,  
Single wall  
Filters to cover the entire tank  
Wash pump filter  
Polypropylene wash and rinse arms  
Thermoset and thermostet dispenser included  
Start / stop with closing / opening of the dome



Novo painel de controlo eletrónico para os modelos T  
Nouveau panneau de contrôle électronique pour les modèles T  
Nuevo panel de control electrónico para los modelos T  
New electronic control panel for T models



MODELO / MODÈLE / MODELO / MODEL CÓDIGO / CODE / CÓDIGO / CODE		DWASH 100 T 3000.216
<b>Preço / Prix / Precio / Price</b>	<b>€</b>	<b>3.707,00</b>
Dimensões / Dimensions / Dimensiones	mm	720x735x1445 / 1880
Dimensões cesto / Dim. Panier/ Dim. Cesto / Basket dim	mm	500x500
Cestos por ciclo / Paniers par cycle / Cestas por ciclo / Racks per cycle	nr /h 55°C (sec.)	46(50) 30(120) 20(180)
Cestos por ciclo / Paniers par cycle / Cestas por ciclo / Racks per cycle	nr /h 10°C (sec.)	(50) (120) (180)
Diâmetro Pratos / Diamètre Aissietes / Diametro Platos / Dishes Diameter	mm diam.	410
Dimensão Máxima Tabuleiro / Dimmension Maximale Plateau / Dimension Máxima Bandeja / Trays Maximum Dimension	mm	GN 1/1 (530X325)
Capacidade Cuba / Capacité Cuve / Capacidad Cuba / Tank Capacity	mm	30
Dimensão Máxima Tabuleiro / Dimmension Maximale Plateau / Dimension Máxima Bandeja / Trays Maximum Dimension	mm	5,7
Cons. Água p/ ciclos / Cons. D'eau p/ cycle / Cons. Agua p/ ciclo / Cycle water cons.	lt	2,8
Duração dos ciclos / Duration cycles / Duración ciclos / Cycles duration	seg	50-120-180
Peso Líquido /Poids Net /Peso Neto /Net Weight	kg	100
Potência Total / Puissance Total /Potência Total / Total Power	kW	6,55
Tensão / Tension / Tension / Tension	V	400

Inclui 3 cestos (1 copos + 1 pratos + 1 talheres) | Comprend 3 paniers (1 verres + 1 assiettes + 1 coutellerie)  
Incluye 3 cestas (1 vasos + 1 platos + 1 cubiertos) | Includes 3 baskets (1 cups + 1 plates + 1 cutlery)

seg - segundos / secondes / segundos / seconds



Estrutura em aço inox; lâmpada ultravioleta;



Structure en acier inox ; avec lampe ultraviolet;



Estructura en acero inoxidable; lámpara ultravioleta



Structure in stainless steel; ultraviolet lamp



MODELO / MODÈLE / MODELO / MODEL		UDMPT01
CÓDIGO / CODE / CÓDIGO / CODE		5200.110
<b>Preço / Prix / Precio / Price</b>	€	<b>3.254,00</b>
Dimensões / Dimensions / Dimensiones	mm	560x550x410
Capacidade / Capacité / Capacidad / Capacity	kg	3
Peças / Pièces / Pieças / Pieces	h	3000
Potência Lâmpada/Puissance lampe/Potencia lámpara/Lamp Power	W	8
Potência Total / Puissance Total /Potência Total / Total Power	kW	0,6
Peso Bruto / Poids Brut / Peso Bruto / Gross Weight	kg	50
Tensão / Tension / Tension / Tension	V	230



MODELO / MODÈLE / MODELO / MODEL		UDMPT02
CÓDIGO / CODE / CÓDIGO / CODE		5200.115
<b>Preço / Prix / Precio / Price</b>	€	<b>4.220,00</b>
Dimensões / Dimensions / Dimensiones	mm	660x650x700
Capacidade / Capacité / Capacidad / Capacity	kg	5
Peças / Pièces / Pieças / Pieces	h	7000
Potência Lâmpada/Puissance lampe/Potencia lámpara/Lamp Power	W	8
Potência Total / Puissance Total /Potência Total / Total Power	kW	0,8
Peso Bruto / Poids Brut / Peso Bruto / Gross Weight	kg	82
Tensão / Tension / Tension / Tension	V	230

Granulado para máquina de polir talheres  
 Granulés pour machine à polir les couverts  
 Granulos para máquina pulidora de cubiertos  
 Granules for cutlery polishing machine

5200.116

24,77





UDI

**POLIDORES DE TALHERES**  
POLISSEURS DE COUVERTS  
PULIDORAS DE CUBIERTOS  
CUTLERY POLISHERS



MODELO / MODÈLE / MODELO / MODEL CÓDIGO / CODE / CÓDIGO / CODE		UDMPT01 5900.330
<b>Preço / Prix / Precio / Price</b>	€	<b>3.098,00</b>
Dimensões / Dimensions / Dimensiones	mm	560x550x410
Capacidade / Capacité / Capacidad / Capacity	kg	3
Peças / Pièces / Pieças / Pieces	h	3000
Potência Lâmpada/Puissance Lampe/Potencia lámpara/Lamp Power	W	8
Potência Total / Puissance Total /Potência Total / Total Power	kW	0,6
Peso Bruto / Poids Brut / Peso Bruto / Gross Weight	kg	50
Tensão / Tension / Tension / Tension	V	230



MODELO / MODÈLE / MODELO / MODEL CÓDIGO / CODE / CÓDIGO / CODE		UDMPT02 5900.332
<b>Preço / Prix / Precio / Price</b>	€	<b>4.895,00</b>
Dimensões / Dimensions / Dimensiones	mm	560x550x410
Peças / Pièces / Pieças / Pieces	h	7000
Potência Total / Puissance Total /Potência Total / Total Power	kW	0,9
Peso Bruto / Poids Brut / Peso Bruto / Gross Weight	kg	60
Tensão / Tension / Tension / Tension	V	230





MODELO / MODÈLE / MODELO / MODEL CÓDIGO / CODE / CÓDIGO / CODE		POSALINDO 2088.150
<b>Preço / Prix / Precio / Price</b>	€	<b>3762,00</b>
Dimensões / Dimensions / Dimensiones	mm	500x495x445
Peças / Pièces / Pieças / Pieces	2 min	50
Peças Prata / Pièces Argent / Pieças Plata / Silver Pieces	5 min	50
Potência Total / Puissance Total /Potência Total / Total Power	W	1085
Peso Bruto / Poids Brut / Peso Bruto / Gross Weight	kg	50
Tensão / Tension / Tension / Tension	V	230



confirmar disponibilidade  
confirmer la disponibilité  
confirmar la disponibilidad  
confirm the availability

 Máquina de secar e polir copos com secagem com ar quente. Com estrutura em aço inox

 Machine de séchage et de polissage avec séchage à l'air chaud. Avec structure en acier inoxydable

 Máquina de secado y pulir vasos con secado con aire caliente. Con estructura de acero inoxidable

 Cups drying and polishing machine with hot air drying. With stainless steel structure



MODELO / MODÈLE / MODELO / MODEL CÓDIGO / CODE / CÓDIGO / CODE		UDMSPC002 5200.100
<b>Preço / Prix / Precio / Price</b>	€	<b>2.061,00</b>
Dimensões / Dimensions / Dimensiones	mm	360x340x510
Peças / Pièces / Pieças / Pieces	h	300-360
Potência Total / Puissance Total / Potência Total / Total Power	kW	1,49
Peso Bruto / Poids Brut / Peso Bruto / Gross Weight	kg	30
Tensão / Tension / Tension / Tension	V	230





MODELO / MODÈLE / MODELO / MODEL CÓDIGO / CODE / CÓDIGO / CODE		UDMSPC001 5200.105
<b>Preço / Prix / Precio / Price</b>	€	<b>2.595,00</b>
Dimensões / Dimensions / Dimensiones	mm	595x322x510
Peças / Pièces / Pieças / Pieces	h	600-720
Potência Total / Puissance Total / Potência Total / Total Power	kW	2,62
Peso Bruto / Poids Brut / Peso Bruto / Gross Weight	kg	35
Tensão / Tension / Tension / Tension	V	230









 Máquina construída em aço inox; Tampa de carga equipada com mola a gás; Interruptor de comando ON/OFF; Termómetro de temperatura indicador da temperatura do banho de desincrustação; Lâmpada sinalizadora do aquecimento; Detergente opcional com alto poder desincrustante, capaz de eliminar a sujidade mais persistente, graças à ação combinada da água à temperatura de 80°C; Máquina concebida para remover incrustações de gordura e carvão dos diversos utensílios de cozinha: panelas, travessas, filtros, exaustores, tabuleiros aço inox e alumínio.

 Machine construite en acier inoxydable; Couvercle de chargement équipé d'un ressort à gaz; Interrupteur de commande ON/OFF; Thermomètre de température indiquant la température du bain de détartrage; Lampe témoin de chauffage; Détergent en option à haute pouvoir détartrant capable d'éliminer les salissures les plus tenaces, grâce à l'action combinée de l'eau à une température de 80°C; Machine conçue pour éliminer les incrustations de graisse et de carbone de différents ustensiles de cuisine: casseroles, plats de service, filtres, hottes aspirantes, plateaux en acier inoxydable et en aluminium.

 Máquina construída en acero inoxidable, tapa de carga equipada con resorte de gas, interruptor de comando ON/OFF; Termómetro de temperatura que indica la temperatura del baño de descalcificación Lámpara indicadora de calentamiento; Detergente opcional con alto poder desincrustante capaz de eliminar la suciedad más persistente, gracias a la acción combinada del agua a una temperatura de 80°C; Máquina diseñada para eliminar grasas e incrustaciones de carbón de diferentes utensilios de cocina: sartenes, fuentes, filtros, campanas extractoras, bandejas de acero inoxidable y aluminio.

 Machine built in stainless steel; Loading lid equipped with gas spring; ON/OFF command switch; Temperature thermometer indicating the temperature of the descaling bath; Heating indicator lamp; High descaling power detergent as optional, capable of eliminating the most persistent dirt, thanks to the combined action of water at a temperature of 80°C; Machine designed to remove grease and carbon incrustations from different kitchen utensils: pans, serving dishes, filters, extractor hoods, stainless steel and aluminum trays.

**Limpeza rápida das sujidades mais difíceis**  
Nettoyage rapide de la saleté plus difficile  
Limpieza rápida de la suciedad más difícil  
Quick cleaning of the dirt harder



**DETERGENTE**  
3200.230  
573,00



MODELO / MODÈLE / MODELO / MODEL CÓDIGO / CODE / CÓDIGO / CODE	180LT 3200.235	260LT 3200.240	340LT 3200.245
<b>Preço / Prix / Precio / Price</b>	<b>€ 6.803,00</b>	<b>7.515,00</b>	<b>9.186,00</b>
Dimensões / Dimensions / Dimensiones	mm 700x600x940	800x700x940	1000x700x940
Potência Total / Puissance Total / Potência Total / Total Power	kW 1,5	1,8	3
Peso Líquido-Bruto / Poids Net-Brut / Peso Neto-Bruto / Net-Gross Weight	kg 70/100	85/-	100/-
Tensão / Tension / Tension / Tension	V 230	230	230



MODELO / MODÈLE / MODELO / MODEL CÓDIGO / CODE / CÓDIGO / CODE	440LT 3200.250	560LT 3200.255
<b>Preço / Prix / Precio / Price</b>	<b>€ 12.199,00</b>	<b>15.487,00</b>
Dimensões / Dimensions / Dimensiones	mm 1250x700x1000	1550x700x1000
Potência Total / Puissance Total / Potência Total / Total Power	kW 5,4	6
Peso Líquido-Bruto / Poids Net-Brut / Peso Neto-Bruto / Net-Gross Weight	kg 170/-	190/-
Tensão / Tension / Tension / Tension	V 230	400

**RESTAURAÇÃO / COZEDURA**  
RESTAURATION / CUISSON  
RESTAURACIÓN / COCCIÓN  
RESTAURANT INDUSTRY / COOKING





FUTURMAT



confirmar disponibilidade  
confirmer la disponibilité  
confirmar la disponibilidad  
confirm the availability

MÁQUINAS DE CAFÉ 2 GR  
MACHINES À CAFÉ 2 GR  
MÁQUINAS DE CAFÉ 2 GR  
COFFEE MACHINES 2 GR



Inclui a motobomba. O depurador é opcional.  
Moteurpompe inclus. Incluant pas épurateur.  
Motobomba incluida. No Incluyen depurador.  
Motorpump included. Does not include purifier.

MODELO / MODÈLE / MODELO / MODEL CÓDIGO / CODE / CÓDIGO / CODE		OTTIMA EVO ELETTRONICA 2011.440	OTTIMA EVO ELETTRONICA 2011.442
<b>Preço / Prix / Precio / Price</b>	€	<b>3.519,00</b>	<b>3.519,00</b>
Dimensões / Dimensions / Dimensiones	mm	710x520x420	710x520x420
Caldeira / Chaudière / Caldera / Boiler	lt	11	11
Grupos / Groupes / Grupos / Groups	nr	2	2
Peso Líquido / Poids Net / Peso Neto / Net Weight	kg	49	49
Potência / Puissance / Potencia / Power	W	2800	2800
Tensão / Tensión / Tensión / Tension	V	400*	400*

\* Bifásica com neutro / Biphasique avec neutre / Bifásico con neutro / Biphasic with neutral



**Não inclui depurador nem motobomba**  
Incluant pas épurateur et moteurpompe  
No Incluyen depurador y motobomba  
Doens not Include purifier and motorpump



**Inclui a motobomba. O depurador é opcional.**  
Moteurpompe inclus. Incluant pas épurateur.  
Motobomba incluida. No Incluyen depurador.  
Motorpump included. Does not Include purifier.



**Não inclui depurador nem motobomba**  
Incluant pas épurateur et moteurpompe  
No Incluyen depurador y motobomba  
Doens not Include purifier and motorpump



**Inclui a motobomba. O depurador é opcional.**  
Moteurpompe inclus. Incluant pas épurateur.  
Motobomba incluida. No Incluyen depurador.  
Motorpump included. Does not Include purifier.



**Inclui a motobomba. O depurador é opcional.**  
Moteurpompe inclus. Incluant pas épurateur.  
Motobomba incluida. No Incluyen depurador.  
Motorpump included. Does not Include purifier.



**Inclui a motobomba. O depurador é opcional.**  
Moteurpompe inclus. Incluant pas épurateur.  
Motobomba incluida. No Incluyen depurador.  
Motorpump included. Does not Include purifier.

\* Bifásica com neutro / Biphásique avec neutre / Bifásico con neutro / Biphasic with neutral

MODELO / MODÈLE / MODELO / MODEL CÓDIGO / CODE / CÓDIGO / CODE		PULSER 2011.025
<b>Preço / Prix / Precio / Price</b>	€	<b>2.923,00</b>
Dimensões / Dimensions / Dimensiones	mm	730x530x460
Caldeira / Chaudière / Caldera / Boiler	lt	11
Grupos / Groupes / Grupos / Groups	nr	2
Peso Líquido / Poids Net / Peso Neto / Net Weight	kg	57
Potência / Puissance / Potencia / Power	w	2600
Tensão / Tension / Tensión / Tension	v	230



MODELO / MODÈLE / MODELO / MODEL CÓDIGO / CODE / CÓDIGO / CODE		CEE ELETRÓNICA 2011.032A
<b>Preço / Prix / Precio / Price</b>	€	<b>3.382,00</b>
Dimensões / Dimensions / Dimensiones	mm	730x530x460
Caldeira / Chaudière / Caldera / Boiler	lt	11
Grupos / Groupes / Grupos / Groups	nr	2
Peso Líquido / Poids Net / Peso Neto / Net Weight	kg	57
Potência / Puissance / Potencia / Power	w	2600
Tensão / Tension / Tensión / Tension	v	230



MODELO / MODÈLE / MODELO / MODEL CÓDIGO / CODE / CÓDIGO / CODE		PULSER LUXUS 2011.022
<b>Preço / Prix / Precio / Price</b>	€	<b>3.348,00</b>
Dimensões / Dimensions / Dimensiones	mm	730x530x460
Caldeira / Chaudière / Caldera / Boiler	lt	11
Grupos / Groupes / Grupos / Groups	nr	2
Peso Líquido / Poids Net / Peso Neto / Net Weight	kg	57
Potência / Puissance / Potencia / Power	w	2600
Tensão / Tension / Tensión / Tension	v	230



MODELO / MODÈLE / MODELO / MODEL CÓDIGO / CODE / CÓDIGO / CODE		LUXUS CEE 2011.020
<b>Preço / Prix / Precio / Price</b>	€	<b>3.613,00</b>
Dimensões / Dimensions / Dimensiones	mm	730x530x460
Caldeira / Chaudière / Caldera / Boiler	lt	11
Grupos / Groupes / Grupos / Groups	nr	2
Peso Líquido / Poids Net / Peso Neto / Net Weight	kg	57
Potência / Puissance / Potencia / Power	w	2600
Tensão / Tension / Tensión / Tension	v	230



MODELO / MODÈLE / MODELO / MODEL CÓDIGO / CODE / CÓDIGO / CODE		ARIETE F3 ELETRÓNICA 2011.450
<b>Preço / Prix / Precio / Price</b>	€	<b>5.986,00</b>
Dimensões / Dimensions / Dimensiones	mm	770x570x460
Caldeira / Chaudière / Caldera / Boiler	lt	13
Grupos / Groupes / Grupos / Groups	nr	2
Peso Líquido / Poids Net / Peso Neto / Net Weight	kg	63
Potência / Puissance / Potencia / Power	w	3500
Tensão / Tension / Tensión / Tension	v	400*

MODELO / MODÈLE / MODELO / MODEL CÓDIGO / CODE / CÓDIGO / CODE		ARIETE F3 DISPLAY 2011.452
<b>Preço / Prix / Precio / Price</b>	€	<b>6.792,00</b>
Dimensões / Dimensions / Dimensiones	mm	770x570x460
Caldeira / Chaudière / Caldera / Boiler	lt	13
Grupos / Groupes / Grupos / Groups	nr	2
Peso Líquido / Poids Net / Peso Neto / Net Weight	kg	63
Potência / Puissance / Potencia / Power	w	3500
Tensão / Tension / Tensión / Tension	v	400*

**FUTURMAT**

confirmar disponibilidade  
confirmar la disponibilité  
confirmar la disponibilidad  
confirm the availability

**MÁQUINAS DE CAFÉ 3 GR**  
MACHINES À CAFÉ 3 GR  
MÁQUINAS DE CAFÉ 3 GR  
COFFEE MACHINES 3 GR



**Não inclui depurador nem motobomba**  
Incluant pas épurateur et moteurpompe  
No Incluyen depurador y motobomba  
Does not Include purifier and motorpump



**Inclui a motobomba. O depurador é opcional.**  
Moteurpompe inclus. Incluant pas épurateur.  
Motobomba incluida. No Incluyen depurador.  
Motorpump included. Does not Include purifier.



**Inclui a motobomba. O depurador é opcional.**  
Moteurpompe inclus. Incluant pas épurateur.  
Motobomba incluida. No Incluyen depurador.  
Motorpump included. Does not Include purifier.



**Inclui a motobomba. O depurador é opcional.**  
Moteurpompe inclus. Incluant pas épurateur.  
Motobomba incluida. No Incluyen depurador.  
Motorpump included. Does not Include purifier.

MODELO / MODÈLE / MODELO / MODEL CÓDIGO / CODE / CÓDIGO / CODE		3G.CEE LUXUS 2011.026
<b>Preço / Prix / Precio / Price</b>	€	<b>4.298,00</b>
Dimensões / Dimensions / Dimensiones	mm	900x530x460
Caldeira / Chaudière / Caldera / Boiler	lt	18
Grupos / Groupes / Grupos / Groups	nr	3
Peso Líquido / Poids Net / Peso Neto / Net Weight	kg	71
Potência / Puissance / Potencia / Power	w	3700
Tensão / Tension / Tensión / Tension	v	400*



MODELO / MODÈLE / MODELO / MODEL CÓDIGO / CODE / CÓDIGO / CODE		3 GR. ELETRÓNICA 2011.033
<b>Preço / Prix / Precio / Price</b>	€	<b>4.074,00</b>
Dimensões / Dimensions / Dimensiones	mm	910x525x460
Caldeira / Chaudière / Caldera / Boiler	lt	18
Grupos / Groupes / Grupos / Groups	nr	3
Peso Líquido / Poids Net / Peso Neto / Net Weight	kg	76
Potência / Puissance / Potencia / Power	w	4200
Tensão / Tension / Tensión / Tension	v	230



MODELO / MODÈLE / MODELO / MODEL CÓDIGO / CODE / CÓDIGO / CODE		ARIETE F3 3 GR. ELETRÓNICA 2011.455
<b>Preço / Prix / Precio / Price</b>	€	<b>7.236,00</b>
Dimensões / Dimensions / Dimensiones	mm	940x570x460
Caldeira / Chaudière / Caldera / Boiler	lt	18
Grupos / Groupes / Grupos / Groups	nr	3
Peso Líquido / Poids Net / Peso Neto / Net Weight	kg	76
Potência / Puissance / Potencia / Power	w	4600
Tensão / Tension / Tensión / Tension	v	400*

MODELO / MODÈLE / MODELO / MODEL CÓDIGO / CODE / CÓDIGO / CODE		ARIETE F3 3 GR. DISPLAY 2011.457
<b>Preço / Prix / Precio / Price</b>	€	<b>8.112,00</b>
Dimensões / Dimensions / Dimensiones	mm	940x570x460
Caldeira / Chaudière / Caldera / Boiler	lt	18
Grupos / Groupes / Grupos / Groups	nr	3
Peso Líquido / Poids Net / Peso Neto / Net Weight	kg	76
Potência / Puissance / Potencia / Power	w	4600
Tensão / Tension / Tensión / Tension	v	400*

#### OPCIONAIS / OPTIONNELLES / OPCIONALES / OPTIONALS

Cód.	MODELO / MODÈLE / MODELO / MODEL	€
2011.114	DESCALCIFICADOR C150 ST	<b>278,00</b>
2011.110	DEPURADOR 8 lts	<b>139,00</b>
2011.116	DESCALCIFICADOR C300 ST	<b>370,00</b>

\* Bifásica com neutro / Biphásique avec neutre / Bifásico con neutro / Biphasic with neutral



Motobomba incorporada. Entrada de água automática. Caldeira de cobre com tubos térmicos e termosifão independentes para cada grupo. Tabuleiro inferior em aço inox.



Pompe intégrée. Entrée automatique de l'eau. Chaudière en cuivre avec tubes thermiques et thermosiphon indépendants pour chaque groupe. Plateau inférieur en acier inoxydable.



Bomba incorporada. Entrada de agua automática. Caldera de cobre con tubos térmicos y termosifón independientes para cada grupo. Bandeja inferior en acero inoxidable.



Pump incorporated. Automatic water entry. Copper boiler with independent thermal pipes and thermosiphon for each group. Bottom tray in stainless steel.



**Não inclui depurador nem motobomba**  
Incluant pas épurateur et moteurpompe  
No Incluyen depurador y motobomba  
Does not include purifier and motorpump

MODELO / MODÈLE / MODELO / MODEL CÓDIGO / CODE / CÓDIGO / CODE	CEE ELETRON.C/E A 2011.034A
<b>Preço / Prix / Precio / Price</b>	<b>€ 4.697,00</b>
Dimensões / Dimensions / Dimensiones	mm 1150x525x460
Caldeira / Chaudière / Caldera / Boiler	lt 24
Grupos / Groupes / Grupos / Groups	nr 4
Peso Líquido / Poids Net / Peso Neto / Net Weight	kg 95
Potência / Puissance / Potencia / Power	W 5000
Tensão / Tension / Tensión / Tension	V 230



**Não inclui depurador nem motobomba**  
Incluant pas épurateur et moteurpompe  
No Incluyen depurador y motobomba  
Does not include purifier and motorpump

MODELO / MODÈLE / MODELO / MODEL CÓDIGO / CODE / CÓDIGO / CODE	CEE ELETRON.C/E A 2011.034
<b>Preço / Prix / Precio / Price</b>	<b>€ 4.901,00</b>
Dimensões / Dimensions / Dimensiones	mm 1150x525x460
Caldeira / Chaudière / Caldera / Boiler	lt 24
Grupos / Groupes / Grupos / Groups	nr 4
Peso Líquido / Poids Net / Peso Neto / Net Weight	kg 95
Potência / Puissance / Potencia / Power	W 5000
Tensão / Tension / Tensión / Tension	V 230





FUTURMAT

MÁQUINAS DE CAFÉ  
MACHINES À CAFÉ  
MÁQUINAS DE CAFÉ  
OTTIMA COFFEE MACHINES



Máquina de Café Expresso alta qualidade com sistema de pré-infusão.  
Moimho de alta precisão, silencioso.  
7 botões para programar 14 bebidas diferentes.  
Sistema inovador de programação, através de cartão electrónico para a quantidade de água e café moído.  
Frigorífico adicional para manter fresco o leite durante 3 a 4 dias a 2°C/3°C.  
Lavagem Automática.  
Programa e diagnóstico em 7 idiomas.  
Saída de café ajustável em altura, 80 a 150 mm.  
Capacidade para 160 cafés/hora e 20 litros de água quente.



Machine à expresso de haute qualité avec système de pré-infusion.  
Broyeur de haute précision, silencieux.  
7 boutons pour programmer 14 boissons différentes.  
Système de programmation, via carte électronique, de la quantité d'eau et de café moulu.  
Réfrigérateur supplémentaire pour conserver le lait au frais pendant 3 à 4 jours à 2°C/3°C.  
Lavage automatique.  
Programmation et diagnostic en 7 langues.  
Sortie café réglable en hauteur de 80 à 150 mm.  
Capacité de 160 cafés/heure et 20 litres d'eau chaude.



Máquina de espresso de alta calidad con sistema de preinfusión.  
Molino de alta precisión, silencioso.  
7 botones para programar 14 bebidas diferentes.  
Innovador sistema de programación, mediante tarjeta electrónica, para la cantidad de agua y café molido.  
Refrigerador adicional para mantener la leche fresca durante 3 a 4 días a 2 ° C / 3 ° C.  
Lavado automático.  
Programa y diagnóstico en 7 idiomas.  
Salida de café regulable en altura, de 80 a 150 mm.  
Capacidad para 160 cafés / hora y 20 litros de agua caliente.



High quality espresso machine with pre-infusion system.  
High precision mill, silent.  
7 buttons to program 14 different drinks.  
Innovative programming system, via electronic card, for the amount of water and ground coffee.  
Additional fridge to keep milk fresh for 3 to 4 days at 2°C/3°C.  
Automatic Wash.  
Program and diagnostics in 7 languages.  
Height adjustable coffee outlet, 80 to 150 mm.  
Capacity for 160 coffees/hour and 20 liters of hot water.



NEVEIRA GRANDE  
2011.152  
1.459,00  
500x525x500



COMPACTA



MODELO / MODÈLE / MODELO / MODEL CÓDIGO / CODE / CÓDIGO / CODE		COMPACTA 2011.151
Preço / Prix / Precio / Price	€	12.494,00
Dimensões / Dimensions / Dimensiones	mm	600x320x700
Caldeira / Chaudière / Caldera / Boiler	lt	5,7
Grupos / Groupes / Grupos / Groups	nr	2
Peso Líquido / Poids Net / Peso Neto / Net Weight	kg	50
Potência / Puissance / Potencia / Power	W	2200
Tensão / Tension / Tensión / Tension	V	230



confirmar disponibilidade  
confirmer la disponibilité  
confirmar la disponibilidad  
confirm the availability



opcional  
optionnel  
opcional  
optional



**Modelo RUBY** com bomba vibratória e abastecimento de água manual para recipiente.  
**Modelo RUBYPRO** com bomba giratória e entrada de água automática.

Fornecido com porta filtro e saída permutável para duas chávenas.

Incorpora componentes nos modelos para uso profissional: grupo, porta filtro, válvulas solenóides, torneiras de vapor/água.

Todas as versões adaptadas para cápsulas e monodoses.

**EXPRESSO**

O seu **moinho de grãos integrado**, com capacidade de 250gr, permite moer e recuperar a quantidade desejada diretamente no coador.

A moagem do grão pode ser configurada até 15 tamanhos diferentes, permitindo o ajuste da intensidade do seu café.

Reservatório de água removível de 2,7 litros.

Programa de seleção de 1 a 2 chávenas e uma dosagem personalizada. Pode preparar bebidas lácteas com espuma cremosa graças ao bico de vapor.

Elegante design de aço inoxidável e estilo retro.

Ampla gama de acessórios incluída. Inclui: 2 filtros de aço inoxidável simples e duplos, 2 filtros pressurizados de aço inoxidável simples e duplos, colher medidora e calcador de café.



**Modèle RUBY** avec pompe vibratoire et alimentation manuel de l'eau pour récipient. **Modèle RUBYPRO** avec pompe rotative et entrée d'eau automatique.

Fournis avec 1 tasse portefiltre et interchangeable deux dribbleur de coupe.

Construit avec des composants utilisés sur modèles professionnels de la restauration: le groupe, porte-filtre, solénoïdes, vapeur / robinets d'eau.

Toutes les versions adaptées pour capsules et monodoses.

**EXPRESSO**

Son moulin à grains intégré, d'une capacité de 250gr, vous permet de mouler et de récupérer la quantité désirée directement dans la passoire.

La mouture des grains peut être configurée jusqu'à 15 tailles différentes, ce qui vous permet d'ajuster l'intensité de votre café. Réservoir d'eau amovible de 2,7 litres.

Programme de sélection de 1 à 2 tasses et un dosage personnalisé. Vous pouvez préparer des boissons lactières avec de la mousse crémeuse grâce à la buse à vapeur.

Design élégant en acier inoxydable et style rétro. Large gamme d'accessoires inclus.

Comprend: 2 filtres simples et doubles en acier inoxydable, 2 filtres pressurisés simples et doubles en acier inoxydable, cuillère à mesurer et presse-café.



**Modelo RUBY** con bomba vibratoria y suministro de agua manual para recipiente. **Modelo RUBYPRO** con bomba rotativa de entrada de agua automática.

Se suministra con porta filtro para una taza y salida intercambiable para dos tazas.

Incorpora componentes en modelos para uso profesional: grupo, porta filtro, electroválvulas, grifos de vapor y de agua.

Todas las versiones adaptadas a cápsulas y monodoses.

**EXPRESSO**

Su molino de grano integrado, con una capacidad de 250gr, permite moer y recuperar la cantidad deseada directamente en el colador.

La molienda de granos se puede configurar hasta en 15 tamaños diferentes, lo que le permite ajustar la intensidad de su café.

Depósito de agua extraíble de 2,7 litros.

Programa de selección de 1 a 2 tazas y una dosificación personalizada. Puedes preparar bebidas lácteas con espuma cremosa gracias a la boquilla de vapor.

Elegante diseño de acero inoxidable y estilo retro. Ampla gama de acessórios incluídos.

Incluye: 2 filtros simples y dobles de acero inoxidable, 2 filtros pressurizados de acero inoxidable simples y dobles, cuchara medidora y prensa de café.



**Model RUBY** with vibratory pump and water manual supply for recipient. **Model RUBYPRO** with rotary pump and automatic water inlet.

Supplied with 1 cup filter holder and interchangeable two cup dribbler.

Built with components used on professional foodservice models: group, filter holder, solenoids, steam/water taps.

All versions adapted for capsules and monodoses.

**EXPRESSO**

Its integrated grain mill, with a capacity of 250gr, allows you to grind and recover the desired amount directly in the strainer.

Grain grinding can be configured up to 15 different sizes, allowing you to adjust the intensity of your coffee.

Removable water tank of 2.7 liters. Selection program of 1 to 2 cups and a personalized dosage. You can prepare dairy drinks with creamy foam thanks to the steam nozzle.

Elegant stainless steel design and retro style. Wide range of accessories included. Includes: 2 single and double stainless steel filters, 2 single and double stainless steel pressurized filters, measuring spoon and coffee presser.



**NOVO  
NOUVEAU  
NUEVO  
NEW**

**Moinho Integrado**  
Moulin intégré  
Molino integrado  
Integrated mill



MODELO / MODÈLE / MODELO / MODEL CÓDIGO / CODE / CÓDIGO / CODE		EXPRESSO 2230.910
<b>Preço / Prix / Precio / Price</b>	€	<b>813,00</b>
Dimensões / Dimensions / Dimensiones	mm	304x405x415
Depósito Água / Dépôt d'eau / Depósito Agua / Water Tank	lt	2,7
Depósito Grão / Dépôt grain / Depósito Grano / Grain Tank	gr	250
Grupos / Groupes / Grupos / Groups	nr	1
Peso Líquido / Poids Net / Peso Neto / Net Weight	kg	8
Potência / Puissance / Potencia / Power	W	1620
Tensão / Tension / Tensión / Tension	V	230

MODELO / MODÈLE / MODELO / MODEL CÓDIGO / CODE / CÓDIGO / CODE		RUBY 1GR ELET. 2011.470
<b>Preço / Prix / Precio / Price</b>	€	<b>2.045,00</b>
Dimensões / Dimensions / Dimensiones	mm	310x510x370
Cap. do depósito / Cap. du dépôt / Cap. de depósito / Deposit capacity	lt	3
Caldeira / Chaudière / Caldera / Boiler	lt	1,5
Grupos / Groupes / Grupos / Groups	nr	1
Peso Líquido / Poids Net / Peso Neto / Net Weight	kg	18
Potência / Puissance / Potencia / Power	W	1640
Tensão / Tension / Tensión / Tension	V	230

MODELO / MODÈLE / MODELO / MODEL CÓDIGO / CODE / CÓDIGO / CODE		RUBY PRO 1GR ELET. 2011.462
<b>Preço / Prix / Precio / Price</b>	€	<b>2.434,00</b>
Dimensões / Dimensions / Dimensiones	mm	430x510x370
Cap. do depósito / Cap. du dépôt / Cap. de depósito / Deposit capacity	lt	-
Caldeira / Chaudière / Caldera / Boiler	lt	5
Grupos / Groupes / Grupos / Groups	nr	1
Peso Líquido / Poids Net / Peso Neto / Net Weight	kg	25
Potência / Puissance / Potencia / Power	W	2500
Tensão / Tension / Tensión / Tension	V	230

**Painel Controlo Modelo Automático**  
Panneau de contrôle Modèle Automatique  
Panel de Control - Modelo Automático  
Control Panel - Automatic Model





**FUTURMAT****MOINHOS DE CAFÉ**  
MOULIN À CAFÉ  
MOLINOS DE CAFÉ  
COFFEE GRINDERSilencioso  
Silencieux  
Silencioso  
Silent**77**  
db

AUTO

MODELO / MODÈLE / MODELO / MODEL CÓDIGO / CODE / CÓDIGO / CODE	AUTO. CT 2 CINZENTO 2011.222	
<b>Preço / Prix / Precio / Price</b>	€	<b>616,00</b>
Dimensões / Dimensions / Dimensiones	mm	220x410x620
Cap. doseador / Cap. dosificateur / Cap. dosificador / Doser capacity	gr	600
Capacidade tremoinha / Capacité trémie / Capacidad Tolva / Hopper capacity	kg	2
Rotações / Rotations / Rotaciones / Rotations	rpm	1300
Peso Líquido / Poids Net / Peso Neto / Net Weight	kg	9
Potência / Puissance / Potencia / Power	W	356
Tensão / Tension / Tensión / Tension	V	230



MODELO / MODÈLE / MODELO / MODEL CÓDIGO / CODE / CÓDIGO / CODE	DECAF S/ DOSIFICADOR 2011.046	
<b>Preço / Prix / Precio / Price</b>	€	<b>484,00</b>
Dimensões / Dimensions / Dimensiones	mm	170x340x430
Cap. doseador / Cap. dosificateur / Cap. dosificador / Doser capacity	gr	500
Capacidade tremoinha / Capacité trémie / Capacidad Tolva / Hopper capacity	kg	-
Rotações / Rotations / Rotaciones / Rotations	rpm	-
Peso Líquido / Poids Net / Peso Neto / Net Weight	kg	6
Potência / Puissance / Potencia / Power	W	270
Tensão / Tension / Tensión / Tension	V	230



MODELO / MODÈLE / MODELO / MODEL CÓDIGO / CODE / CÓDIGO / CODE	FM LUXUS 2011.042	
<b>Preço / Prix / Precio / Price</b>	€	<b>794,00</b>
Dimensões / Dimensions / Dimensiones	mm	330x285x605
Cap. doseador / Cap. dosificateur / Cap. dosificador / Doser capacity	gr	600
Capacidade tremoinha / Capacité trémie / Capacidad Tolva / Hopper capacity	kg	2
Rotações / Rotations / Rotaciones / Rotations	rpm	-
Peso Líquido / Poids Net / Peso Neto / Net Weight	kg	19
Potência / Puissance / Potencia / Power	W	300
Tensão / Tension / Tensión / Tension	V	230



MODELO / MODÈLE / MODELO / MODEL CÓDIGO / CODE / CÓDIGO / CODE	GOURMET 2011.044	
<b>Preço / Prix / Precio / Price</b>	€	<b>522,00</b>
Dimensões / Dimensions / Dimensiones	mm	170x340x430
Cap. doseador / Cap. dosificateur / Cap. dosificador / Doser capacity	gr	300
Capacidade tremoinha / Capacité trémie / Capacidad Tolva / Hopper capacity	kg	0,5
Rotações / Rotations / Rotaciones / Rotations	rpm	1300
Peso Líquido / Poids Net / Peso Neto / Net Weight	kg	13
Potência / Puissance / Potencia / Power	W	497
Tensão / Tension / Tensión / Tension	V	230



AUTO

MODELO / MODÈLE / MODELO / MODEL CÓDIGO / CODE / CÓDIGO / CODE	Q10 2011.223	
<b>Preço / Prix / Precio / Price</b>	€	<b>1.778,00</b>
Dimensões / Dimensions / Dimensiones	mm	200x370x630
Cap. doseador / Cap. dosificateur / Cap. dosificador / Doser capacity	gr	-
Capacidade tremoinha / Capacité trémie / Capacidad Tolva / Hopper capacity	kg	1,5
Rotações / Rotations / Rotaciones / Rotations	rpm	1250
Peso Líquido / Poids Net / Peso Neto / Net Weight	kg	16
Potência / Puissance / Potencia / Power	W	525
Tensão / Tension / Tensión / Tension	V	230



AUTO

MODELO / MODÈLE / MODELO / MODEL CÓDIGO / CODE / CÓDIGO / CODE	TANGO 2 2011.218	
<b>Preço / Prix / Precio / Price</b>	€	<b>1.576,00</b>
Dimensões / Dimensions / Dimensiones	mm	400x250x790
Cap. doseador / Cap. dosificateur / Cap. dosificador / Doser capacity	gr	-
Capacidade tremoinha / Capacité trémie / Capacidad Tolva / Hopper capacity	kg	2 + 2
Rotações / Rotations / Rotaciones / Rotations	rpm	1300
Peso Líquido / Poids Net / Peso Neto / Net Weight	kg	33
Potência / Puissance / Potencia / Power	W	450
Tensão / Tension / Tensión / Tension	V	230

automático  
automatique  
automático  
automaticconfirmar disponibilidade  
confirmer la disponibilité  
confirmar la disponibilidad  
confirm the availability



Distribuidor de balcão, especialmente concebido para a preparação e a conservação de chocolate e outras bebidas quentes.



Distributeur de comptoir, spécialement conçu pour la préparation et la conservation du chocolat et autres boissons chaudes.



Distribuidor de mostrador, especialmente para verter el chocolate y otras bebidas calientes.



Top distributor, especially conceived for chocolate and other hot drinks.



MODELO / MODÈLE / MODELO / MODEL CÓDIGO / CODE / CÓDIGO / CODE	DELICE PRETA 2016.042	
<b>Preço/ Prix / Precio / Price</b>	€	<b>742,00</b>
Dimensões / Dimensions / Dimensiones	mm	240x290x410
Capacidade / Capacidad / Capacite / Capacidad / Capacity	lt	3
Peso Líquido / Poids Net / Peso Neto / Net Weight	kg	5-6
Potência / Puissance / Potencia / Power	W	800
Tensão / Tension / Tensión / Tension	V	230



MODELO / MODÈLE / MODELO / MODEL CÓDIGO / CODE / CÓDIGO / CODE	DELICE DOURADA 2016.062	
<b>Preço/ Prix / Precio / Price</b>	€	<b>874,00</b>
Dimensões / Dimensions / Dimensiones	mm	240x290x410
Capacidade / Capacidad / Capacite / Capacidad / Capacity	lt	3
Peso Líquido / Poids Net / Peso Neto / Net Weight	kg	5-6
Potência / Puissance / Potencia / Power	W	800
Tensão / Tension / Tensión / Tension	V	230



MODELO / MODÈLE / MODELO / MODEL CÓDIGO / CODE / CÓDIGO / CODE	DELICE PRETA 2016.044	
<b>Preço/ Prix / Precio / Price</b>	€	<b>893,00</b>
Dimensões / Dimensions / Dimensiones	mm	240x320x490
Capacidade / Capacidad / Capacite / Capacidad / Capacity	lt	5
Peso Líquido / Poids Net / Peso Neto / Net Weight	kg	6-7
Potência / Puissance / Potencia / Power	W	800
Tensão / Tension / Tensión / Tension	V	230



MODELO / MODÈLE / MODELO / MODEL CÓDIGO / CODE / CÓDIGO / CODE	DELICE PRATEADA 2016.050	
<b>Preço/ Prix / Precio / Price</b>	€	<b>1.055,00</b>
Dimensões / Dimensions / Dimensiones	mm	240x320x490
Capacidade / Capacidad / Capacite / Capacidad / Capacity	lt	5
Peso Líquido / Poids Net / Peso Neto / Net Weight	kg	6-7
Potência / Puissance / Potencia / Power	W	800
Tensão / Tension / Tensión / Tension	V	230



MODELO / MODÈLE / MODELO / MODEL CÓDIGO / CODE / CÓDIGO / CODE	DELICE DOURADA 2016.060	
<b>Preço/ Prix / Precio / Price</b>	€	<b>1.055,00</b>
Dimensões / Dimensions / Dimensiones	mm	240x320x490
Capacidade / Capacidad / Capacite / Capacidad / Capacity	lt	5
Peso Líquido / Poids Net / Peso Neto / Net Weight	kg	6-7
Potência / Puissance / Potencia / Power	W	800
Tensão / Tension / Tensión / Tension	V	230





MODELO / MODÈLE / MODELO / MODEL CÓDIGO / CODE / CÓDIGO / CODE		MELCHOC 1,5 AN 2330.014	MELCHOC 3,5 AN 2330.016	MELCHOC 6 AN 2330.018
<b>Preço / Prix / Precio / Price</b>	€	<b>422,00</b>	<b>549,00</b>	<b>667,00</b>
Dimensões / Dimensions / Dimensiones	mm	260x225x125	410x235x140	400x315x140
Capacidade / Capacidad / Capacité / Capacidad / Capacity	lt	1,5	3,5	6
Peso Líquido / Poids Net / Peso Neto / Net Weight	kg	2	2	3,8
Potência / Puissance / Potencia / Power	W	80	80	130
Tensão / Tension / Tensión / Tension	V	230	230	230



MODELO / MODÈLE / MODELO / MODEL CÓDIGO / CODE / CÓDIGO / CODE		MELCHOC 1,5X2 AN 2330.020
<b>Preço / Prix / Precio / Price</b>	€	<b>650,00</b>
Dimensões / Dimensions / Dimensiones	mm	405x260x130
Capacidade / Capacidad / Capacité / Capacidad / Capacity	lt	1,5x2
Peso Líquido / Poids Net / Peso Neto / Net Weight	kg	3,2
Potência / Puissance / Potencia / Power	W	160
Tensão / Tension / Tensión / Tension	V	230



MODELO / MODÈLE / MODELO / MODEL CÓDIGO / CODE / CÓDIGO / CODE		MELCHOC 3,5 2330.008	MELCHOC 6 2330.010	MELCHOC 9 2330.012
<b>Preço / Prix / Precio / Price</b>	€	<b>878,00</b>	<b>996,00</b>	<b>1.165,00</b>
Dimensões / Dimensions / Dimensiones	mm	230x490x260	320x490x260	380x520x260
Capacidade / Capacidad / Capacité / Capacidad / Capacity	lt	3,5	6	9
Peso Líquido / Poids Net / Peso Neto / Net Weight	kg	3	4,3	5,4
Potência / Puissance / Potencia / Power	W	80	130	200
Tensão / Tension / Tensión / Tension	V	230	230	230



MODELO / MODÈLE / MODELO / MODEL CÓDIGO / CODE / CÓDIGO / CODE		TOPCHOC 5,5 2330.002
<b>Preço / Prix / Precio / Price</b>	€	<b>12.185,00</b>
Dimensões / Dimensions / Dimensiones	mm	480x460x620
Capacidade / Capacidad / Capacité / Capacidad / Capacity	lt	5,5
Peso Líquido / Poids Net / Peso Neto / Net Weight	kg	52
Potência / Puissance / Potencia / Power	W	1100
Tensão / Tension / Tensión / Tension	V	230



MODELO / MODÈLE / MODELO / MODEL CÓDIGO / CODE / CÓDIGO / CODE		TEMPERCHOC 12 2330.004	TEMPERCHOC 24 2330.006
<b>Preço / Prix / Precio / Price</b>	€	<b>16.980,00</b>	<b>20.333,00</b>
Dimensões / Dimensions / Dimensiones	mm	505x720x1540	620x840x1540
Capacidade / Capacidad / Capacité / Capacidad / Capacity	lt	12	24
Peso Líquido / Poids Net / Peso Neto / Net Weight	kg	157	178
Potência / Puissance / Potencia / Power	W	2600	3000
Tensão / Tension / Tensión / Tension	V	400	400

**FONTE CHOCOLATE**  
FONDUE CHOCOLAT  
FONDUE CHOCOLATE  
CHOCOLATE FONDUE



MODELO / MODÈLE / MODELO / MODEL CÓDIGO / CODE / CÓDIGO / CODE		FONDUE CHOCOLATE 5 3098.004	FONDUE CHOCOLATE 6 3098.008
<b>Preço / Prix / Precio / Price</b>	€	<b>CONSULTAR</b>	<b>CONSULTAR</b>
Dimensões / Dimensions / Dimensiones	mm	330x680	330x820
Capacidade / Capacité / Capacidad / Capacity	kg	4	6
Pisos / Étages / Pisos / Floors	nr	5	6
Temperatura / Température / Temperatura / Temperature	°C	150	150
Potência-Corrente / Puissance-Courant / Potencia-Corriente / Power-Current	W-A	300-5	300-5
Peso / Poids / Peso / Weight	kg	9	10
Tensão / Tension / Tensión / Tension	V	230	230



Construídos em aço inox, com cuba interior aquecida indiretamente e amovível para fácil limpeza. Possibilidade de regulação de temperatura.



Construit en acier inoxydable, cuve intérieure chauffée indirectement et amovible pour un nettoyage facile. Possibilité de contrôle de la température.



Construido en acero inoxidable, con cuba interna calentada indirectamente y extraíble para fácil limpieza. Posibilidad de control de la temperatura.



Built in stainless steel, with indirectly heated inner vat and removable for easy cleaning. Possibility of temperature regulation.



MODELO / MODELE / MODELO / MODEL CÓDIGO / CODE / CÓDIGO / CODE		TLC 5+5LTS 2058.328
<b>Preço / Prix / Precio / Price</b>	€	<b>1.041,00</b>
Dimensões / Dimensions / Dimensiones	mm	540x310x520
Capacidade / Capacidad / Capacité/ Capacidad/ Capacity	lt	5+5
Temperatura / Temperature / Temperatura/ Temperature	°C	0-85
Peso Líquido-Bruto / Poids Net-Brut / Peso Neto-Bruto / Net-Gross Weight	kg	16-17,4
Potência / Puissance /Potência/Power	W	1200
Tensão / Tension / Tension / Tension	V	230



MODELO / MODELE / MODELO / MODEL CÓDIGO / CODE / CÓDIGO / CODE		7 LTS SEM BASE 2011.477
<b>Preço / Prix / Precio / Price</b>	€	<b>685,00</b>
Dimensões / Dimensions / Dimensiones	mm	280x280x425
Capacidade / Capacidad / Capacité/ Capacidad/ Capacity	lt	7
Temperatura / Temperature / Temperatura/ Temperature	°C	-
Peso Líquido /Poids Net /Peso Neto /Net Weight	kg	9-
Potência / Puissance /Potência/Power	W	1200
Tensão / Tension / Tension / Tension	V	230



MODELO / MODELE / MODELO / MODEL CÓDIGO / CODE / CÓDIGO / CODE		TLR030 2011.674
<b>Preço / Prix / Precio / Price</b>	€	<b>1.224,00</b>
Dimensões / Dimensions / Dimensiones	mm	410x410x750
Capacidade / Capacidad / Capacité/ Capacidad/ Capacity	lt	30
Temperatura / Temperature / Temperatura/ Temperature	°C	0-90
Peso Líquido-Bruto / Poids Net-Brut / Peso Neto-Bruto / Net-Gross Weight	kg	21
Potência / Puissance /Potência/Power	W	4000
Tensão / Tension / Tension / Tension	V	230

**DIHR**

**confirmar disponibilidade**  
 confirmer la disponibilité  
 confirmar la disponibilidad  
 confirm the availability

**LIQUIDIFICADORES**  
**LIQUIDIFICATEURS**  
**LIQUIDIFICADORAS**  
**BLENDERS**



Estrutura em aço inoxidável; Sistema de segurança com paragem automática do motor; Recipiente removível; Projetado para a preparação de frutas, bebidas vegetais e batidos. F1/F2 Inox: Copo disponível em aço inox ou policarbonato.



Structure en acier inoxydable; système e securite active avec arret automatique du moteur; recipient demontable; Conçu pour preparer des milk-shakes et boissons a base de fruits et de legumes. F1/F2 Inox: Tasse en acier inoxydable ou en polycarbonate.



Estructura en acero inoxidable; Sistema de seguro activo con apagado automático del motor, Contenedor desmontable; proyectado para preparar batidos y bebidas a base de frutas y verduras. F1/F2 Inox: Taza disponible en acero inoxidable o policarbonato.



Structure in stainless steel; Active safety system with automatic motor shutoff; removable container; designed for the preparation of fruit and vegetable drinks and shakes. F1/F2 Inox :Cup available in stainless steel or polycarbonate.



MODELO / MODÈLE / MODELO / MODEL CÓDIGO / CODE / CÓDIGO / CODE		F1 2800.510
<b>Preço / Prix / Precio/ Price</b>	€	<b>482,00</b>
Dimensões / Dimensions / Dimensiones	mm	175x230x460
Capacidade / Capacidad / Capacité / Capacidad / Capacity	lt	1,5
Peso Líquido /Poids Net /Peso Neto /Net Weight	kg	4
Potência / Puissance / Potencia / Power	w	200
Tensão / Tension / Tensión / Tension	v	230



**Copo em aço inox**  
 Tasse en acier inoxydable  
 Taza en acero inoxidable  
 Stainless steel cup

MODELO / MODÈLE / MODELO / MODEL CÓDIGO / CODE / CÓDIGO / CODE		F1 INOX 2800.512
<b>Preço / Prix / Precio/ Price</b>	€	<b>628,00</b>
Dimensões / Dimensions / Dimensiones	mm	175x230x460
Capacidade / Capacidad / Capacité / Capacidad / Capacity	lt	3
Peso Líquido /Poids Net /Peso Neto /Net Weight	kg	5,3
Potência / Puissance / Potencia / Power	w	200
Tensão / Tension / Tensión / Tension	v	230



MODELO / MODÈLE / MODELO / MODEL CÓDIGO / CODE / CÓDIGO / CODE		F2 2800.514
<b>Preço / Prix / Precio/ Price</b>	€	<b>847,00</b>
Dimensões / Dimensions / Dimensiones	mm	310x230x460
Capacidade / Capacidad / Capacité / Capacidad / Capacity	lt	1,5+1,5
Peso Líquido /Poids Net /Peso Neto /Net Weight	kg	6,65
Potência / Puissance / Potencia / Power	w	400
Tensão / Tension / Tensión / Tension	v	230



**Copo em aço inox**  
 Tasse en acier inoxydable  
 Taza en acero inoxidable  
 Stainless steel cup

MODELO / MODÈLE / MODELO / MODEL CÓDIGO / CODE / CÓDIGO / CODE		F2 INOX 2800.516
<b>Preço / Prix / Precio/ Price</b>	€	<b>1.138,00</b>
Dimensões / Dimensions / Dimensiones	mm	310x230x460
Capacidade / Capacidad / Capacité / Capacidad / Capacity	lt	3+3 inox
Peso Líquido /Poids Net /Peso Neto /Net Weight	kg	12
Potência / Puissance / Potencia / Power	w	200
Tensão / Tension / Tensión / Tension	v	230



S40 e S55 Automatic - construção em aço inox;



S40 et S55 automatique - construction en acier inoxydable;



S40 y S55 automático - Construcción de acero inoxidable;



S40 and S55 Automatic - Stainless steel construction;



MODELO / MODÈLE / MODELO / MODEL CÓDIGO / CODE / CÓDIGO / CODE		CITRUS 6 4800.006
<b>Preço / Prix / Precio / Price</b>	€	<b>527,00</b>
Dimensões / Dimensions / Dimensiones	mm	220x290x415
RPM / RPM / RPM / RPM	rpm	1450
Peso Bruto / Poids Brut / Peso Bruto / Gross Weight	kg	8,7
Potência / Puissance / Potencia / Power	W	230
Tensão / Tension / Tensión / Tension	V	230



MODELO / MODÈLE / MODELO / MODEL CÓDIGO / CODE / CÓDIGO / CODE		S40 2800.520
<b>Preço / Prix / Precio / Price</b>	€	<b>494,00</b>
Dimensões / Dimensions / Dimensiones	mm	180x220x335
RPM / RPM / RPM / RPM	rpm	-
Peso Bruto / Poids Brut / Peso Bruto / Gross Weight	kg	8,6
Potência / Puissance / Potencia / Power	W	350
Tensão / Tension / Tensión / Tension	V	230



MODELO / MODÈLE / MODELO / MODEL CÓDIGO / CODE / CÓDIGO / CODE		S55 AUTOMATIC 2800.522
<b>Preço / Prix / Precio / Price</b>	€	<b>798,00</b>
Dimensões / Dimensions / Dimensiones	mm	180x220x360
RPM / RPM / RPM / RPM	rpm	-
Peso Bruto / Poids Brut / Peso Bruto / Gross Weight	kg	11
Potência / Puissance / Potencia / Power	W	350
Tensão / Tension / Tensión / Tension	V	230



semi auto  
semi auto  
semi auto  
semi auto



automático  
automatique  
automático  
automatic



confirmar disponibilidade  
confirmer la disponibilité  
confirmar la disponibilidad  
confirm the availability



UDI



**MÁQUINAS DE SUMO DE LARANJA**  
MACHINES DE JUS D'ORANGE  
MAQUINAS DE ZUMO DE NARANJA  
ORANGE JUICERS MACHINES



MODELO / MODÈLE / MODELO / MODEL		NR.32-A
CÓDIGO / CODE / CÓDIGO / CODE		2229.005
<b>Preço/ Prix / Precio / Price</b>	<b>€</b>	<b>7.303,00</b>
Dimensões / Dimensions / Dimensiones	mm	410x600x1026
Capacidade de laranjas / Capacité d'oranges / Capacidad naranjas / Orange capacity	nr/min	20
Calibre das Laranjas / Calibre d'oranges / Calibre de las naranjas / Orange Caliber	mm	60-90
Capacidade Alimentador funil / Cap. trémie d'alimentation / Cap. de tolva alimentadora / Feeder hopper cap.	kg	10
Peso Líquido / Poids Net / Peso Neto / Net Weight	kg	61
Potência / Puissance / Potencia / Power	W	600
Tensão / Tension / Tensión / Tension	V	230



MODELO / MODÈLE / MODELO / MODEL		UDI ORANGE
CÓDIGO / CODE / CÓDIGO / CODE		3097.440
<b>Preço/ Prix / Precio / Price</b>	<b>€</b>	<b>1.916,00</b>
Dimensões / Dimensions / Dimensiones	mm	400x300x780
Capacidade de laranjas / Capacité d'oranges / Capacidad naranjas / Orange capacity	nr/min	25
Calibre das Laranjas / Calibre d'oranges / Calibre de las naranjas / Orange Caliber	mm	60-80
Capacidade Alimentador funil / Cap. trémie d'alimentation / Cap. de tolva alimentadora / Feeder hopper cap.	kg	5-7
Peso Líquido / Poids Net / Peso Neto / Net Weight	kg	41
Potência / Puissance / Potencia / Power	W	200
Tensão / Tension / Tensión / Tension	V	230



confirmar disponibilidade  
confirmer la disponibilité  
confirmar la disponibilidad  
confirm the availability



Centrifugador para sumos de fruta e verdura de baixa velocidade (slow juicer); Estrutura em contacto com os alimentos em aço inoxidável e plástico; Expulsão automática da polpa; Recipiente em plástico para resíduos e sucos; Microinterruptor de segurança na tampa; Inclui 3 filtros em aço inox (1 para gelado).



Centrifuger les jus de fruits et de légumes à basse vitesse (centrifugeuse lente); Structure en contact avec des aliments en acier inoxydable et en plastique; Éjection automatique de la pulpe; Conteneur en plastique pour déchets et jus; Microrupteur de sécurité sur le couvercle; Comprend 3 filtres en acier inoxydable (1 pour la crème glacée).



Centrifugador para sumos de fruta e verdura de baixa velocidade (slow juicer); Estrutura em contacto com os alimentos em aço inoxidável e plástico; Expulsão automática da polpa; Recipiente em plástico para resíduos e sucos; Microinterruptor de segurança na tampa; Inclui 3 filtros em aço inox (1 para gelado).



Centrifuge for low-speed fruit and vegetable juices (slow juicer); Structure in contact with food in stainless steel and plastic; Automatic ejection of the pulp; Plastic container for waste and juice; Safety microswitch on the lid; Includes 3 filters in stainless steel (1 for ice cream).



MODELO / MODÈLE / MODELO / MODEL	CE 2047/E S/COPO	
CÓDIGO / CODE / CÓDIGO / CODE	2089.040	
Preço/ Prix / Precio / Price	€	1.682,00
Dimensões / Dimensions / Dimensiones	mm	280x350x500
Peso / Poids / Peso / Weight	kg	11
Potência / Puissance / Potencia / Power	W	400
Tensão / Tension / Tensión / Tension	V	230



MODELO / MODÈLE / MODELO / MODEL	VITALJUICER	
CÓDIGO / CODE / CÓDIGO / CODE	2011.725	
Preço/ Prix / Precio / Price	€	CONSULTAR
Dimensões / Dimensions / Dimensiones	mm	258x440x492
Peso / Poids / Peso / Weight	kg	18
Potência / Puissance / Potencia / Power	W	750
Tensão / Tension / Tensión / Tension	V	230



**DIHR**

**TRITURADORES DE GELO**  
**BROYEURS À GLACE**  
**TRITURADORES DE HIELO**  
**ICE CRUSHERS**



 Equipados com um motor potente mas silencioso, utilização e limpeza fácil, ideais para bares, discotecas, restaurantes para fazer gelo picado para servir cocktails, bebidas refrescantes e para apresentação de alimentos uniformemente refrigerados.

**Modelos Ice Crusher C103/ C105** - Design compacto com caixa em aço inoxidável polido.

**Modelo Ice Breaker** - Estrutura em aço inoxidável suportada por uma barra de alumínio anodizado.

 Equipé d'un moteur puissant et silencieux, utilisation nettoyage facile, idéal pour les bars, discothèques, restaurants pour faire glace pilée pour servir des cocktails, des rafraichissements et pour la présentation des aliments uniformément refroidi. **Modèles Ice Crusher C103/C105** - Design compact avec boîte de acier inoxydable poli.

**Modèle Ice Breaker** - Structure en acier inoxydable soutenu par une barre en aluminium anodisé.

 Equipadas con un potente motor y silencioso, uso y limpieza fácil, ideal para bares, discotecas, restaurantes para hacer hielo picado para servir cócteles, bebidas refrescantes y presentación de los alimentos refrigerados uniformemente. **Modelos Ice Crusher C103/C105** - Diseño compacto en acero inoxidable pulido.

**Modelo Ice Breaker** - Estructura de acero inoxidable con soportada de una barra de aluminio anodizado.

 Equipped with a silent but powerful motor, easy use and cleaning, ideal for bars, nightclubs, restaurants to make crushed ice for serving cocktails, refreshing drinks and presentation of uniformly cooled food. **Ice Crusher C103/C105 models** - Compact design with polished stainless steel box. **Ice Breaker** - Stainless steel structure supported by an anodized aluminum bar.

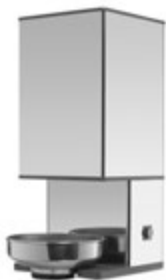

MODELO / MODELE / MODELO / MODEL	TRITURADOR DE GELO SG2	
CÓDIGO / CODE/ CÓDIGO / CODE	2800.524	
<b>Preço /Prix / Precio /Price</b>	<b>€</b>	<b>1.175,00</b>
Dimensões / Dimensions / Dimensiones	mm	220x 220x 520
Cap. Depósito / Cap. depot / Cap. deposito / Deposit capacity	kg	1
Produção / Production / Producción / Production	kg/h	100
Peso Bruto / Poids Brut / Peso Bruto / Gross Weight	kg	7
Potência / Puissance / Potência / Power	w	180
Tensão / Tension / Tension / Tension	V	230

MODELO / MODELE / MODELO / MODEL	INOX C103	
CÓDIGO / CODE/ CÓDIGO / CODE	2003.105	
<b>Preço /Prix / Precio /Price</b>	<b>€</b>	<b>1.570,00</b>
Dimensões / Dimensions / Dimensiones	mm	180x 330x 320
Cap. Depósito / Cap. depot / Cap. deposito / Deposit capacity	kg	1
Produção / Production / Producción / Production	kg/h	180
Peso Líquido-Bruto / Poids Net-Brut / Peso Neto-Bruto / Net-Gross Weight	kg	10-12
Potência / Puissance / Potência / Power	w	150
Tensão / Tension / Tension / Tension	V	230

MODELO / MODELE / MODELO / MODEL	INOX C105	
CÓDIGO / CODE/ CÓDIGO / CODE	2003.110	
<b>Preço /Prix / Precio /Price</b>	<b>€</b>	<b>2.648,00</b>
Dimensões / Dimensions / Dimensiones	mm	370x 310x 510
Cap. Depósito / Cap. depot / Cap. deposito / Deposit capacity	kg	5
Produção / Production / Producción / Production	kg/h	300
Peso Líquido-Bruto / Poids Net-Brut / Peso Neto-Bruto / Net-Gross Weight	kg	21-23
Potência / Puissance / Potência / Power	w	150
Tensão / Tension / Tension / Tension	V	230



**GR2009/A** - Espregedor + Copo Liquidificador  
**GR2014/A** - Triturador de Gelo + Espregedor + Liquidificador + Batedor  
**2021/A** - Espregedor + Copo Liquidificador + Copo Frappé  
**GR 2037** - Triturador de Gelo+Espregedor+Copo Liquidificador+2 Copos Frappé  
**GM** - Triturador de Gelo  
**GM 2** - Triturador de Gelo + Espregedor  
**GM 3** - Triturador de Gelo + Espregedor + Copo Liquidificador  
**GM 4** - Triturador de Gelo + Espregedor + Copo Liquidificador + Copo Frappé

**GR2009/A** - Presse-agrumes + Gobelet Blender  
**GR2014/A** - Broyeur à glace+ Centrifugeuse + Blender + Fouet  
**2021/A** - Presse-agrumes + Gobelet Blender + Gobelet Frappé  
**GR 2037** - Broyeur à glace+Presse-fruits+Tasse Blender+2 Verres Frappé  
**GM** - Triturateur de Glace  
**GM 2** - Triturateur de Glace + Presseur  
**GM 3** - Triturateur de Glace + Presseur + Verre Liquidificateur  
**GM 4** - Triturateur de Glace + Presseur + Verre Liquidificateur + Verre Frappé

**GR2009/A** - Exprimidor + Vaso Batidora  
**GR2014/A** - Triturador de hielo + Exprimidor + Batidora + Batidor  
**2021/A** - Exprimidor + Vaso Batidora + Vaso Frappé  
**GR 2037** - Triturador+Exprimidor+Vaso Licuadora+2 Vasos Frappé  
**GM** - Triturador de Hielo  
**GM 2** - Triturador de Hielo + Exprimidor  
**GM 3** - Triturador de Hielo + Exprimidor + Jarra Licuadora  
**GM 4** - Triturador de Hielo + Exprimidor + Jarra Licuadora + Vaso Frappé

**GR2009/A** - Juicer + Blender Cup  
**GR2014/A** - Ice Crusher + Juicer + Blender + Whisk  
**2021/A** - Juicer + Blender Cup + Frappé Cup  
**GR 2037** - Ice Crusher+Squeezer+Blender Cup+2 Frappé Glasses  
**GM** - Ice Crusher  
**GM 2** - Ice Crusher + Squeezer  
**GM 3** - Ice Crusher + Squeezer + Glass Blender  
**GM 4** - Ice Crusher + Squeezer + Glass Blender + Frappé Glass

**Várias funções. Ideais para poupar espaço.**  
**Fonctions diverses. Idéal pour économiser de l'espace.**  
**Varias funciones. Ideal para ahorrar espacio.**  
**Various functions. Ideal for saving space.**



GR2009/A

GR2014/A



2021/A

GR 2037



GM

GM 2



GM 3

GM 4

MODELO / MODÈLE / MODELO / MODEL CÓDIGO / CODE / CÓDIGO / CODE		GR2009/A 2089.010	GR2014/A 2089.012
<b>Preço / Prix / Precio / Price</b>	€	<b>1.794,00</b>	<b>2.924,00</b>
Dimensões / Dimensions / Dimensiones	mm	200x400x540	250x530x540
Capacidade / Capacidad / Capacité / Capacidad / Capacity	lt	-	-
Peso Líquido / Poids Net / Peso Neto / Net Weight	kg	15	16
Potência / Puissance / Potencia / Power	W	550	650
Tensão / Tension / Tensión / Tension	V	230	230

MODELO / MODÈLE / MODELO / MODEL CÓDIGO / CODE / CÓDIGO / CODE		2021/A 2089.020	GR 2037 2089.027
<b>Preço / Prix / Precio / Price</b>	€	<b>2.191,00</b>	<b>3.717,00</b>
Dimensões / Dimensions / Dimensiones	mm	330x420x540	250x530x540
Capacidade / Capacidad / Capacité / Capacidad / Capacity	lt	-	-
Peso Líquido / Poids Net / Peso Neto / Net Weight	kg	15	16
Potência / Puissance / Potencia / Power	W	700	650
Tensão / Tension / Tensión / Tension	V	230	230

MODELO / MODÈLE / MODELO / MODEL CÓDIGO / CODE / CÓDIGO / CODE		GM 2800.526	GM 2 2800.528
<b>Preço / Prix / Precio / Price</b>	€	<b>1.199,00</b>	<b>1.819,00</b>
Dimensões / Dimensions / Dimensiones	mm	500x180x350	500x210x350
Capacidade / Capacidad / Capacité / Capacidad / Capacity	lt	-	-
Peso Líquido / Poids Net / Peso Neto / Net Weight	kg	12,85	13,95
Potência / Puissance / Potencia / Power	W	350	350
Tensão / Tension / Tensión / Tension	V	230	230

MODELO / MODÈLE / MODELO / MODEL CÓDIGO / CODE / CÓDIGO / CODE		GM 3 2800.530	GM 4 2800.532
<b>Preço / Prix / Precio / Price</b>	€	<b>2.341,00</b>	<b>2.609,00</b>
Dimensões / Dimensions / Dimensiones	mm	600x320x550	600x320x530
Capacidade / Capacidad / Capacité / Capacidad / Capacity	lt	1,5	1,5 + 1,0
Peso Líquido / Poids Net / Peso Neto / Net Weight	kg	18,3	19,7
Potência / Puissance / Potencia / Power	W	800	700
Tensão / Tension / Tensión / Tension	V	230	230

**DIHR**

**FRAPPÉS PARA COCKTAILS E BATIDOS**  
**FRAPPÉS POUR COCKTAIL ET MILKSHAKE**  
**FRAPPÉS PARA COCKTAILS Y BATIDOS**  
**FRAPPÉS FOR COCKTAILS AND MILKSHAKES**



Batedores, misturadores com "frappé" ideais para fazer milk-shakes, maionese. Estes modelos podem ser de bancada ou para fixar à parede, e os copos podem ser em policarbonato ou aço inox. M1V/M2 V - C/ variação de velocidade



Batteur milk-shake pour monter des milk-shake ou des crèmes fouettés. Il y a des modèles pour le comptoir ou des modèles pour accrocher au mur et les verres peuvent être en polycarbonate ou en acier inoxydable. M1V/M2 V - Avec variateur de vitesse



Batidoras, para la preparación de milk-shakes, cremas. Estos modelos pueden ser de sobremesa o para calgar en la pared, y las vasos pueden ser en policarbonato o acero inoxidable. M1V/M2 V - Con velocidad variable



Frappe blenders suitable for whipping milkshakes or cream. Counter or wall-mounted models available, with polycarbonate or stainless steel jugs. M1V/M2 V - With variable speed motor





MODELO / MODÈLE / MODELO / MODEL CÓDIGO / CODE / CÓDIGO / CODE		M1 2800.502	M1 V 2800.504
<b>Preço / Prix / Precio / Price</b>	<b>€</b>	<b>391,00</b>	<b>494,00</b>
Dimensões / Dimensions / Dimensiones	mm	180x220x500	180x220x500
Capacidade / Capacité / Capacidad / Capacity	lt	1	1
Rotações / Rotations / Rotaciones / Rotations	rpm	-	-
Peso Líquido / Poids Net / Peso Neto / Net Weight	kg	5	5
Potência / Puissance / Potencia / Power	w	150	150
Tensão / Tension / Tensión / Tension	v	230	230





MODELO / MODÈLE / MODELO / MODEL CÓDIGO / CODE / CÓDIGO / CODE		M2 2800.506	M2V 2800.508
<b>Preço / Prix / Precio / Price</b>	<b>€</b>	<b>689,00</b>	<b>859,00</b>
Dimensões / Dimensions / Dimensiones	mm	310x220x500	310x220x500
Capacidade / Capacité / Capacidad / Capacity	lt	1 + 1	1 + 1
Rotações / Rotations / Rotaciones / Rotations	rpm	-	-
Peso Líquido / Poids Net / Peso Neto / Net Weight	kg	8,3	8,3
Potência / Puissance / Potencia / Power	w	300	300
Tensão / Tension / Tensión / Tension	v	230	230

**V = Variador de velocidade / Variateur de vitesse / Variador de velocidade / Speed variator**

 ARTIC DELUXE - Carroçaria em aço inox; Compressor hermético; Linhas compactas e estéticas; Condensador de ventilação de ar forçado; Reservatório desmontável para uma perfeita limpeza.

 ARTIC DELUXE - Chassis en acier inoxydable; Compresseur hermétique; Lignes compactes et esthétiques; Condenseur à refroidissement par air forcé; Réservoir démontable pour un parfait nettoyage.

 ARTIC DELUXE - Estructura en acero inoxidable; Compressor hermético; Líneas compactas y estéticas; Condensador de ventilación forzada; Depósito desmontable para una perfecta limpieza.

 ARTIC DELUXE - Stainless steel body; Hermetically sealed compressor. Compact and esthetic lines; Air cooled condenser. Deposit system easy to remove for perfect cleaning.



**A**



**P**

**A = Agitador / Agitateur / Agitador / Stirring paddle**

**P = Com efeito fonte / Avec effet de fontaine / Con efecto fuente / With springs effect**



MODELO / MODÈLE / MODELO / MODEL	12/1 A	20/1-A
CÓDIGO / CODE / CÓDIGO / CODE	2016.191	2016.195
MODELO / MODÈLE / MODELO / MODEL	12/1 P	20/1 P
CÓDIGO / CODE / CÓDIGO / CODE	2016.180	2016.185
<b>Preço / Prix / Precio / Price</b>	<b>€ 939,00</b>	<b>1.089,00</b>
Dimensões / Dimensions / Dimensiones	mm 180x 470x 570	180x 470x 670
Capacidade / Capacité / Capacidad / Capacity	lt 1x12	20
Peso Líquido-Bruto / Poids Net-Brut / Peso Neto-Bruto / Net-Gross Weight	kg 17-19	18-20
Potência / Puissance / Potencia / Power	w 270	270
Tensão / Tension / Tensión / Tension	v 230	230



MODELO / MODÈLE / MODELO / MODEL	12/2 A	20/2-A
CÓDIGO / CODE / CÓDIGO / CODE	2016.192	2016.196
MODELO / MODÈLE / MODELO / MODEL	12/2 P	20/2 P
CÓDIGO / CODE / CÓDIGO / CODE	2016.182	2016.186
<b>Preço / Prix / Precio / Price</b>	<b>€ 1.390,00</b>	<b>1.580,00</b>
Dimensões / Dimensions / Dimensiones	mm 360x 470x 570	360x 470x 670
Capacidade / Capacité / Capacidad / Capacity	lt 2x12	2x20
Peso Líquido-Bruto / Poids Net-Brut / Peso Neto-Bruto / Net-Gross Weight	kg 23-26	26-29
Potência / Puissance / Potencia / Power	w 650	650
Tensão / Tension / Tensión / Tension	v 230	230



MODELO / MODÈLE / MODELO / MODEL	12/3 A	20/3-A
CÓDIGO / CODE / CÓDIGO / CODE	2016.193	2016.197
MODELO / MODÈLE / MODELO / MODEL	12/3 P	20/3 P
CÓDIGO / CODE / CÓDIGO / CODE	2016.183	2016.187
<b>Preço / Prix / Precio / Price</b>	<b>€ 1.856,00</b>	<b>2.150,00</b>
Dimensões / Dimensions / Dimensiones	mm 540x 470x 570	540x 470x 670
Capacidade / Capacité / Capacidad / Capacity	lt 3x12	3x20
Peso Líquido-Bruto / Poids Net-Brut / Peso Neto-Bruto / Net-Gross Weight	kg 37-40	42-45
Potência / Puissance / Potencia / Power	w 650	650
Tensão / Tension / Tensión / Tension	v 230	230



MODELO / MODÈLE / MODELO / MODEL	12/4 P	20/4-A
CÓDIGO / CODE / CÓDIGO / CODE	2016.184	2016.198
<b>Preço / Prix / Precio / Price</b>	<b>€ 2.436,00</b>	<b>2.708,00</b>
Dimensões / Dimensions / Dimensiones	mm 720x 470x 570	720x 470x 670
Capacidade / Capacité / Capacidad / Capacity	lt 4x12	4x20
Peso Líquido-Bruto / Poids Net-Brut / Peso Neto-Bruto / Net-Gross Weight	kg 50-55	53-56
Potência / Puissance / Potencia / Power	w 1 050	1 050
Tensão / Tension / Tensión / Tension	v 230	230



**ugolini**  
made in Italy

**MÁQUINAS DE SUMOS**  
MACHINES À JUS  
MÁQUINAS DE ZUMO  
JUICE MACHINES



MOD. COMPACT - Fáceis de usar e versáteis, estes distribuidores são idealizados para arrefecer todos os tipos de bebidas não gaseificadas, usando uma bomba submersa magnética. Rapidamente e facilmente desmontáveis para uma limpeza perfeita. Cubas em policarbonato alimentar à prova de choque.



MOD. COMPACT - Distributeurs faciles à utiliser et adaptable, ils sont conçus pour refroidir les boissons non gazeuses grâce à une pompe submergée à entraînement magnétique. Rapidement et facilement démontables, ils sont parfaitement nettoyables. Bacs incassables en polycarbonate alimentaire.



MOD. COMPACT - Se trata de distribuidores fáciles de utilizar y versátiles que se han diseñado para enfriar, mediante la bomba sumergida de accionamiento magnético, cualquier tipo de bebida sin gas. Se desmontan de forma rápida y fácil, permiten una limpieza perfecta, ahorrando tiempo y simplificando y rentabilizando su trabajo. Recipientes en policarbonato irrompible para alimentos.



MOD. COMPACT - Easy to use and versatile, these dispensers are designed to cool all types of non-carbonated drinks using a magnetic submerged pump. Quick and easy to dismantle for perfect cleaning. Shockproof polycarbonate food grade bowls.



**\*Termostato eletrónico**

Thermostat électronique  
Termostato electrónico  
Electronic thermostat

MODELO / MODÈLE / MODELO / MODEL CÓDIGO / CODE / CÓDIGO / CODE		A19 2016.075	A19 2016.077*
Preço/ Prix / Precio / Price	€	1.344,00 €	1.543,00
Dimensões / Dimensions / Dimensiones	mm	320x400x700	320x400x700
Capacidade / Capacité / Capacidad / Capacity	lt	19	19
Peso Líquido-Bruto / Poids Net-Brut / Peso Neto-Bruto / Net-Gross Weight	kg	20-22	20-22
Termostato electrónico / Thermostat électronique / Termostato electrónico / Electronic thermostat	S/N	N	S
Potência / Puissance / Potencia / Power	w	300	300
Tensão / Tension / Tensión / Tension	v	230	230



**COMPACT**



**Com bomba submersa**

Avec bombe submergée  
Con la bomba sumergida  
With submerged pompe



MODELO / MODÈLE / MODELO / MODEL CÓDIGO / CODE / CÓDIGO / CODE		COMPACT 1X8 2016.120	COMPACT 2X8 2016.125	COMPACT 3X8 2016.130	COMPACT 4X8 2016.135
Preço/ Prix / Precio / Price	€	779,00	1.021,00	1.359,00	1.614,00
Dimensões / Dimensions / Dimensiones	mm	180x 400x 630	250x 400x 630	370x 400x 630	500x 400x 630
Capacidade / Capacité / Capacidad / Capacity	lt	1x8	2x8	3x8	4x8
Peso Líquido-Bruto / Poids Net-Brut / Peso Neto-Bruto / Net-Gross Weight	kg	14-15	17-19	22-24	29-30
Potência / Puissance / Potencia / Power	w	170	300	315	410
Tensio / Tension / Tensión / Tension	v	230	230	230	230



confirmar disponibilidade  
confirmer la disponibilité  
confirmar la disponibilidad  
confirm the availability



MODELO / MODÈLE / MODELO / MODEL	HT20/1
CÓDIGO / CODE / CÓDIGO / CODE	2016.011
<b>Preço / Prix / Precio / Price</b>	<b>€ 838,00</b>
Dimensões / Dimensions / Dimensiones	mm 180x470x690
Capacidade / Capacidad / Capacité / Capacidad / Capacity	lt 20
Peso Líquido-Bruto / Poids Net-Brut / Peso Neto-Bruto / Net-Gross Weight	kg 22-25
Potência / Puissance / Potencia / Power	W -
Tensão / Tension / Tensión / Tension	V 230



MODELO / MODÈLE / MODELO / MODEL	HT20/4
CÓDIGO / CODE / CÓDIGO / CODE	2016.014
<b>Preço / Prix / Precio / Price</b>	<b>€ 2.187,00</b>
Dimensões / Dimensions / Dimensiones	mm 720x470x690
Capacidade / Capacidad / Capacité / Capacidad / Capacity	lt 4x20
Peso Líquido-Bruto / Poids Net-Brut / Peso Neto-Bruto / Net-Gross Weight	kg 55-59
Potência / Puissance / Potencia / Power	W -
Tensão / Tension / Tensión / Tension	V 230



MODELO / MODÈLE / MODELO / MODEL	HT10/1A1
CÓDIGO / CODE / CÓDIGO / CODE	2016.018
<b>Preço / Prix / Precio / Price</b>	<b>€ 844,00</b>
Dimensões / Dimensions / Dimensiones	mm 180x470x690
Capacidade / Capacidad / Capacité / Capacidad / Capacity	lt 10
Peso Líquido-Bruto / Poids Net-Brut / Peso Neto-Bruto / Net-Gross Weight	kg 20-23
Potência / Puissance / Potencia / Power	W -
Tensão / Tension / Tensión / Tension	V 230



MODELO / MODÈLE / MODELO / MODEL	ARTIC COMPACT 4X8
CÓDIGO / CODE / CÓDIGO / CODE	2016.135
<b>Preço / Prix / Precio / Price</b>	<b>€ 1.614,00</b>
Dimensões / Dimensions / Dimensiones	mm 500x400x630
Capacidade / Capacidad / Capacité / Capacidad / Capacity	lt 4x8
Peso Líquido-Bruto / Poids Net-Brut / Peso Neto-Bruto / Net-Gross Weight	kg 29-30
Potência / Puissance / Potencia / Power	W 410
Tensão / Tension / Tensión / Tension	V 230



MODELO / MODÈLE / MODELO / MODEL	ARTIC COMPACT 4/12
CÓDIGO / CODE / CÓDIGO / CODE	2016.155
<b>Preço / Prix / Precio / Price</b>	<b>€ 1.628,00</b>
Dimensões / Dimensions / Dimensiones	mm 720x466x612
Capacidade / Capacidad / Capacité / Capacidad / Capacity	lt 4x12
Peso Bruto / Poids Brut / Peso Bruto / Gross Weight	kg 44
Potência / Puissance / Potencia / Power	W -
Tensão / Tension / Tensión / Tension	V 230



MODELO / MODÈLE / MODELO / MODEL	ARTIC COMPACT 1/20
CÓDIGO / CODE / CÓDIGO / CODE	2016.160
<b>Preço / Prix / Precio / Price</b>	<b>€ 745,00</b>
Dimensões / Dimensions / Dimensiones	mm 180x470x712
Capacidade / Capacidad / Capacité / Capacidad / Capacity	lt 20
Peso Bruto / Poids Brut / Peso Bruto / Gross Weight	kg 20
Potência / Puissance / Potencia / Power	W 410
Tensão / Tension / Tensión / Tension	V 230





**ugolini**  
made in Italy

## DISTRIBUIDORES DE CREMES, BEBIDAS E GRANIZADOS

DISTRIBUTEUR DE CRÈMES, BOISSONS ET GRANITÉS

DISTRIBUIDOR DE CREMAS, BEBIDAS Y GRANIZADOS

DISTRIBUTOR FOR CREAMS, DRINKS AND GRANITAS



MT - Corpo em aço inox com depósito em policarbonato atóxico resistente, com capacidade de 10 L. Sistema de agitação magnético, compressor hermético e condensador com ventilação forçada. MICRO - Especialmente desenhado para uma melhor preparação de cremes frios e uma recolha de condensado mais fácil.



MT - Corps en acier inoxydable, avec réservoir en polycarbonate infrangible non toxique, avec capacité de 10 L. Système de mélange magnétique, compresseur hermétique et condenseur à refroidissement par air forcé. MICRO - Spécialement conçu pour une meilleure préparation des crèmes froides et une collecte de condensat plus facile.



MT - Cuerpo en acero inox con depósito en policarbonato atóxico irrompible, con capacidad de 10 L. Sistema de agitación magnético, compresor hermético, condensador con ventilación forzada. MICRO - Especialmente diseñado para una mejor preparación de cremas frías y una recogida de condensado más fácil.



MT - Stainless steel body with shock-proof, non-toxic polycarbonate container, with 10 L capacity. Mixing system by magnetic transmission, hermetically sealed compressor, air cooled condenser. MICRO - Specially designed for better preparation of cold creams and easier collection of condensate.



MODELO / MODÈLE / MODELO / MODEL	MICRO	
CÓDIGO / CODE / CÓDIGO / CODE	2016.234	
Preço / Prix / Precio / Price	€	1.268,00
Dimensões / Dimensions / Dimensiones	mm	180x470x510
Capacidade / Capacidad / Capacité / Capacidad / Capacity	lt	3
Peso Líquido-Bruto / Poids Net-Brut / Peso Neto-Bruto / Net-Gross Weight	kg	20-22
Potência / Puissance / Potencia / Power	w	460
Tensão / Tension / Tensión / Tension	v	230



MODELO / MODÈLE / MODELO / MODEL	MT 1 P	
CÓDIGO / CODE / CÓDIGO / CODE	2016.320	
Preço / Prix / Precio / Price	€	2.120,00
Dimensões / Dimensions / Dimensiones	mm	280x470x690
Capacidade / Capacidad / Capacité / Capacidad / Capacity	lt	10
Peso Líquido-Bruto / Poids Net-Brut / Peso Neto-Bruto / Net-Gross Weight	kg	25-28
Potência / Puissance / Potencia / Power	w	460
Tensão / Tension / Tensión / Tension	v	230



MODELO / MODÈLE / MODELO / MODEL	MT 2	
CÓDIGO / CODE / CÓDIGO / CODE	2016.326	
Preço / Prix / Precio / Price	€	3.528,00
Dimensões / Dimensions / Dimensiones	mm	360x470x690
Capacidade / Capacidad / Capacité / Capacidad / Capacity	lt	2x10
Peso Líquido-Bruto / Poids Net-Brut / Peso Neto-Bruto / Net-Gross Weight	kg	39-42
Potência / Puissance / Potencia / Power	w	1100
Tensão / Tension / Tensión / Tension	v	230



MODELO / MODÈLE / MODELO / MODEL	GIANT 2	
CÓDIGO / CODE / CÓDIGO / CODE	2016.338	
Preço / Prix / Precio / Price	€	4.611,00
Dimensões / Dimensions / Dimensiones	mm	460x530x900
Capacidade / Capacidad / Capacité / Capacidad / Capacity	lt	2x15
Peso Líquido-Bruto / Poids Net-Brut / Peso Neto-Bruto / Net-Gross Weight	kg	61-66
Potência / Puissance / Potencia / Power	w	1600
Tensão / Tension / Tensión / Tension	v	230



MODELO / MODÈLE / MODELO / MODEL	MT 3	
CÓDIGO / CODE / CÓDIGO / CODE	2016.332	
Preço / Prix / Precio / Price	€	4.985,00
Dimensões / Dimensions / Dimensiones	mm	540x470x690
Capacidade / Capacidad / Capacité / Capacidad / Capacity	lt	3x10
Peso Líquido-Bruto / Poids Net-Brut / Peso Neto-Bruto / Net-Gross Weight	kg	53-56
Potência / Puissance / Potencia / Power	w	1300
Tensão / Tension / Tensión / Tension	v	230



bancada  
plain de travail  
encimera  
worktop



confirmar disponibilidade  
confirmer la disponibilité  
confirmar la disponibilidad  
confirm the availability



Desenho otimizado melhor conservação  
 Painel removível  
 Facilitador de limpeza  
 Novo software  
 Melhor gestão do produto | função temporização de funcionamento  
 Apresente ao seu cliente uma nova geração de sabores excepcionais de gelados e granizados!



Conception optimisée pour une meilleure conservation  
 Panneau amovible: facilitateur nettoyage  
 Nouveau logiciel: mieux gestion des produits | opération de fonction de chronométrage  
 Présentez votre client une nouvelle génération de saveurs exceptionnelles de crème glacée et granités!



Diseño optimizado para mejor conservación  
 Panel desmontable: facilitador de limpieza  
 Nuevo software: mejor gestión de productos | operación de la función de temporización  
 Presente su cliente una nueva generación de sabores excepcionales de helados y granizados!



Optimized design better conservation  
 Removable panel: cleaning facilitator  
 New software: better product management | timing function operation  
 Present your client a new generation of exceptional flavors of ice cream and slush!



Fechadura opcional  
 Serrure en option  
 Bloqueo opcional  
 Optional Lock

**PAINEL RETRO-ILUMINADO COM TECNOLOGIA LED**

LED backlit display

Pantalla retro-iluminada con tecnologia LED

Ecran rétro-éclairé avec technologie LED



MODELO / MODÈLE / MODELO / MODEL	NG 6-1	
CÓDIGO / CODE / CÓDIGO / CODE	2016.340	
<b>Preço / Prix / Precio / Price</b>	€	<b>2.288,00</b>
Dimensões / Dimensions / Dimensiones	mm	195x480x615
Peso Líquido / Poids Net / Peso Neto / Net Weight	kg	23
Peso Bruto / Poids Brut / Peso Bruto / Gross Weight	kg	25
Cuba / Cuve / Cuba / Container	n	1
Capacidade / Capacité / Capacidad / Capacity	l	6
Tensão / Tension / Tensión / Tension	V	230



MODELO / MODÈLE / MODELO / MODEL	NG 6-2	
CÓDIGO / CODE / CÓDIGO / CODE	2016.342	
<b>Preço / Prix / Precio / Price</b>	€	<b>3.632,00</b>
Dimensões / Dimensions / Dimensiones	mm	395x480x615
Peso Líquido / Poids Net / Peso Neto / Net Weight	kg	41
Peso Bruto / Poids Brut / Peso Bruto / Gross Weight	kg	44
Cuba / Cuve / Cuba / Container	n	2
Capacidade / Capacité / Capacidad / Capacity	l	2x6
Tensão / Tension / Tensión / Tension	V	230



MODELO / MODÈLE / MODELO / MODEL	NG 6-3	
CÓDIGO / CODE / CÓDIGO / CODE	2016.344	
<b>Preço / Prix / Precio / Price</b>	€	<b>5.378,00</b>
Dimensões / Dimensions / Dimensiones	mm	595x480x615
Peso Líquido / Poids Net / Peso Neto / Net Weight	kg	57
Peso Bruto / Poids Brut / Peso Bruto / Gross Weight	kg	60
Cuba / Cuve / Cuba / Container	n	3
Capacidade / Capacité / Capacidad / Capacity	l	3x6
Tensão / Tension / Tensión / Tension	V	230





**ugolini**  
made in Italy

**MÁQUINAS DE GRANIZADO E GELADO**  
MACHINES À GRANITÉ ET GLACÉE  
MAQUINAS DE GRANIZADO Y HELADOS  
GRANITAS MACHINES AND ICE-CREAM



MODELO / MODÈLE / MODELO / MODEL	NG 10-1	
CÓDIGO / CODE / CÓDIGO / CODE	2016.346	
<b>Preço / Prix / Precio / Price</b>	€	<b>2.390,00</b>
Dimensões / Dimensions / Dimensiones	mm	195x500x705
Peso Líquido / Poids Net / Peso Neto / Net Weight	kg	25
Peso Bruto / Poids Brut / Peso Bruto / Gross Weight	kg	27
Cuba / Cuve / Cuba / Container	n	1
Capacidade 1 Cuba / Capacité 1 Cuve / Capacidad 1 Cuba / Capacity for 1 Container	l	10
Tensão / Tension / Tensión / Tension	V	230



MODELO / MODÈLE / MODELO / MODEL	NG 10-2	
CÓDIGO / CODE / CÓDIGO / CODE	2016.348	
<b>Preço / Prix / Precio / Price</b>	€	<b>4.013,00</b>
Dimensões / Dimensions / Dimensiones	mm	395x500x705
Peso Líquido / Poids Net / Peso Neto / Net Weight	kg	45
Peso Bruto / Poids Brut / Peso Bruto / Gross Weight	kg	48
Cuba / Cuve / Cuba / Container	n	2
Capacidade 1 Cuba / Capacité 1 Cuve / Capacidad 1 Cuba / Capacity for 1 Container	l	2x10
Tensão / Tension / Tensión / Tension	V	230



MODELO / MODÈLE / MODELO / MODEL	NG 10-3	
CÓDIGO / CODE / CÓDIGO / CODE	2016.350	
<b>Preço / Prix / Precio / Price</b>	€	<b>5.783,00</b>
Dimensões / Dimensions / Dimensiones	mm	595x500x705
Peso Líquido / Poids Net / Peso Neto / Net Weight	kg	61
Peso Bruto / Poids Brut / Peso Bruto / Gross Weight	kg	64
Cuba / Cuve / Cuba / Container	n	3
Capacidade 1 Cuba / Capacité 1 Cuve / Capacidad 1 Cuba / Capacity for 1 Container	l	3x10
Tensão / Tension / Tensión / Tension	V	230





Máquina com carroçaria em aço pintado; Tanque de copoliéster (BPA - Free); Compressor hermético; Condensador refrigerado a ar; Proteção do motor; Filtro do condensador. O estilo único e moderno aliado ao seu tamanho extremamente reduzido permitem a adaptação em qualquer ambiente. Excelente para a preparação de cremes frios, sorvetes e granizados; Foi desenhado para recipiente de 2,8 litros que permite gerenciar pequenas quantidades de produto evitando desperdícios desnecessários. Modelos L com iluminação LED.



Machine avec carrosserie en acier peint; Réservoir en copolyester (BPA - Free); Compresseur hermétique; Condenseur refroidi par air; Protection moteur; Filtre condenseur. Le style unique et moderne combiné à sa taille extrêmement petite lui permet de s'adapter à n'importe quel environnement. Excellent pour la préparation de crèmes froides, glaces et barbotines. Il a été conçu pour un récipient de 2,8 litres, ce qui vous permet de gérer de petites quantités de produit, en évitant les déchets inutiles. Modèles L avec éclairage LED.



Máquina com carroçaria de acero pintado; Depósito de copoliéster (BPA - Free); Compresor hermético; Condensador enfriado por aire; Protección del motor; Filtro condensador. El estilo único y moderno combinado con su tamaño extremadamente pequeño permite adaptarse a cualquier entorno. Excelente para la preparación de cremas frías, helados y granizados. Fue diseñado para envase de 2,8 litros, lo que permite manejar pequeñas cantidades de producto, evitando desperdicios innecesarios. Modelos L con iluminación LED.



Machine with painted steel bodywork; Copolyester tank (BPA - Free); Hermetic compressor; Air-cooled condenser; Overload protector; Condenser filter. The unique and modern style combined with its extremely small size allows it to adapt to any environment. Excellent for the preparation of cold creams, ice creams and slushes. It was designed for a 2,8 liter container, which allows you to manage small amounts of product, avoiding unnecessary waste. L models with LED lighting.



**NOVO  
NOUVEAU  
NUEVO  
NEW**



MODELO / MODÈLE / MODELO / MODEL	ICON 1	ICON 1L
CÓDIGO / CODE / CÓDIGO / CODE	2016.250	2016.255
<b>Preço / Prix / Precio / Price</b>	<b>€ 1.451,00</b>	<b>1.503,00</b>
Dimensões / Dimensions / Dimensiones	mm 180x440x490	180x440x490
Capacidade cuba / Cap cuve / Cap. cuba / Vat capacity	Lt 2,8	2,8
Termostato Regulável / Thermostat réglable / Termostato Ajustable / Adjustable Thermostat	nr 1	1
Gás refrigerante / Gaz réfrigérant / Gas refrigerante / Coolant Gas	R290	R290
Peso Líquido-Bruto / Poids Net-Brut / Peso Neto-Bruto / Net-Gross Weight	kg 20-22	20-22
Potência / Puissance / Potência / Power	kW 0,46	0,46
Tensão / Tension / Tensión / Tension	V 230	230

**NOVO  
NOUVEAU  
NUEVO  
NEW**



MODELO / MODÈLE / MODELO / MODEL	ICON 2	ICON 2L
CÓDIGO / CODE / CÓDIGO / CODE	2016.260	2016.265
<b>Preço / Prix / Precio / Price</b>	<b>€ 2.764,00</b>	<b>2.844,00</b>
Dimensões / Dimensions / Dimensiones	mm 370x440x490	370x440x490
Capacidade cuba / Cap cuve / Cap. cuba / Vat capacity	Lt 2,8+2,8	2,8+2,8
Termostato Regulável / Thermostat réglable / Termostato Ajustable / Adjustable Thermostat	nr 2	2
Gás refrigerante / Gaz réfrigérant / Gas refrigerante / Coolant Gas	R290	R290
Peso Líquido-Bruto / Poids Net-Brut / Peso Neto-Bruto / Net-Gross Weight	kg 36-38	36-38
Potência / Puissance / Potência / Power	kW 1,1	1,1
Tensão / Tension / Tensión / Tension	V 230	230

**NOVO  
NOUVEAU  
NUEVO  
NEW**



MODELO / MODÈLE / MODELO / MODEL	ICON 3	ICON 3L
CÓDIGO / CODE / CÓDIGO / CODE	2016.270	2016.275
<b>Preço / Prix / Precio / Price</b>	<b>€ 3.700,00</b>	<b>3.816,00</b>
Dimensões / Dimensions / Dimensiones	mm 550x440x490	550x440x490
Capacidade cuba / Cap cuve / Cap. cuba / Vat capacity	Lt 2,8+2,8+2,8	2,8+2,8+2,8
Termostato Regulável / Thermostat réglable / Termostato Ajustable / Adjustable Thermostat	nr 3	3
Gás refrigerante / Gaz réfrigérant / Gas refrigerante / Coolant Gas	R290	R290
Peso Líquido-Bruto / Poids Net-Brut / Peso Neto-Bruto / Net-Gross Weight	kg 52-54	52-54
Potência / Puissance / Potência / Power	kW 1,3	1,3
Tensão / Tension / Tensión / Tension	V 230	230



UDI

**TORRADEIRAS / TORRADEIRAS DE TAPETE**

TOASTEURS / TOASTEURS À TAPIS

TOSTADORAS / TOSTADORAS DE CINTA

TOASTERS / CONVEYOR TOASTERS

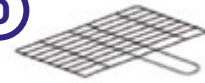
**GRELHA 8050**  
**2800.538****36,00**

MODELO / MODÈLE / MODELO / MODEL	UT 20
CÓDIGO / CODE / CÓDIGO / CODE	3010.090
<b>Preço / Prix / Precio / Price</b>	<b>€ 257,00</b>
Dimensões / Dimensions / Dimensiones	mm 532x290x250
Área de cozedura / Surface de cuisson / Superficie de cocción / Surface de cuisson/ Cooking area	mm 430x240
Temporizador /Timer/ Temporizador /Timer	√
Peso Bruto / Poids Brut / Peso Bruto / Gross Weight	kg 7,1
Potência / Puissance / Potencia / Power	kW 2
Tensão / Tension / Tensión / Tension	v 230



MODELO / MODÈLE / MODELO / MODEL	UT 30
CÓDIGO / CODE / CÓDIGO / CODE	3010.092
<b>Preço / Prix / Precio / Price</b>	<b>€ 310,00</b>
Dimensões / Dimensions / Dimensiones	mm 532x290x365
Área de cozedura / Surface de cuisson / Superficie de cocción / Surface de cuisson/ Cooking area	mm 2x 430x240
Temporizador /Timer/ Temporizador /Timer	√
Peso Bruto / Poids Brut / Peso Bruto / Gross Weight	kg 8
Potência / Puissance / Potencia / Power	kW 3
Tensão / Tension / Tensión / Tension	v 230



MODELO / MODÈLE / MODELO / MODEL	F 60 P
CÓDIGO / CODE / CÓDIGO / CODE	2800.534
<b>Preço / Prix / Precio / Price</b>	<b>€ 470,00</b>
Dimensões / Dimensions / Dimensiones	mm 490x250x230
Área de cozedura / Surface de cuisson / Superficie de cocción / Surface de cuisson/ Cooking area	mm 350x240
Temporizador /Timer/ Temporizador /Timer	√
Peso Bruto / Poids Brut / Peso Bruto / Gross Weight	kg 8,5
Potência / Puissance / Potencia / Power	kW 2
Tensão / Tension / Tensión / Tension	v 230



MODELO / MODÈLE / MODELO / MODEL	F 120 P
CÓDIGO / CODE / CÓDIGO / CODE	2800.536
<b>Preço / Prix / Precio / Price</b>	<b>€ 592,00</b>
Dimensões / Dimensions / Dimensiones	mm 490x250x350
Área de cozedura / Surface de cuisson / Superficie de cocción / Surface de cuisson/ Cooking area	mm 350x240
Temporizador /Timer/ Temporizador /Timer	√
Peso Bruto / Poids Brut / Peso Bruto / Gross Weight	kg -
Potência / Puissance / Potencia / Power	kW 3
Tensão / Tension / Tensión / Tension	v 230



MODELO / MODÈLE / MODELO / MODEL	UTV28
CÓDIGO / CODE / CÓDIGO / CODE	3010.096
<b>Preço / Prix / Precio / Price</b>	<b>€ 1.571,00</b>
Dimensões / Dimensions / Dimensiones	mm 500x560x390
Área de cozedura / Surface de cuisson / Superficie de cocción / Surface de cuisson/ Cooking area	mm 280x75
Temporizador /Timer/ Temporizador /Timer	-
Peso Bruto / Poids Brut / Peso Bruto / Gross Weight	kg 25
Potência / Puissance / Potencia / Power	kW 3
Tensão / Tension / Tensión / Tension	v 230



MODELO / MODÈLE / MODELO / MODEL	UDITC600
CÓDIGO / CODE / CÓDIGO / CODE	5200.120
<b>Preço / Prix / Precio / Price</b>	<b>€ 1.974,00</b>
Dimensões / Dimensions / Dimensiones	mm 478x600x420
Área de cozedura / Surface de cuisson / Superficie de cocción / Surface de cuisson/ Cooking area	mm -
Temporizador /Timer/ Temporizador /Timer	√
Peso Bruto / Poids Brut / Peso Bruto / Gross Weight	kg 35
Potência / Puissance / Potencia / Power	kW 3,5
Tensão / Tension / Tensión / Tension	v 230

opcional  
opcionnel  
opcional  
optional



Com uma fonte de calor na parte superior, a salamandra permite descongelar, dourar, glacear, gratinar, tostar todo o tipo de pratos em grande quantidade, sem preaquecimento.



Avec une source de chaleur en partie supérieur, la salamandre permet de décongeler, dorer, glacer, gratiner, griller tout le type de plats en grande quantité, sans préchauffage.



Con una fonte de calor en la parte superior, la salamandra permite descongelar, dorar, glacer, gratinar, tostar todo lo tipo de platos en grande cantidad, sin precalentamiento.



With a heat source on the upper part, the salamander can be used to defrost, brown, glaze, grill toasts, gratins all kind of plates in larges quantities, without pre-heating.



MODELO / MODÈLE / MODELO / MODEL	SA/E 48
CÓDIGO / CODE / CÓDIGO / CODE	2083.096
<b>Preço / Prix / Precio / Price</b>	<b>€ 860,00</b>
Dimensões / Dimensions / Dimensiones	mm 460x460x440
Área de trabalho / Area de travail / Area de trabajo / Working area	mm -
Fixa / Fixe / Fija / Fixed	√
Peso Bruto / Poids Brut / Peso Bruto / Gross Weight	kg 18
Potência / Puissance / Potencia / Power	kW 2,8
Tensão / Tension / Tensión / Tension	V 230



MODELO / MODÈLE / MODELO / MODEL	CSE-048
CÓDIGO / CODE / CÓDIGO / CODE	2125.500
<b>Preço / Prix / Precio / Price</b>	<b>€ 1.009,00</b>
Dimensões / Dimensions / Dimensiones	mm 455X340X390
Área de trabalho / Area de travail / Area de trabajo / Working area	mm -
Fixa / Fixe / Fija / Fixed	√
Peso Bruto / Poids Brut / Peso Bruto / Gross Weight	kg 21
Potência / Puissance / Potencia / Power	kW 3,1
Tensão / Tension / Tensión / Tension	V 230



MODELO / MODÈLE / MODELO / MODEL	CSE-053
CÓDIGO / CODE / CÓDIGO / CODE	2125.506
<b>Preço / Prix / Precio / Price</b>	<b>€ 2.064,00</b>
Dimensões / Dimensions / Dimensiones	mm 530X380X530
Área de trabalho / Area de travail / Area de trabajo / Working area	mm 380X220
Fixa / Fixe / Fija / Fixed	√
Peso Bruto / Poids Brut / Peso Bruto / Gross Weight	kg 34
Potência / Puissance / Potencia / Power	kW 3,7
Tensão / Tension / Tensión / Tension	V 400



MODELO / MODÈLE / MODELO / MODEL	SEF 80 FIXA
CÓDIGO / CODE / CÓDIGO / CODE	2230.010
<b>Preço / Prix / Precio / Price</b>	<b>€ 1.467,00</b>
Dimensões / Dimensions / Dimensiones	mm 800X505X545
Área de trabalho / Area de travail / Area de trabajo / Working area	mm 740X375
Fixa / Fixe / Fija / Fixed	√
Peso Bruto / Poids Brut / Peso Bruto / Gross Weight	kg 37
Potência / Puissance / Potencia / Power	kW 4,4
Tensão / Tension / Tensión / Tension	V 400



MODELO / MODÈLE / MODELO / MODEL	SGF 80- GÁS
CÓDIGO / CODE / CÓDIGO / CODE	2230.032
<b>Preço / Prix / Precio / Price</b>	<b>€ 2.628,00</b>
Dimensões / Dimensions / Dimensiones	mm 800X590X590
Área de trabalho / Area de travail / Area de trabajo / Working area	mm 740x375
Fixa / Fixe / Fija / Fixed	√
Consumo G20 (Gás Natural)/Consumation G20 (Gaz Naturel)/ ConsumoG20 (Gas Natural) /Consumption G20 (Natural Gas)	m3/h 0,77
Consumo GPL 30-31 / Consommation GPL 30-31 / Consumo GPL 30-31 / Consumption GPL 30-31	kg/h 0,30
Peso Bruto / Poids Brut / Peso Bruto / Gross Weight	kg 40
Potência / Puissance / Potencia / Power	kW 8,1
Tensão / Tension / Tensión / Tension	V -





UDI

**SALAMANDRAS ELÉTRICAS / GÁS**  
SALAMANDRES ÉLECTRIQUES / GAZ  
SALAMANDRAS ELÉTRICAS / GAS  
ELECTRICAL SALAMANDERS / GAS



Construção em aço inox;  
Grelha amovível com pegas;  
Tabuleiro aparador de migalhas;  
Regulador de potência.



Construction en acier inox;  
Grille amovible avec poignées;  
Tiroir ramasse déchets en acier inox;  
Regulateur de puissance.



Construcción en acero inoxidable;  
Parrilla desmontable;  
Cajón recoge migas;  
Regulador de potencia.



Stainless steel construction;  
Removable grid with handles;  
Stainless steel tray;  
Power regulation.



MODELO / MODÈLE / MODELO / MODEL CÓDIGO / CODE / CÓDIGO / CODE		USL45 3010.102	USL45I 3010.104
<b>Preço / Prix / Precio / Price</b>	€	<b>374,00</b>	<b>472,00</b>
Dimensões / Dimensions / Dimensiones	mm	600x300x360	600x360x360
Área de trabalho / Area de travail / Area de trabajo / Working area	mm	450x300x200	450x350x205
Amovível / Amovibles / Amovible / Movable		x	x
Fixa / Fixe / Fija / Fixed		√	√
Peso Bruto / Poids Brut / Peso Bruto / Gross Weight	kg	14	15
Potência / Puissance / Potencia / Power	kW	2,25	3,5
Tensão / Tension / Tensión / Tension	v	230	230



MODELO / MODÈLE / MODELO / MODEL CÓDIGO / CODE / CÓDIGO / CODE		USL65I 3010.106
<b>Preço / Prix / Precio / Price</b>	€	<b>639,00</b>
Dimensões / Dimensions / Dimensiones	mm	800x360x360
Área de trabalho / Area de travail / Area de trabajo / Working area	mm	650x350x205
Amovível / Amovibles / Amovible / Movable		x
Fixa / Fixe / Fija / Fixed		√
Peso Bruto / Poids Brut / Peso Bruto / Gross Weight	kg	18
Potência / Puissance / Potencia / Power	kW	4,5
Tensão / Tension / Tensión / Tension	v	230



MODELO / MODÈLE / MODELO / MODEL CÓDIGO / CODE / CÓDIGO / CODE		SGM 60 2230.031
<b>Preço / Prix / Precio / Price</b>	€	<b>3.397,00</b>
Dimensões / Dimensions / Dimensiones	mm	600x590x590
Área de trabalho / Area de travail / Area de trabajo / Working area	mm	495x375
Amovível / Amovibles / Amovible / Movable		√
Fixa / Fixe / Fija / Fixed		x
Consumo G20 (Gás Natural)/Consumption G20 (Gaz Naturel)/ ConsumoG20 (Gas Natural) /Consumption G20 (Natural Gas)	m3/h	0,51
Consumo GPL 30/31 / Consumption GPL 30/31 / Consumo GPL 30/31 / Consumption GPL 30/31	kg/h	0,2
Peso Bruto / Poids Brut / Peso Bruto / Gross Weight	kg	49
Potência / Puissance / Potencia / Power	kW	5,3
Tensão / Tension / Tensión / Tension	v	-



MODELO / MODÈLE / MODELO / MODEL CÓDIGO / CODE / CÓDIGO / CODE		SEM 600 VC 2230.462
<b>Preço / Prix / Precio / Price</b>	€	<b>3.392,00</b>
Dimensões / Dimensions / Dimensiones	mm	600x590x590
Área de trabalho / Area de travail / Area de trabajo / Working area	mm	540x375
Amovível / Amovibles / Amovible / Movable		√
Fixa / Fixe / Fija / Fixed		x
Peso Bruto / Poids Brut / Peso Bruto / Gross Weight	kg	56
Potência / Puissance / Potencia / Power	kW	3
Tensão / Tension / Tensión / Tension	v	230



Deteção rápida do prato. Em 9" atinge 400°C e em 15 min. 570°C | Détection rapide de la assiette. En 9" atteint 400°C et après 15 min. 570°C.  
Detección rápida del plato. En 9" alcanza 400°C y después de 15 min. 570°C | Fast plate detection. In 9" reaches 400°C and 570°C in 15 min.



A Waffle é muito apreciada em todo o mundo! As máquinas de gofras foram desenhadas para confeccionar diferentes tipos de massa: massas congeladas, massas pré-cozidas ou massas frescas.



La gaufre, et apprécié à travers le monde! Les gaufriers Roller Grill sont conçus pour des pâtons surgelés, des gaufres surgelées précuites et de la pâte fraîche maison.



Le Waffle es muy apreciado en todo el mundo! La máquina de gofres fueran diseñadas para confeccionar diversas masas: masa congelada, masa precocinada o masa fresca hecha en casa.



Waffle is a snack appreciated by everybody in the world! The waffle irons accept deep-frozen, pre-cooked waffles or home-made batter.



7cm

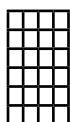

10cm

MODELO / MODÈLE / MODELO / MODEL	SQ S	
CÓDIGO / CODE / CÓDIGO / CODE	2522.880	
<b>Preço / Prix / Precio / Price</b>	<b>€</b>	<b>650,00</b>
Dimensões / Dimensions / Dimensiones	mm	300x320x300
Peso Líquido-Bruto / Poids Net-Brut / Peso Neto-Bruto / Net-Gross Weight	kg	21-23
Potência / Puissance / Potencia / Power	kW	2,2
Tensão / Tension / Tensión / Tension	v	230



MODELO / MODÈLE / MODELO / MODEL	SQ D	
CÓDIGO / CODE / CÓDIGO / CODE	2522.882	
<b>Preço / Prix / Precio / Price</b>	<b>€</b>	<b>1.218,00</b>
Dimensões / Dimensions / Dimensiones	mm	580x320x300
Peso Líquido-Bruto / Poids Net-Brut / Peso Neto-Bruto / Net-Gross Weight	kg	43-54
Potência / Puissance / Potencia / Power	kW	2,2+2,2
Tensão / Tension / Tensión / Tension	v	230



MODELO / MODÈLE / MODELO / MODEL	TREVO	
CÓDIGO / CODE / CÓDIGO / CODE	2522.886	
<b>Preço / Prix / Precio / Price</b>	<b>€</b>	<b>1.182,00</b>
Dimensões / Dimensions / Dimensiones	mm	600x320x300
Peso Líquido-Bruto / Poids Net-Brut / Peso Neto-Bruto / Net-Gross Weight	kg	43-45
Potência / Puissance / Potencia / Power	kW	2,2+2,2
Tensão / Tension / Tensión / Tension	v	230



MODELO / MODÈLE / MODELO / MODEL	GES 20	
CÓDIGO / CODE / CÓDIGO / CODE	2230.308	
<b>Preço / Prix / Precio / Price</b>	<b>€</b>	<b>1.095,00</b>
Dimensões / Dimensions / Dimensiones	mm	305x440x230
Peso Líquido-Bruto / Poids Net-Brut / Peso Neto-Bruto / Net-Gross Weight	kg	19
Potência / Puissance / Potencia / Power	kW	1,6
Tensão / Tension / Tensión / Tension	v	230



UDI



confirmar disponibilidade  
confirmer la disponibilité  
confirmar la disponibilidad  
confirm the availability

MÁQUINAS DE GOFRAS

GAUFRIERS

MÁQUINAS DE GOFRES

WAFFLE IRONS



gás  
gaz  
gas  
gas

MODELO / MODÈLE / MODELO / MODEL CÓDIGO / CODE / CÓDIGO / CODE	GOFRA A GAS G 2 2230.044	
<b>Preço / Prix / Precio / Price</b>	€	<b>1.859,00</b>
Dimensões / Dimensions / Dimensiones	mm	535x500x300
Peso Líquido-Bruto / Poids Net-Brut / Peso Neto-Bruto / Net-Gross Weight	kg	40
Potência / Puissance / Potencia / Power	kW	8,2
Tensão / Tension / Tensión / Tension	V	-



MODELO / MODÈLE / MODELO / MODEL CÓDIGO / CODE / CÓDIGO / CODE	GOFRA EL.DUPL.GED 30 (5 COR.) 2230.312	
<b>Preço / Prix / Precio / Price</b>	€	<b>1.679,00</b>
Dimensões / Dimensions / Dimensiones	mm	550x440x230
Peso Líquido-Bruto / Poids Net-Brut / Peso Neto-Bruto / Net-Gross Weight	kg	38
Potência / Puissance / Potencia / Power	kW	3
Tensão / Tension / Tensión / Tension	V	230



MODELO / MODÈLE / MODELO / MODEL CÓDIGO / CODE / CÓDIGO / CODE	GES 40 2230.310	
<b>Preço / Prix / Precio / Price</b>	€	<b>1.095,00</b>
Dimensões / Dimensions / Dimensiones	mm	305x440x230
Peso Líquido-Bruto / Poids Net-Brut / Peso Neto-Bruto / Net-Gross Weight	kg	19
Potência / Puissance / Potencia / Power	kW	1,6
Tensão / Tension / Tensión / Tension	V	230



MODELO / MODÈLE / MODELO / MODEL CÓDIGO / CODE / CÓDIGO / CODE	GES 70 DIAM. 190MM 2230.315	
<b>Preço / Prix / Precio / Price</b>	€	<b>969,00</b>
Dimensões / Dimensions / Dimensiones	mm	305x440x230
Peso Líquido-Bruto / Poids Net-Brut / Peso Neto-Bruto / Net-Gross Weight	kg	19
Potência / Puissance / Potencia / Power	kW	1,6
Tensão / Tension / Tensión / Tension	V	230



MODELO / MODÈLE / MODELO / MODEL CÓDIGO / CODE / CÓDIGO / CODE	GED 70 DIAM. 190MM 2230.317	
<b>Preço / Prix / Precio / Price</b>	€	<b>1.897,00</b>
Dimensões / Dimensions / Dimensiones	mm	550x440x230
Peso Líquido-Bruto / Poids Net-Brut / Peso Neto-Bruto / Net-Gross Weight	kg	38
Potência / Puissance / Potencia / Power	kW	3,2
Tensão / Tension / Tensión / Tension	V	230





Garantia de uma cozedura homogénea. Resistências em espiral que distribuem uniformemente o calor. Nos modelos a gás, funcionamento com queimadores em estrela.



Garantie d'une cuisson homogène. Résistances en spirale qui distribuent uniformément la chaleur. Dans les modèles à gaz, fonctionnement avec brûleurs en étoile.



Garantía de una cocción homogénea. Resistencias en espiral que distribuyen el calor uniformemente. En los modelos a gas, funcionamiento con quemadores en estrella.



Homogeneous cooking warranty. Spiral elements distribute heat evenly. Gas models function with star burners.



confirmar disponibilidade dos produtos desta página  
confirmer la disponibilité des produits sur cette page  
confirmar la disponibilidad de los productos de esta página  
confirm the availability of the products on this page



MODELO / MODÈLE / MODELO / MODEL	45X50
CÓDIGO / CODE / CÓDIGO / CODE	2522.902
<b>Preço / Prix / Precio / Price</b>	<b>€ 774,00</b>
Dimensões / Dimensions / Dimensiones	mm 450x 500x 220
Diâmetro placa / Diam. de la plaque / Diam. de la placa / Plate diam.	mm 400
Peso Líquido-Bruto / Poids Net-Brut / Peso Neto-Bruto / Net-Gross Weight	kg 20-23
Potência / Puissance / Potencia / Power	kW 3
Tensão / Tension / Tensión / Tension	v 230



MODELO / MODÈLE / MODELO / MODEL	ELT 400X2
CÓDIGO / CODE / CÓDIGO / CODE	2522.904
<b>Preço / Prix / Precio / Price</b>	<b>€ 1.471,00</b>
Dimensões / Dimensions / Dimensiones	mm 900x 500x 220
Diâmetro placa / Diam. de la plaque / Diam. de la placa / Plate diam.	mm 400x2
Peso Líquido-Bruto / Poids Net-Brut / Peso Neto-Bruto / Net-Gross Weight	kg 37-44
Potência / Puissance / Potencia / Power	kW 3+3
Tensão / Tension / Tensión / Tension	v 230



MODELO / MODÈLE / MODELO / MODEL	WI1
CÓDIGO / CODE / CÓDIGO / CODE	2230.456
<b>Preço / Prix / Precio / Price</b>	<b>€ 586,00</b>
Dimensões / Dimensions / Dimensiones	mm 225x 175x 220
Capacidade / Capacité / Capacidad / Capacity	lt 1
Peso Líquido-Bruto / Poids Net-Brut / Peso Neto-Bruto / Net-Gross Weight	kg 2
Potência / Puissance / Potencia / Power	kW 0,17
Tensão / Tension / Tensión / Tension	v 230



MODELO / MODÈLE / MODELO / MODEL	WI2
CÓDIGO / CODE / CÓDIGO / CODE	2230.458
<b>Preço / Prix / Precio / Price</b>	<b>€ 982,00</b>
Dimensões / Dimensions / Dimensiones	mm 330x 215x 230
Capacidade / Capacité / Capacidad / Capacity	lt 1+1
Peso Líquido-Bruto / Poids Net-Brut / Peso Neto-Bruto / Net-Gross Weight	kg 3
Potência / Puissance / Potencia / Power	kW 0,34
Tensão / Tension / Tensión / Tension	v 230





UDI

CREPEIRAS  
CRÊPIÈRES  
CREPERAS  
CREPE MACHINES



confirmar disponibilidade dos produtos desta página  
confirmer la disponibilité des produits sur cette page  
confirmar la disponibilidad de los productos de esta página  
confirm the availability of the products on this page



MODELO / MODÈLE / MODELO / MODEL CÓDIGO / CODE / CÓDIGO / CODE		400FE 2230.011B
<b>Preço / Prix / Precio / Price</b>	€	<b>512,00</b>
Dimensões / Dimensions / Dimensiones	mm	400x160
Díâmetro placa / Diam. de la plaque / Diam. de la placa / Plate diam.	mm	400
Peso Bruto / Poids Brut/ Peso Bruto / Gross Weight	kg	14-15
Potência / Puissance / Potencia / Power	kW	3,6
Tensão / Tension / Tensión / Tension	V	230



MODELO / MODÈLE / MODELO / MODEL CÓDIGO / CODE / CÓDIGO / CODE		BLINIS 406E 2230.330
<b>Preço / Prix / Precio / Price</b>	€	<b>622,00</b>
Dimensões / Dimensions / Dimensiones	mm	400x400x240
Díâmetro placa / Diam. de la plaque / Diam. de la placa / Plate diam.	mm	400
Peso Bruto / Poids Brut/ Peso Bruto / Gross Weight	kg	17,5
Potência / Puissance / Potencia / Power	kW	3,6
Tensão / Tension / Tensión / Tension	V	230



MODELO / MODÈLE / MODELO / MODEL CÓDIGO / CODE / CÓDIGO / CODE		350 E 2230.012	400 E ELET. 2230.012A
<b>Preço / Prix / Precio / Price</b>	€	<b>837,00</b>	<b>911,00</b>
Dimensões / Dimensions / Dimensiones	mm	450x500x240	450x500x240
Díâmetro placa / Diam. de la plaque / Diam. de la placa / Plate diam.	mm	350	400
Peso Bruto / Poids Brut/ Peso Bruto / Gross Weight	kg	14,5	18
Potência / Puissance / Potencia / Power	kW	3	3,6
Tensão / Tension / Tensión / Tension	V	230	230



MODELO / MODÈLE / MODELO / MODEL CÓDIGO / CODE / CÓDIGO / CODE		DUPLA 350 ED 2230.013	400 ED ELET. 2230.013A
<b>Preço / Prix / Precio / Price</b>	€	<b>1.570,00</b>	<b>1.629,00</b>
Dimensões / Dimensions / Dimensiones	mm	860x500x240	860x500x240
Díâmetro placa / Diam. de la plaque / Diam. de la placa / Plate diam.	mm	350x2	400x2
Peso Bruto / Poids Brut/ Peso Bruto / Gross Weight	kg	37	44
Potência / Puissance / Potencia / Power	kW	6	7,2
Tensão / Tension / Tensión / Tension	V	230	230



Máquina de pipocas de bancada, com iluminação, aquecimento na base da cabine. Carro com máquina de pipocas e máquina de algodão doce, panela da máquina de pipocas em aço inox, máquina de algodão em aço inox, sistema de iluminação, carro à prova de água, com recipiente para o açúcar. Máquina de algodão doce com estrutura e panela inoxidáveis, tampa em fibra de vidro e sistema autolimpieza.



Machine à pop corn, avec éclairage, chauffage à la base de l'habitable. Chariot avec machine à pop corn et une machine à barbe à papa, cuiseur machine à pop-corn et machine de coton en acier inoxydable, éclairage, chariot étanche, avec conteneurs pour le sucre. Machine barbe à papa avec structure et casserole en acier inoxydable, couverture en fibre de verre et système de nettoyage automatique.



Máquina de palomitas de maíz, con iluminación, calefacción en la base de la cabina del coche con máquina de palomitas y una máquina de algodón de azúcar, olla de la máquina de palomitas de maíz en acero inoxidable, máquina de algodón de acero inoxidable, sistema de iluminación, carretilla a prueba de agua, con recipiente para el azúcar. Máquina de algodón de azúcar con estructura y olla de acero inoxidable, cubierta en fibra de vidrio e sistema de auto limpieza.



Popcorn machine: with lighting, heating at the base. Popcorn and cotton candy trolley: includes a cotton candy machine, popcorn machine cooker in stainless steel, stainless steel cotton machine, lighting system, water proof trolley, with container for sugar. Cotton candy machine with stainless steel pot and structure, cover in fiberglass and self-cleaning system.



MODELO / MODÈLE / MODELO / MODEL CÓDIGO / CODE / CÓDIGO / CODE	MÁQUINA DE ALGODÃO DOCE UDI 5900.706	
<b>Preço / Prix / Precio / Price</b>	€	<b>6.750,00</b>
Dimensões / Dimensions / Dimensiones	mm	350x600x800
Potência Panela / Puissance Casserole / Potência Cacerola / Pan Power	w	3000
Potência Motor / Puissance Moteur / Potência Motor / Motor Power	w	1000
Tensão / Tension / Tension / Tension	V	230



MODELO / MODÈLE / MODELO / MODEL CÓDIGO / CODE / CÓDIGO / CODE	MÁQUINA DE PIPOCAS UDI 5900.702	
<b>Preço / Prix / Precio / Price</b>	€	<b>4.808,00</b>
Dimensões / Dimensions / Dimensiones	mm	700x450x800
Capacidade Milho / Capacité maïs / Capacidad maíz / Corn capacity	gr	180
Potência Aquecimento / Puissance Chauffage / Potência Calefacción / Heating Power	w	800
Potência Panela / Puissance Casserole / Potência Cacerola / Pan Power	w	1000
Tensão / Tension / Tension / Tension	V	230



MODELO / MODÈLE / MODELO / MODEL CÓDIGO / CODE / CÓDIGO / CODE	CARRO C/ MÁQ. PIPOCAS + MÁQ. ALGODÃO DOCE UDI 5900.704	
<b>Preço / Prix / Precio / Price</b>	€	<b>16.850,00</b>
Dimensões / Dimensions / Dimensiones	mm	1700x800x1650
Capacidade Milho / Capacité maïs / Capacidad maíz / Corn capacity	gr	180
Potência Aquecimento / Puissance Chauffage / Potência Calefacción / Heating Power	w	800
Potência Panela / Puissance Casserole / Potência Cacerola / Pan Power	w	1000+3000
Potência Motor / Puissance Moteur / Potência Motor / Motor Power	w	1000
Tensão / Tension / Tension / Tension	V	230



UDI

VITRINES REFRIGERADAS ELEGANTE

VITRINES RÉFRIGÉRÉES ELEGANTE

VITRINAS REFRIGERADAS ELEGANTE

REFRIGERATED SHOWCASES ELEGANTE



Containers incluidos gn1/6 x 4  
Prateleira intermédia neutra em vidro  
Controlo digital



Bandejas incluidas gn1/6 x 40  
Estante intermedio de cristal  
Control digital



Bacs inclus gn1/6 x 40  
Étagère intermédiaire en verre  
Contrôle numérique



Tray included gn1/6 x 40  
Intermediate glass shelf  
Digital control



MODELO / MODÈLE / MODELO / MODEL CÓDIGO / CODE / CÓDIGO / CODE	SLIM VSL7S LED 3097.502	
<b>Preço / Prix / Precio / Price</b>	€	<b>2.098,00</b>
Dimensões / Dimensions / Dimensiones	mm	1350X260X400
Nº Estantes/Nº Étagere/Nº Estante/ Shelf	nº	1
Medida Estantes/Mesure Étagere/Medida Estante/Shelfs Measure	mm	1075x195
Bandejas/Plateux/Bandeja/Tray	nº	7
Tipo Bandejas/Type Plateux/Tipo Bandejas/Tray type	mm	1/6-40
Leds/Leds/Leds/Leds		Sim
Vidro/Verre/Cristal/Glass		Temperado
Temperatura/Température/Temperatura/Temperature	°C	+2/+6
Potência / Puissance / Potencia / Power	W	90
Tensão / Tension / Tensión / Tension	V	230



Container GN 1/6-40  
Incluído | Inclu | Incluido |  
Included

MODELO / MODÈLE / MODELO / MODEL CÓDIGO / CODE / CÓDIGO / CODE	UDVRE6-VC LED 3097.225A	
<b>Preço / Prix / Precio / Price</b>	€	<b>1.591,00</b>
Dimensões / Dimensions / Dimensiones	mm	1430x240x400
Nº Estantes/Nº Étagere/Nº Estante/ Shelf	nº	1
Medida Estantes/Mesure Étagere/Medida Estante/Shelfs Measure	mm	1075x195
Bandejas/Plateux/Bandeja/Tray	nº	6
Tipo Bandejas/Type Plateux/Tipo Bandejas/Tray type	mm	1/6-40
Leds/Leds/Leds/Leds		Sim
Vidro/Verre/Cristal/Glass		Temperado
Temperatura/Température/Temperatura/Temperature	°C	+2/+6
Potência / Puissance / Potencia / Power	W	-
Tensão / Tension / Tensión / Tension	V	230



confirmar disponibilidade  
confirmer la disponibilité  
confirmar la disponibilidad  
confirm the availability



Sistema de iluminação de última geração Leds luz fria, vida ilimitada, consumo mínimo (ses). Vitrine elegante e sofisticada. Design circular revolucionário com visão 360°. Temperatura de trabalho entre os 4° e 8°C.



Système d'illumination de dernière génération LEDS lumière froide, vie illimitée, consommation minimale (ses). Vitrine élégante et sophistiquée. Design rond révolutionnaire avec vision à 360°. Température de fonctionnement comprise entre 4° and 8 ° C.





Sistema de iluminación de última generación LEDS luz fría, vida ilimitada, mínimo consumo (ses). Vitrina elegante y sofisticada. Diseño circular revolucionario con visión 360°. Temperatura de trabajo entre 4° y 8°C.



Lighting system last generation light LEDS, cold, unlimited life, minimum power consumption (ses). Elegant and sophisticated showcase. Revolutionary circular design for 360° vision. Working temperature range 4° to 8°C.



MODELO / MODÈLE / MODELO / MODEL CÓDIGO / CODE / CÓDIGO / CODE	UDI BUFFET NEUTRO	
		3097.230 
<b>Preço / Prix / Precio / Price</b>	€	<b>2.499,00</b>
Dimensões / Dimensions / Dimensiones	mm	950x950x750
Nº Estantes / Nº Étagère / Nº Estante / Shelf Nº	nº	1
Medida Estantes / Mesure étagère / Medida estante / Shelves measure	mm	390
Nº bandejas / Nº plateaux / Nº bandeja / Tray nº	nº	8 OPC
Leds / Leds / Leds / Leds	nº	20
Temperatura / Température / Temperatura / Temperature	°C	+4/+8
Evaporação Estática / Evaporadón statique / Evaporation estática / Static évaporation		✓
Tensão / Tension / Tensión / Tension	V	230

**CONTAINER**  
3097.237  
**30,00** 



Design container Buffet



opcional  
opcionnel  
optional



confirmar disponibilidade  
confirmer la disponibilité  
confirmar la disponibilidad  
confirm the availability





UDI

VITRINES REFRIGERADAS SELF  
VITRINES RÉFRIGÉRÉES SELF  
VITRINAS REFRIGERADAS SELF  
REFRIGERATED SHOWCASES SELF



 Sistema de iluminação de última geração High Power Leds, luz fria, vida ilimitada, consumo mínimo (ses). Portas frontais para self-service. Disponível sem containers cuba plana ou com containers gastronorm 1/3 40. Design original, fresco e dinâmico. Linha estilizada de grande visibilidade.

 Système d'illumination de dernière génération High Power Leds lumière froide, vie illimitée, consommation minime (ses). Avec portes avant pour self service. Possibilité de fourniture sans bacs, bac plat, ou avec bacs gastronorm 1/3 40. Design original, frais et dynamique ligne stylisée avec grand visibilité.

 Sistema de iluminación de última generación High Power Leds luz fría, vida ilimitada, mínimo consumo (ses). Puertas delanteras para autoservicio. Posibilidad de servir sin bandejas, cuba plana o con bandejas gastronorm 1/3 40. Diseño original, fresco y dinámico. Línea estilizada de gran visibilidad.

 Lighting system last generation light High Power Leds, cold, unlimited life, minimum power consumption (ses). Front doors for self service. Available without trays flat pan or with gastronorm 1/3 40 trays. Original fresh and dynamic design, stylized line with high visibility.

**Abertura frontal e traseira**  
Ouverture frontale et arrière  
Apertura frontal y trasera  
Rear and front opening



Cuba Gastronorm



Cuba Plana

UDI SELF 4BVC	UDI SELF 4BVC
3097.105	3097.090

UDI SELF 6BVC	UDI SELF 6BVC
3097.110	3097.095

UDI SELF 8BVC	UDI SELF 8BVC
3097.115	3097.100



**Design espetacular de meia lua**  
Design spectaculaire du semi lune  
Diseño espectacular de media luna  
Spectacular half moon design



Container GN 1/3-40  
Incluído | Inclu | Incluido | Included

MODELO / MODÈLE / MODELO / MODEL CÓDIGO / CODE / CÓDIGO / CODE	UDI SELF 4BVC 3097.105	UDI SELF 4BVC 3097.090	UDI SELF 6BVC 3097.110	UDI SELF 6BVC 3097.095	UDI SELF 8BVC 3097.115	UDI SELF 8BVC 3097.100
<b>Preço / Prix / Precio / Price</b>	€ 1.467,00	1.491,00	1.770,00	1.795,00	1.904,00	1.940,00
Dimensões / Dimensions / Dimensiones	mm 1085x395x245	1085x395x245	1438x395x245	1438x395x245	1788x395x245	1788x395x245
Nº bandejas / N° plateaux/ N° bandeja / Tray n°	n° 4	4	6	6	8	8
leds/ Leds / Leds / Leds	4	4	6	6	8	8
Vidro / Verre/Cristal/Glass	Temp	Temp	Temp	Temp	Temp	Temp
Temperatura / Température / Temperatura / Temperature	°C +2/+6	+2/+6	+2/+6	+2/+6	+2/+6	+2/+6
Evaporação Estática / Evaporadón statique / Evaporation estatica / Static évaporation	✓	✓	✓	✓	✓	✓
Carga Gás refrigerante / Gaz réfrigérant / Gas refrigerante / Refrigerating gas	160/165GR	160/165GR	170/175GR	170/175GR	180/185GR	180/185GR
Capacidade da câmara / Chambre capacite/ Capacidad câmara/ Chamber capacity	CUBA PLANA	4 GN1/3X40	CUBA PLANA	6 GN 1/3X40	CUBA PLANA	8 GN 1/3X40
Tensão / Tension / Tensión / Tension	V 230	230	230	230	230	230

 Container GN 1/3-40  
 Incluído | Inclu | Incluído | Included



MODELO / MODÈLE / MODELO / MODEL CÓDIGO / CODE / CÓDIGO / CODE		SHARK SK6P VC 3097.508	SHARK SK6 VC 3097.504	SHARK SK8P VC 3097.510	SHARK SK8 VC 3097.506
<b>Preço / Prix / Precio / Price</b>	€	<b>1.588,00</b>	<b>1.612,00</b>	<b>1.710,00</b>	<b>1.739,00</b>
Dimensões / Dimensions / Dimensiones	mm	1438x395x270	1438x395x270	1788x395x270	1788x395x270
Nº bandejas / N° plateaux / N° bandeja / Tray nº	nº	Cuba Plana	6	Cuba Plana	8
Tipo bandejas / Type plateaux / Tipo bandeja / Tray type		-	1/3x40	-	1/3x40
Leds/ Leds / Leds / Leds		6	6	8	8
Vidro / Verre/Cristal/Glass		Temp	Temp	Temp	Temp
Temperatura / Température / Temperatura / Temperature	°C	+2/+6	+2/+6	+2/+6	+2/+6
Evaporação Estática / Evaporación statique / Evaporation estática / Static évaporation		√	√	√	√
Tensão / Tension / Tensión / Tension	v	230	230	230	230

**Vidro abatível com sistema antiqueda e zona motor completamente protegida.**

Verre pliant avec système antichute et zone moteur totalement protégée.

Vidrio abatible con sistema anticaída y área motor completamente protegida.

Reclining glass with fall protection system and completely protected engine area.

 Outras cores sob pedido / Autres couleurs sur demande  
 Otros colores bajo pedido / Other colors on request

MODELO / MODÈLE / MODELO / MODEL CÓDIGO / CODE / CÓDIGO / CODE		UDI 4B-VC 3097.020	UDI 4B-VC 3097.005	UDI 6B-VC 3097.025	UDI 6B-VC 3097.010	UDI 8B-VC 3097.030	UDI 8B-VC 3097.015
<b>Preço / Prix / Precio / Price</b>	€	<b>1.333,00</b>	<b>1.369,00</b>	<b>1.479,00</b>	<b>1.527,00</b>	<b>1.685,00</b>	<b>1.746,00</b>
Dimensões / Dimensions / Dimensiones	mm	1085x395x245	1085x395x245	1438x395x245	1438x395x245	1788x395x245	1788x395x245
Nº bandejas/ N° plateaux / N° bandeja / Tray nº	nº	Cuba Plana	4	Cuba Plana	6	Cuba Plana	8
Tipo bandejas / Type plateaux / Tipo bandeja / Tray type		-	1/3x40	-	1/3x40	-	1/3x40
Leds/ Leds / Leds / Leds		4	4	6	6	8	8
Vidro / Verre/Cristal/Glass		Temp	Temp	Temp	Temp	Temp	Temp
Temperatura / Température / Temperatura / Temperature	°C	+2/+6	+2/+6	+2/+6	+2/+6	+2/+6	+2/+6
Evaporação Estática / Evaporación statique / Evaporation estática / Static évaporation		√	√	√	√	√	√
Tensão / Tension / Tensión / Tension	v	230	230	230	230	230	230



UDI

**VITRINES REFRIGERADAS STANDARD - 2 PLANOS**

VITRINES RÉFRIGÉRÉES STANDARD - 2 PLANS

VITRINA REFRIGERADA STANDARD - 2 PLANES

REFRIGERATED SHOWCASES STANDARD - 2 LEVELS



MODELO / MODELE / MODELO / MODEL CÓDIGO / CODE / CÓDIGO / CODE		SHARK SK26 VC LEDS 3097.512	SHARK SK28 VC LEDS 3097.514
<b>Preço / Prix / Precio / Price</b>	€	<b>1.766,00</b>	<b>1.880,00</b>
Dimensões / Dimensions / Dimensiones	mm	1438x395x340	1788x395x340
Nº Estantes / N° Étagere / N° Estante / Shelf N°	n°	1	1
Medida Estantes / Mesure étagere / Medida estante / Shelves measure	mm	1075x195	1425x195
Nº bandejas / N°plateux / N° bandeja / Tray n°	n°	6	8
Tipo bandejas/Type plateux/Tipo bandeja / Traytype		1/3x40	1/3x40
LedS/ Leds / Leds / Leds	n°	6	8
Vidro / Verre/ Cristal /Glass		Temp	Temp
Temperatura / Température / Temperatura / Temperature	°C	+2/+6	+2/+6
Condensadores / Condensateur/ Condensador / Condenser		1	1
Turbo ventiladores / Turbo ventilateurs / Turbo ventiladores / Turbo Ventilators		✓	✓
Ventiladores / Ventilateurs / Ventiladores / Ventilators		1	1
Evaporação Estática / Evaporadónstática/Evaporationestática/ Staticévaporation	n°	✓	✓
Tensão / Tension / Tensión / Tension	v	230	230



Outras cores sob pedido  
Autres couleurs sur demande  
Otros colores bajo pedido  
Other colors on request



\*UDI 6B-VC c/Leds  
Negro

Container GN 1/3-40  
Incluído | Inclu | Incluído | Included

MODELO / MODELE / MODELO / MODEL CÓDIGO / CODE / CÓDIGO / CODE		UDI 4B VC C/LEDS 3097.035	UDI 6B VC C/LEDS 3097.040	UDI 18B VC C/LEDS 3097.045
<b>Preço / Prix / Precio / Price</b>	€	<b>1.564,00</b>	<b>1.770,00</b>	<b>1.977,00</b>
Dimensões / Dimensions / Dimensiones	mm	1085x395x360	1438x395x360	1788x395x360
Nº Estantes / N° Étagere / N° Estante / Shelf N°	n°	1	1	1
Medida Estantes / Mesure étagere / Medida estante / Shelves measure	mm	720x195	1075x195	1425x195
Nº bandejas / N°plateux / N° bandeja / Tray n°	n°	4	6	8
Tipo bandejas/Type plateux/Tipo bandeja / Traytype		1/3x40	1/3x40	1/3x40
LedS/ Leds / Leds / Leds	n°	4	6	8
Vidro / Verre/ Cristal /Glass		Temp	Temp	Temp
Temperatura / Température / Temperatura / Temperature	°C	+2/+6	+2/+6	+2/+6
Condensadores / Condensateur/ Condensador / Condenser		1	1	1
Turbo ventiladores / Turbo ventilateurs / Turbo ventiladores / Turbo Ventilators		✓	✓	✓
Ventiladores / Ventilateurs / Ventiladores / Ventilators		1	1	1
Evaporação Estática / Evaporadónstática/Evaporationestática/ Staticévaporation	n°	✓	✓	✓
Tensão / Tension / Tensión / Tension	v	230	230	230

\* Possibilidade de iluminação dupla / Possibilité d'illumination double / Posibilidad de doble iluminación / Double lighting possibility



**Prateleira de vidro temperado duplo**  
Étagère de verre tempéré double  
Doble estante de cristal templado  
Double tempered glass shelf



**Sólida construção em aço inox**  
Solide construction en acier inox  
Solida construcción en acero inox  
Solid stain steel construction



**Prateleira superior protegida**  
Étagère supérieur protégée  
Estante superior protegido de golpes  
Upper shelf strikes protected



**Espetacular design "cubo"**  
Spetaculaire design "cube"  
Espectacular diseño cube  
Spectacular "cube" design

Container GN 1/3-40  
Incluído | Inclu | Incluido | Included

MODELO / MODELE / MODELO / MODEL		UDI CUBO 4	UDI CUBO 6	UDI CUBO 8
CÓDIGO / CODE / CÓDIGO / CODE		3097.078	3097.080	3097.085
<b>Preço / Prix / Precio / Price</b>	<b>€</b>	<b>1.546,00</b>	<b>1.673,00</b>	<b>1.916,00</b>
Dimensões / Dimensions / Dimensiones	mm	1085x395x360	1438x395x360	1788x395x360
Nº Estantes / Nº Étagère / Nº Estante / Shelf Nº	nº	1	1	1
Medida Estantes / Mesure étagère / Medida estante / Shelves measure	mm	720x195	1075x195	1425x195
Nº bandejas / Nº plateau / Nº bandeja / Tray nº	nº	4	6	8
Leds/ Leds / Leds / Leds	nº	4	6	8
Vidro / Verre / Cristal / Glass		Temp	Temp	Temp
Temperatura / Température / Temperatura / Temperature	°C	+2/+6	+2/+6	+2/+6
Condensadores / Condensateur / Condensador / Condenser	nº	1	1	1
Turbo ventiladores / Turbo ventilateurs / Turbo ventiladores / Turbo Ventilators		√	√	√
Ventiladores / Ventilateurs / Ventiladores / Ventilators	nº	1	1	1
Evaporação Estática / Evapoiación statique / Evaporation estática / Static évaporation		√	√	√
Tensão / Tension / Tensión / Tension	V	230	230	230



\* Possibilidade de cuba plana sob consulta / Possibilité de cuve plane sur demande / Posibilidad de cuba plana a pedido / Possibility of flat vat on request





UDI

**VITRINES REFRIGERADAS SUSHI**  
VITRINES RÉFRIGÉRÉES SUSHI  
VITRINA REFRIGERADA SUSHI  
REFRIGERATED SHOWCASE SUSHI



Conserva os alimentos entre 2° e 6°C, em todo o ambiente interior, com uma temperatura ambiente exterior máxima de 25°C. Duplo evaporador de alto rendimento. Tabuleiro de recolha de água que impede o gotejamento nos alimentos.



Conservation des aliments entre 2° e 6°C dans toute l'ambiance intérieure pour une température ambiante maximale de 25°C. Double évaporateur, haute performance. Plateau récupérateur d'eau, ce qui évite à l'eau de couler sur les aliments.



Conserva los alimentos entre 2° e 6°C en todo el ambiente interior, con una temperatura ambiente exterior máxima de 25°C. Doble evaporador de alto rendimiento. Bandeja recogedora de agua que evita goteos sobre los alimentos.



Food conservation between 2° e 6°C in the whole interior ambient for a maximum room temperature of 25°C. Double evaporator, high performance. Tray to pick up the water to avoid it to drip on the food.

**NOVO**  
NOUVEAU  
NUEVO  
NEW



MODELO / MODÈLE / MODELO / MODEL		SHARK SK6SP	SHARK SK6S	SHARK SK8SP	SHARK SK8S
CÓDIGO / CODE / CÓDIGO / CODE		3097.524	3097.520	3097.526	3097.522
Preço / Prix / Precio / Price	€	2.086,00	2.114,00	2.220,00	2.261,00
Dimensões / Dimensions / Dimensiones	mm	1438x 395x 270	1438x 395x 270	1788x 395x 270	1788x 395x 270
N° bandejas / N° plateaux / N° bandeja / Tray n°	n°	Cuba Plana	6	Cuba Plana	8
Tipo bandejas/Type plateaux/Tipo bandeja / Tray type		-	1/3x40	-	1/3x40
Leds / Leds / Leds / Leds	n°	6	6	8	8
Vidro / Verre / Cristal / Glass		Temp	Temp	Temp	Temp
Temperatura / Température / Temperatura / Temperature	°C	+2/+6	+2/+6	+2/+6	+2/+6
Evaporação Estática / Evaporación statique / Evaporation estática / Static évaporation		✓	✓	✓	✓
Tensão / Tension / Tensión / Tension	V	230	230	230	230

**NOVO**  
NOUVEAU  
NUEVO  
NEW



MODELO / MODÈLE / MODELO / MODEL		SHARK SK26SP	SHARK SK26S	SHARK SK28SP	SHARK SK28S
CÓDIGO / CODE / CÓDIGO / CODE		3097.532	3097.528	3097.534	3097.530
Preço / Prix / Precio / Price	€	2.232,00	2.261,00	2.408,00	2.448,00
Dimensões / Dimensions / Dimensiones	mm	1438x 395x 340	1438x 395x 340	1788x 395x 340	1788x 395x 340
N° bandejas / N° plateaux / N° bandeja / Tray n°	n°	Cuba Plana	6	Cuba Plana	8
Tipo bandejas/Type plateaux/Tipo bandeja / Tray type		-	1/3x40	-	1/3x40
Leds / Leds / Leds / Leds	n°	6	6	8	8
Vidro / Verre / Cristal / Glass		Temp	Temp	Temp	Temp
Temperatura / Température / Temperatura / Temperature	°C	+2/+6	+2/+6	+2/+6	+2/+6
Evaporação Estática / Evaporación statique / Evaporation estática / Static évaporation		✓	✓	✓	✓
Tensão / Tension / Tensión / Tension	V	230	230	230	230



Outras cores sob pedido / Autres couleurs sur demande  
Otros colores bajo pedido / Other colors on request

MODELO / MODÈLE / MODELO / MODEL		UDI SUSHI 4B-VC C/LEDS	UDI SUSHI 4B-VC C/LEDS	UDI SUSHI 6B-VC C/LEDS	UDI SUSHI 6B-VC C/LEDS	UDI SUSHI 8B-VC C/LEDS	UDI SUSHI 8B-VC C/LEDS	UDI SUSHI 10B-VC C/LEDS
CÓDIGO / CODE / CÓDIGO / CODE		3097.065	3097.050	3097.070	3097.055	3097.075	3097.060	3097.077
Preço / Prix / Precio / Price	€	1.770,00	1.819,00	1.916,00	1.965,00	2.183,00	2.232,00	2.585,00
Dimensões / Dimensions / Dimensiones	mm	1085x 395x 245	1085x 395x 245	1438x 395x 245	1438x 395x 245	1788x 395x 245	1788x 395x 245	2140x 395x 245
N° bandejas / N° plateaux / N° bandeja / Tray n°	n°	Cuba Plana	4	Cuba Plana	6	Cuba Plana	8	Cuba Plana
Tipo bandejas/Type plateaux/Tipo bandeja / Tray type		-	1/3x40	-	1/3x40	-	1/3x40	-
leds/ Leds / Leds / Leds	n°	4	4	6	6	8	8	10
Vidro / Verre/Cristal/Glass		Temp	Temp	Temp	Temp	Temp	Temp	Temp
Temperatura / Température / Temperatura / Temperature	°C	+2/+6	+2/+6	+2/+6	+2/+6	+2/+6	+2/+6	+2/+6
Evaporação Estática / Evaporación statique / Evaporation estática / Static évaporation		✓	✓	✓	✓	✓	✓	✓
Tensão / Tension / Tensión / Tension	V	230	230	230	230	230	230	230



Design atractivo para melhor apresentação de alimentos frescos, peixe, saladas ou sobremesas. Sistema de iluminação de última geração High Power Leds luz fria, vida ilimitada e consumo mínimo (ses). Vidros temperados. De fácil acesso aos alimentos pela sua dupla abertura self-service. Modelos construídos em aço inox AISI 316, anti corrosivo para a especial exposição direta de peixes e mariscos sobre a camada de gelo picado.



Design attrayant pour la meilleure présentation alimentaire de poisson frais, salade ou desserts. Système d'illumination de dernière génération High Power Leds lumière froide, vie illimitée, consommation minime (ses). Verres trempés. Faciliter l'accès aux aliments pour la double ouverture self service. Les modèles élaborés en acier AISI 316 boi anticorrosion pour l'exposition spéciale de fruits de mer direct sur lit de glace pilée.



Diseño atractivo para la mejor presentación de alimentos frescos, pescados, ensaladas o postres. Sistema de iluminación de última generación High Power Leds luz fría, vida ilimitada, mínimo consumo (ses). Cristales templados. Fácil acceso a los alimentos por su doble apertura Self Service. Modelos construídos con acero AISI316 anticorrosivo para la especial exposición directa de pescados y mariscos sobre camada de hielo picado.



Attractive design for the best presentation of fresh food, fish, salad or dessert. Lighting system last generation light high power leds, cold, unlimited life, minimum power consumption (ses). Tempered glasses. Easy access to food for your double opening self service. Models built with steel AISI 316 anticorr boi for the special exhibition of seafood direct on bed of crushed ice.



Carro em aço inox p. mod. udi fish 2/3  
Charriot en acier inoxydable  
Carro acero inox  
Stainless steel trolley



CARRO EM AÇO INOX PARA UDI FISH 2	CARRO EM AÇO INOX PARA UDI FISH 3
3097.130	3097.132
<b>737,00</b>	<b>804,00</b>
585x585x630	715x585x630



Abertura traseira  
Ouverture arriere  
Apertura trasera  
Rear opening

Container GN 1/1-65  
Incluído | Inclu | Incluido | Included

MODELO / MODÈLE / MODELO / MODEL CÓDIGO / CODE / CÓDIGO / CODE		UDI FISH 2-VC 3097.120	UDI FISH 3-VC 3097.125
<b>Preço / Prix / Precio / Price</b>	€	<b>2.876,00</b>	<b>3.496,00</b>
Dimensões / Dimensions / Dimensiones	mm	680x882x400	1000x882x400
Nº bandejas / Nº plateaux / Nº bandeja / Tray nº	nº	2	3
Tipo bandejas / Type plateaux / Tipo bandeja / Tray type	mm	1/1x65	1/1x65
leds/ Leds / Leds / Leds	nº	4	5
Temperatura / Température / Temperatura / Temperature	°C	+2/+6	+2/+6
Evaporação Estática / Evaporación statique / Evaporation estática / Static évaporation		√	√
Tensão / Tension / Tensión / Tension	V	230	230



opcional  
opcional  
opcional  
optional



UDI

**VITRINES EXPOSITORA BANHO MARIA / NEUTRAS**

VITRINES EXPOSANTS BAIN-MARIE / NEUTRES  
VITRINAS EXPOSITORAS BAÑO-MARIA / NEUTRAS  
BAN-MARIE EXHIBITOR SHOWCASES / NEUTRAL



**BANHO-MARIA / BAIN MARIE  
BAÑO-MARIA / BAIN MARIE**

**AQUECIDO / CHAUFFÉE  
CALIENTE / HEATED**

MODELO / MODÈLE / MODELO / MODEL CÓDIGO / CODE / CÓDIGO / CODE		SHARK CK24L 3097.536	SHARK CK26L 3097.538	SHARK SHK24L 3097.540	SHARK CK26L 3097.542
<b>Preço / Prix / Precio / Price</b>	€	<b>1.175,00</b>	<b>1.296,00</b>	<b>1.309,00</b>	<b>1.418,00</b>
Dimensões / Dimensions / Dimensiones	mm	840x395x340	1190x395x340	840x395x340	1190x395x340
Nº bandejas / N° plateaux / N° bandeja / Tray nº	nº	4	6	-	-
Tipo bandejas/Type plateaux/Tipo bandeja/Tray type		1/3x40	1/3x40	-	-
Leds / Leds / Leds / Leds		√	√	√	√
Vidro / Verre / Cristal / Glass		Temp	Temp	Temp	Temp
Temperatura / Température / Temperatura / Temperature	°C	90	90	90	90
Peso / Poids / Peso / Weight	kg	30	40	30	40
Potência / Puissance / Potencia / Power	W	800	1000	800	1000
Tensão / Tension / Tensión / Tension	V	230	230	230	230

**AQUECIDO / CHAUFFÉE  
CALIENTE / HEATED**



Frente  
Avant  
Frente  
Front

Traseira  
Arrière  
Trasera  
Rear

MODELO / MODÈLE / MODELO / MODEL CÓDIGO / CODE / CÓDIGO / CODE		UDI4B-VC 3097.135
<b>Preço / Prix / Precio / Price</b>	€	<b>750,00</b>
Dimensões / Dimensions / Dimensiones	mm	840x395x270
Bandejas/Plateaux/Bandeja/Tray	nº	4
Tipo Bandejas/Type Plateaux/Tipo Bandejas/Tray type	mm	1/3-40
Leds/Leds/Leds/Leds		Não
Vidro/Verre/Cristal/Glass		Temperado
Temperatura/Température/Temperatura/Temperature	°C	90
Peso / Poids / Peso / Weight	kg	-
Potência / Puissance / Potencia / Power	W	800
Tensão / Tension / Tensión / Tension	V	230



Modelo com iluminação Led disponível  
Vidro temperado  
Fácil acesso aos alimentos  
Base em aço inoxidável  
Fácil limpeza



Modèle avec illumination Led disponible  
Verres trempés  
Faciliter l'accès aux aliments  
Construit en acier inox  
Nettoyage facile



Modelo Led disponible  
Cristales templados  
Fácil acceso a los alimentos  
Construidas en acero inoxidable AISI 304,  
Con desagüe para facilitar la limpieza.



Led light model available  
Tempered glasses  
Easy access to food  
Built in stainless steel AISI 304  
Easy cleaning

**NEUTRO / NEUTRE / NEUTRO /  
NEUTRAL**



MODELO / MODÈLE / MODELO / MODEL CÓDIGO / CODE / CÓDIGO / CODE		UDI 4N-VC LED 3097.309	UDI 6N-VC LED 3097.311
<b>Preço / Prix / Precio / Price</b>	€	<b>567,00</b>	<b>640,00</b>
Dimensões / Dimensions / Dimensiones	mm	840x380x170	1190x380x170
Leds/Leds/Leds/Leds		√	√
Vidro/Verre/Cristal/Glass		Temperado	Temperado
Tensão / Tension / Tensión / Tension	V	230	230



confirmar disponibilidade  
confirmer la disponibilité  
confirmar la disponibilidad  
confirm the availability



CF1200 - Carro de serviço em madeira de nogueira com tampo giratório; Placa de cozedura em aço inoxidável com queimador ajustável.  
 CA1440 - Carro porta-pratos; Punhos laterais para movimentar o carro; Rodas Ø125 mm; Duas rodas com travão.  
 UDCPT17 - Carro para transportar tabuleiros, com 4 rodas.



CF1200 - Chariot de service contre-plaqué en noyer avec plan de service escamotable. Plan de cuisson en acier inoxydable avec brûleur réglable.  
 CA1440 - Chariots porte-assiettes; Poignées de conduite du chariot. Roulettes Ø 125mm; Deux roulettes avec frein.  
 UDCPT17 - Chariot pour transporter des plateaux avec 4 roues.



CF1200 - Carro de servicio en madera de nogal con tapa giratoria; Plancha de cocción de acero inoxidable con quemador ajustable.  
 CA1440 - Carro transporta platos; Mangos laterales para mover el carro; Ruedas de Ø125 mm; Dos ruedas con freno.  
 UDCPT17 - Carretilla para transporte de bandejas con 4 ruedas.



CF1200 - Wood service trolley in walnut with swivelling top; Cooking hob in stainless steel with adjustable burner.  
 CA1440 - Dish carts; Side handles to steer trolley; Wheels Ø 125mm; Two with brake.  
 UDCPT17 - Trolley for carrying trays with 4 wheels.



MODELO / MODELE / MODELO / MODEL	UDCSMI2
CÓDIGO / CODE / CÓDIGO / CODE	5700.804
<b>Preço / Prix / Precio / Price *</b>	<b>€ 320,00</b>
Dimensões / Dimensions / Dimensiones	mm 900x600x850
Capacidade de pratos / Capacité de Plats / Capacidad de platos / Dish capacity	nr -
Capacidade de Tabuleiros / Capacité de Plateaux / Capacidad de Bandejas / Tray capacity	nr -
Prateleiras / Etagères / Estantes / Shelves	nr 2



MODELO / MODELE / MODELO / MODEL	UDCSMI3
CÓDIGO / CODE / CÓDIGO / CODE	5700.808
<b>Preço / Prix / Precio / Price *</b>	<b>€ 380,00</b>
Dimensões / Dimensions / Dimensiones	mm 900x600x850
Capacidade de pratos / Capacité de Plats / Capacidad de platos / Dish capacity	nr -
Capacidade de Tabuleiros / Capacité de Plateaux / Capacidad de Bandejas / Tray capacity	nr -
Prateleiras / Etagères / Estantes / Shelves	nr 3



1 Placa + 1 Queimador  
 1 Plaque + 1 brûleur  
 1 Placa + 1 Quemador  
 1 Plate + 1 Burner

MODELO / MODELE / MODELO / MODEL	CF1200
CÓDIGO / CODE / CÓDIGO / CODE	3500.073
<b>Preço / Prix / Precio / Price *</b>	<b>€ 1.707,00</b>
Dimensões / Dimensions / Dimensiones	mm 1030x550x850
Capacidade de pratos / Capacité de Plats / Capacidad de platos / Dish capacity	nr -
Capacidade de Tabuleiros / Capacité de Plateaux / Capacidad de Bandejas / Tray capacity	nr -
Prateleiras / Etagères / Estantes / Shelves	nr -



GN 1/1

70mm entre guias  
 70mm entre les guides  
 70mm entre las guías  
 70mm between guides



MODELO / MODELE / MODELO / MODEL	UDCPT17 GN 1/1
CÓDIGO / CODE / CÓDIGO / CODE	5700.816
<b>Preço / Prix / Precio / Price *</b>	<b>€ 497,00</b>
Dimensões / Dimensions / Dimensiones	mm 385x580x1600
Capacidade de pratos / Capacité de Plats / Capacidad de platos / Dish capacity	nr -
Capacidade de Tabuleiros / Capacité de Plateaux / Capacidad de Bandejas / Tray capacity	nr 17
Prateleiras / Etagères / Estantes / Shelves	nr -

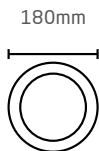

60mm entre pratos  
 60mm entre les plats  
 60mm entre platos  
 60mm between dishes



MODELO / MODELE / MODELO / MODEL	CA 1440
CÓDIGO / CODE / CÓDIGO / CODE	3500.090
<b>Preço / Prix / Precio / Price *</b>	<b>€ 1.255,00</b>
Dimensões / Dimensions / Dimensiones	mm 600x600x1750
Capacidade de pratos / Capacité de Plats / Capacidad de platos / Dish capacity	nr 96
Capacidade de Tabuleiros / Capacité de Plateaux / Capacidad de Bandejas / Tray capacity	nr -
Prateleiras / Etagères / Estantes / Shelves	nr -



confirmar disponibilidade  
 confirmer la disponibilité  
 confirmar la disponibilidad  
 confirm the availability



UDI

**PORTA-MALAS/ROUPAS**  
PORTE-MANTEAUX/VALISES  
PORTA MALETAS/ROPAS  
LUGGAGE/CLOTHING TROLLEY



Carros de serviço para colocar roupas na vertical. Base de madeira revestida com carpete, o suporte da roupa é feito em aço cromado. Rodas multidirecionais com batentes em borracha.



Porte-valises avec porte-manteaux. Base en bois couverte en moquette. Supporte barre tubolaire en acier chromé. Butoir périmétrale en gomme. Roues pivotantes.



Carros de servicio para poner la ropa. Base de madera revestida con alfombra. Soporte hecho de acero cromado. Ruedas multidireccionales con batientes revestidos en goma.



Luggage trolley with clothing stands. Wood base covered with moquette. Support tubular made of chromed steel. Multidirectional wheels coated in rubber.



MODELO / MODÈLE / MODELO / MODEL	RE 4016
CÓDIGO / CODE / CÓDIGO / CODE	3500.162
Preço / Prix / Precio / Price	€ 89,00
Dimensões / Dimensions / Dimensiones	mm 500x460x580



MODELO / MODÈLE / MODELO / MODEL	ST 4060
CÓDIGO / CODE / CÓDIGO / CODE	3500.168
Preço / Prix / Precio / Price	€ 154,00
Dimensões / Dimensions / Dimensiones	mm 2100x530x1520



MODELO / MODÈLE / MODELO / MODEL	PVI 4024
CÓDIGO / CODE / CÓDIGO / CODE	3500.166
Preço / Prix / Precio / Price	€ 665,00
Dimensões / Dimensions / Dimensiones	mm 1000x560x1600



MODELO / MODÈLE / MODELO / MODEL	PV 4064
CÓDIGO / CODE / CÓDIGO / CODE	3500.167
Preço / Prix / Precio / Price	€ 1.392,00
Dimensões / Dimensions / Dimensiones	mm 950x550x1900



As caixas térmicas são a solução ideal para a entrega segura e higiénica de alimentos. Devido ao seu ótimo isolamento, todos os produtos mantêm-se frescos durante muito tempo.



Les caisses thermiques sont la solution idéale pour la livraison sûre et hygiénique des aliments. En raison de son grand isolement, tous les produits restent frais pendant une longue période.



Las cajas térmicas son la solución ideal para la entrega segura y higiénica de los alimentos. Debido a su gran aislamiento, todos los productos permanecen frescos durante un largo tiempo.



The thermoboxes are the ideal solution for the safe and hygienic delivery of food. Due to its great isolation the products remain fresh for a long time.

## 601M GN1/1

VOLUME GERAL / VOLUME GLOBAL / VOLUME GENERAL / OVERALL VOLUME

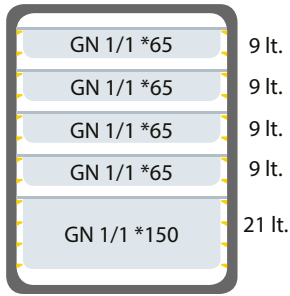

Total 57 lt.

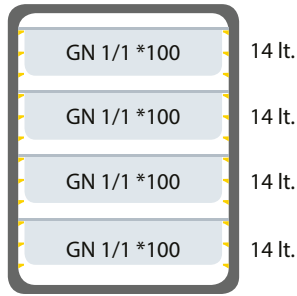

Total 56 lt.

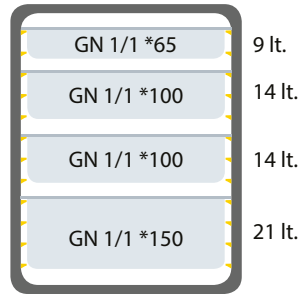

Total 58 lt.

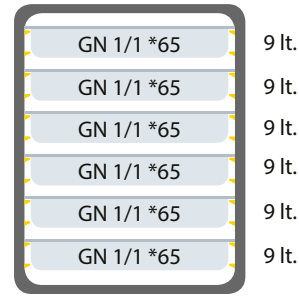

Total 54 lt.

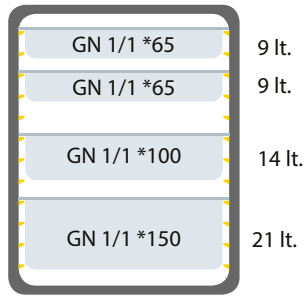

Total 53 lt.

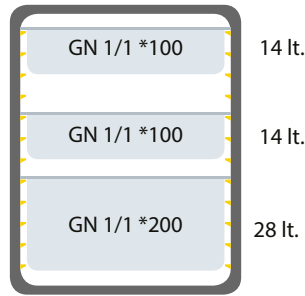

Total 56 lt.

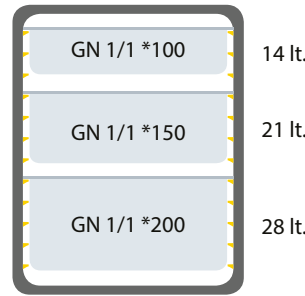

Total 56 lt.

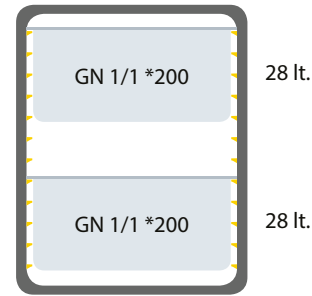

Total 56 lt.



Cód.	Ref.	€
5900.982	TAMPA HERMÉTICA GASTRONORM GN1/1	62,00
5900.984	TAMPA HERMÉTICA GASTRONORM GN1/2	41,00
5900.986	TAMPA HERMÉTICA GASTRONORM GN1/3	33,00
5900.988	TAMPA HERMÉTICA GASTRONORM GN1/4	32,00

MODELO / MODÈLE / MODELO / MODEL	CAIXA 600M GN 1/1	COVETE FRIA PACK CONGELATEUR COVETE FRIA FREEZER PACK	SUPORTE COM RODAS SUPPORT AVEC ROUES SOPORTE CON RUEDAS TROLLEY 600X2
CÓDIGO / CODE / CÓDIGO / CODE	5000.004	5000.010	5000.008
Preço / Prix / Precio / Price	€ 614,00	207,00	621,00
Dimensões Internas / Dimensions Intérieures / Dimensiones Internas / Internal Dimensions	mm 333x540x460	-x-x-	-x-x-
Dimensões Externas / Dimensions Externes / Dimensiones Externas / External Dimensions	mm 450x625x575	530x325x50	600x700x220
Capacidade / Capacité / Capacidad / Capacity	lt 83	-	-



opcional  
opcionnel  
opcional  
optional



confirmar disponibilidade  
confirmer la disponibilité  
confirmar la disponibilidad  
confirm the availability



UDI

CAIXAS TÉRMICAS  
CAISSE THERMIQUE  
CAJAS TÉRMICAS  
THERMOBOXES



As caixas térmicas são a solução ideal para a entrega segura e higiénica de alimentos. Devido ao seu ótimo isolamento, todos os produtos mantêm-se frescos durante muito tempo.



Les caisses thermiques sont la solution idéale pour la livraison sûre et hygiénique des aliments. En raison de son grand isolement, tous les produits restent frais pendant une longue période.



Las cajas térmicas son la solución ideal para la entrega segura y higiénica de los alimentos. Debido a su gran aislamiento, todos los productos permanecen frescos durante un largo tiempo.



The thermoboxes are the ideal solution for the safe and hygienic delivery of food. Due to its great isolation the products remain fresh for a long time.

## 600x2 GN2/1

VOLUME GERAL / VOLUME GLOBAL / VOLUME GENERAL / OVERALL VOLUME

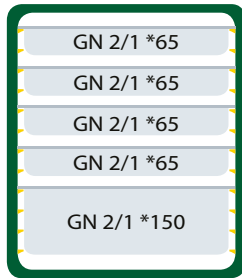

18.5 lt.  
18.5 lt.  
18.5 lt.  
18.5 lt.  
42.5 lt.

Total 116.5 lt.

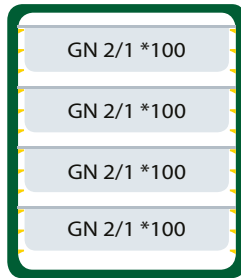

28.5 lt.  
28.5 lt.  
28.5 lt.  
28.5 lt.

Total 114 lt.



42.5 lt.  
42.5 lt.  
42.5 lt.

Total 127,5 lt.

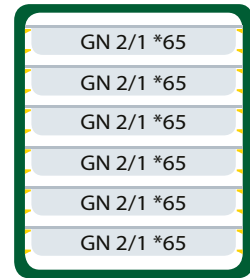

18.5 lt.  
18.5 lt.  
18.5 lt.  
18.5 lt.  
18.5 lt.

Total 111 lt.

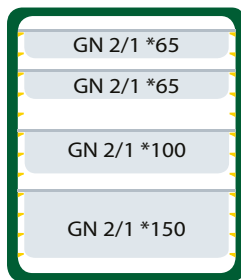

18.5 lt.  
18.5 lt.  
28.5 lt.  
42.5 lt.

Total 108 lt

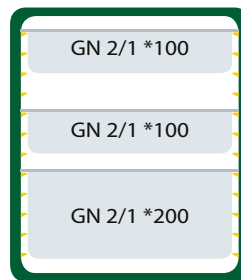

28.5 lt.  
28.5 lt.  
57.5 lt.

Total 114.5 lt

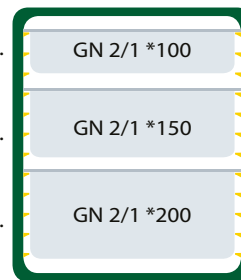

28.5 lt.  
42.5 lt.  
57.5 lt.

Total 128.5 lt

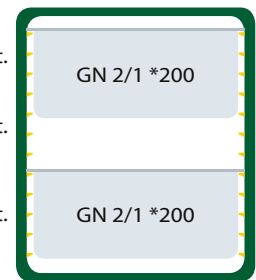

57.5 lt.  
57.5 lt.

Total 115 lt

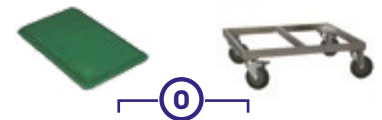

Cód.	Ref.	€
5900.982	TAMPA HERMÉTICA GASTRONORM GN1/1	62,00
5900.984	TAMPA HERMÉTICA GASTRONORM GN1/2	41,00
5900.986	TAMPA HERMÉTICA GASTRONORM GN1/3	33,00
5900.988	TAMPA HERMÉTICA GASTRONORM GN1/4	32,00

MODELO / MODÈLE / MODELO / MODEL	CAIXA TÉRMICA 600X2 GN2/1	COVETE FRIA PACK CONGELATEUR COVETE FRIA FREEZER PACK	SUPORTE COM RODAS SUPPORT AVEC ROUES SOPORTE CON RUEDAS TROLLEY 600X2
CÓDIGO / CODE / CÓDIGO / CODE	5000.002	5000.010	5000.008
Preço / Prix / Precio / Price	€ 1.211,00	207,00	621,00
Dimensões Interiores / Dimensions Intérieures / Dimensiones Interiores / Internal Dimensions	mm 535x670x500	-x-x-	-x-x-
Dimensões Externas / Dimensions Externes / Dimensiones Externas / External Dimensions	mm 670x765x620	530x325x50	600x700x220
Capacidade / Capacité / Capacidad / Capacity	lt 180	-	-





INSECT KILLER com estrutura em aço inox e laterais em PVC. Tem grelha de protecção e o tabuleiro em aço inox.



INSECT KILLER avec structure en acier inoxydable et latéraux en PVC. Ils ont une grille de protection et le plateau est en acier inoxydable.



INSECT KILLER con estructura en acero inox y laterales en PVC. Tienen parrilla de protección y bandeja en acero inox.



INSECT KILLER structure in stainless steel and PVC sides. With protection grill and container in stainless steel.

Parede / Mur / Pared / Wall

**LURALITE 2000  
BRANCO  
2058.901**

Parede e teto / Mur et plafond / Pared y techo / Wall and ceiling

**SATALITE  
18  
2058.931**

**FLYTRAP  
30 BRANCO  
INOX  
2058.932**      **FLYTRAP  
40 BRANCO  
INOX  
2058.933**
**PLACAS ADESIVAS**

MODELO / MODÈLE / MODELO / MODEL CÓDIGO / CODE / CÓDIGO / CODE	LURALITE 2000 BRANCO 2058.901	SATALITE 30 2058.931	FLYTRAP 30 BRANCO INOX 2058.932	FLYTRAP 40 BRANCO INOX 2058.933
<b>Preço / Prix / Precio / Price</b>	<b>€ 94,00</b>	<b>195,00</b>	<b>397,00</b>	<b>502,00</b>
Dimensões / Dimensions / Dimensiones	mm 200x465x170	540x317x135	475x185x355	623x185x355
Cobertura / Coverture / Cobertura / Cover	m2 30	60	80	120
Lâmpadas / Lampes / Lampadas / Tubes	w 1x18	2x15	2x15	2x20
Peso Bruto / Poids Brut / Peso Bruto / Gross Weight	kg 2,5	4,5	4	5
Potência / Puissance / Potencia / Power	W 18	30	30	40
Tensão / Tension / Tensión / Tension	V 230	230	230	230

**ELETROCUSSÃO**

MODELO / MODÈLE / MODELO / MODEL CÓDIGO / CODE / CÓDIGO / CODE	PLUSZAP 30 INOX 2058.939B
<b>Preço / Prix / Precio / Price</b>	<b>€ 178,00</b>
Dimensões / Dimensions / Dimensiones	mm 514x130x262
Cobertura / Coverture / Cobertura / Cover	m2 80
Lâmpadas / Lampes / Lampadas / Tubes	w 2x15
Peso Bruto / Poids Brut / Peso Bruto / Gross Weight	kg 3,5
Potência / Puissance / Potencia / Power	W 18
Tensão / Tension / Tensión / Tension	V 230



confirmar disponibilidade  
confirmer la disponibilité  
confirmar la disponibilidad  
confirm the availability





UDI

**EXTERMINADORES DE INSETOS - OPCIONAIS**

EXTERMINATEUR D'INSECTES - OPTIONNELS

EXTERMINADORES DE INSECTOS - OPCIONALES

INSECTS EXTERMINATOR - OPTIONALS



**PLACA ADESIVA / PLACA ADESIVA / PLACA ADESIVA / PLACA ADESIVA**

EXTERMINADORES DE INSETOS | EXTERMINATEUR D'INSECTES | EXTERMINADORES DE INSECTOS | INSECTS EXTERMINATOR

Cód.	Ref.	€
2058.945	LURALITE 2000 (CONJ.6)	16,00



Cód.	Ref.	€
2058.946	SATALITE 18 (CONJ.6)	17,00



Cód.	Ref.	€
2058.947	FLYTRAP 30 (CONJ.6)	30,00
2058.948	FLYTRAP 40 (CONJ.6)	32,00



**LAMPADAS / LAMPADAS / LAMPADAS / LAMPADAS**

EXTERMINADORES DE INSETOS | EXTERMINATEUR D'INSECTES | EXTERMINADORES DE INSECTOS | INSECTS EXTERMINATOR

Cód.	Ref.	€
2058.916	LAMPADA P/MODELO EX16 16W	7,00



Cód.	Ref.	€
2058.917	LAMPADA P/EUROZAP E EUROKILL16	10,00



confirmar disponibilidade  
confirmer la disponibilité  
confirmar la disponibilidad  
confirm the availability

Os trituradores de resíduos Z105/106 são destinados a pequenas comunidades, tais como caravanas, campismo, cantinas, centros de saúde, etc. Elimina todos os resíduos orgânicos da cozinha, tais como ossos de carne e frango, caroços das frutas, cascas de todos os tipos, vidro, etc. Os trituradores de lixo T421, T421 Special, 402MT são destinados a grandes comunidades, cantinas, restaurantes e em especial locais que tenham máquinas de lavar louça industriais. Têm uma função de esmagamento simples com efeito "bomba centrífugadora".

Les broyeurs de déchets T421, T421 spéciales, 402MT sont destinés pour les grandes communautés, cantines, restaurants et en particulier emplacement qui ont les lave-vaisselle industriels. Ont une fonction d'écrasement simple avec effet "pompe centrifuge".  
 Le broyeurs de déchets Z105/106 sont destinés à petites communautés, comme caravanes, camping, cantine, centres de santé, etc. Élimine tous les déchets organiques de la cuisine comme les os de viande et poulet, noyaux de fruits, coques de tous types, le verre, etc.

Los trituradores de basuras Z105/106 se destinan a las comunidades pequeñas, como caravanas, campismo, cantinas, centros de salud, etc. Elimina todos los residuos orgánicos de la cocina, tales como huesos de carne y pollo, carozos de frutas, cáscaras de todos tipos, vidrio, etc.  
 Los trituradores de basuras T421, T421 especiales, 402MT son destinados para las comunidades grandes, cantinas, restaurantes, especialmente en locales que tengan los lavavajillas industriales. Tienen una función de aplastamiento simples con efecto de "bomba centrífuga".

The Z105/106 garbage disposals are intended for small communities, such as caravans, camping, canteens, health centers, etc. Eliminates all the organic wastes of the kitchen such as chicken and steak bones, fruit stones, peel of every kind, glass, etc.  
 The garbage disposals T421, T421 Special, 402MT are intended for large communities, canteens, restaurants and in particular are found useful in places with industrial dishwashers. They have a simple crushing function with "pump effect".



**Z 105\***  
**2103.001**



**TM 451**  
**2103.015**



**ESPECIAL T 421**  
**2103.013**



**Z 106**  
**2103.003**



**T 421**  
**2103.005**

**detector de metais | détecteur de metal**  
**detetor metales | metal detector**

Cód.	Ref.	€
2103.055	P/ Z106	501
2103.062	P/ T300/402	579



MODELO / MODÈLE / MODELO / MODEL	Z 105*	Z 106 SEM MÓVEL	T 421	TM 451	ESPECIAL T 421
CÓDIGO / CODE / CÓDIGO / CODE	2103.001	2103.003	2103.005	2103.015	2103.013
<b>Preço / Prix / Precio / Price</b>	<b>€ 2.707,00</b>	<b>3.266,00</b>	<b>8.913,00</b>	<b>11.775,00</b>	<b>18.636,00</b>
Dimensões / Dimensions / Dimensiones	mm 170x190 x360	170x190 x445	327x632	-x-755	775x2270 x850/1800
Sem móvel / Sans armoire / Sin mueble / Without support	√	√	√	√	-
Com móvel / Avec armoire / Con mueble / With support	-	-	-	-	√
Diâmetro Entrada / Diamètre entrée / Diámetro Entrada / Inlet Diameter	mm 90	90	110	110	110
Peso Líquido / Poids Net / Peso Neto / Net Weight	kg 15	17	90	100	-
Cap. de dissipaçã / Quantité de déchets broyés / Capacidad de eliminación / Disposing Capacity	kg/h -	50-70	220-250	100-150	200-250
Potência / Puissance / Potencia / Power	Hp 0,5	1,5	4	5,5	4
Tensão / Tension / Tensión / Tension	V 230	400	400	400	400



UDI



sob pedido  
sur demande  
a pedido  
on request

**TRITURADORES DE DETRITOS - DETECTOR DE METAIS**  
BROYEURS À DÉCHETS - DETECTEUR DE METAL  
TRITURADORES DE BASURAS - DETECTOR DE METAL  
GARBAGE DISPOSAL UNITS - METAL DETECTOR



O modelo T300 é destinado a comunidades de média dimensão, tais como cantinas, restaurantes, etc. Tem uma sistema de esmagamento simples. Os modelos B501/701 são especialmente destinados a grandes comunidades, tais como hotéis, restaurantes e hospitais.



Le modèle T300 est destiné pour les moyennes communautés, comme cantines, restaurants, etc. A un système d'écrasement simple. Les modèles B501/701 sont spécialement conçus pour les grandes communautés, comme les hôtels, restaurants et hôpitaux.



El modelo T300 está diseñado para comunidades medianas, tales como cantinas, restaurantes, etc. Tiene un sistema de aplastamiento simples. Los modelos B501/701 están especialmente diseñados para las comunidades grandes, tales como hoteles, restaurantes y hospitales.



The T300 model is designed for medium sized communities, such as canteens, restaurants, etc. It has a simple crushing system. The B501/701 models are specially designed for large communities, such as hotels, restaurants and hospitals.



**Z 106**  
**2103.070**

Com detector de metais  
Avec detecteur de metal  
Con detector metales  
With metal detector



**T 300**    **T 402**    **B 501**  
**2103.072**    **2103.074**    **2103.076**

Com detector de metais  
Avec detecteur de metal  
Con detector metales  
With metal detector



**T 402 MT**    **B 701**  
**2103.012**    **2103.009**

Sem detector de metais  
Sans detecteur de metal  
Sin detector metales  
Without metal detector

MODELO / MODÈLE / MODELO / MODEL	Z 106 COM MÓVEL	T 402	T 402 MT	T 300	B 501	B 701
CÓDIGO / CODE / CÓDIGO / CODE	2103.002	2103.004	2103.012	2103.010	2103.014	2103.009
Preço / Prix / Precio / Price	€ 6.945,00	16.535,00	17.701,00	11.464,00	24.498,00	30.004,00
Dimensões / Dimensions / Dimensiones	mm 440x560x850	400x700x850	700x700x850	400x700x850	400x700x850	700x700x850
Com móvel / Avec armoire / Con mueble / With support	√	√	√	√	√	√
Diâmetro Entrada / Diamètre entrée / Diámetro Entrada / Inlet Diameter	mm 90	110	-	-	142	170
Peso Líquido / Poids Net / Peso Neto / Net Weight	kg 45	130	140	120	230	330
Cap. de dissipação / Quantité de déchets broyés / Capacidad de eliminación / Disposing Capacity	kg/h 50-70	220-250	220-250	100-150	300-400	400-600
Potência / Puissance / Potencia / Power	Hp 1,5	4	4	3	5,5	7,5
Tensão / Tension / Tensión / Tension	V 400	400	400	400	400	400

Com detector de metais  
Avec detecteur de metal  
Con detector metales  
With metal detector

MODELO / MODÈLE / MODELO / MODEL	Z 106	T 402	T 300	B 501	B 701
CÓDIGO / CODE / CÓDIGO / CODE	2103.070	2103.074	2103.072	2103.076	2103.078
Preço / Prix / Precio / Price	€ 7.638,00	17.685,00	12.614,00	26.023,00	31.856,00
Dimensões / Dimensions / Dimensiones	mm 600x470x900	400x700x850	400x700x850	400x700x850	700x700x850
Com móvel / Avec armoire / Con mueble / With support	√	√	√	√	√
Peso Líquido / Poids Net / Peso Neto / Net Weight	kg -	130	120	230	330
Cap. de dissipação / Quantité de déchets broyés / Capacidad de eliminación / Disposing Capacity	kg 50-70	220-250	100-150	300-400	400-600
Potência / Puissance / Potencia / Power	Hp 1,5	4	3	5,5	7,5
Tensão / Tension / Tensión / Tension	V 400	400	400	400	400



**Equipamento melhorado para maior fiabilidade e durabilidade**  
Construção em aço inox AISI 304  
Com temporizador, tampa com microswitch de segurança  
Válvula de água e disco extraível para fácil limpeza



**Équipement amélioré pour une plus grande fiabilité et durabilité**  
Construction en acier inoxydable AISI 304  
Avec minuterie, couvercle avec micro-interrupteur de sécurité  
Valve à eau et disque amovible pour un nettoyage facile



**Equipamiento mejorado para una mayor fiabilidad y durabilidad**  
Construcción de acero inoxidable AISI 304  
Con temporizador, tapa con microswitch de seguridad  
Válvula de agua y disco extraíble para fácil limpieza



**Improved equipment for greater reliability and durability**  
AISI 304 stainless steel construction  
With timer, safety microswitch on the cover  
Water valve and removable plate for easy cleaning

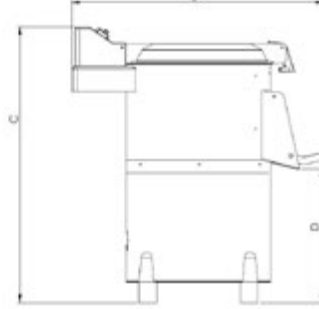
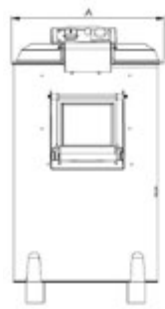

MODELO / MODÈLE / MODELO / MODEL CÓDIGO / CODE / CÓDIGO / CODE		UDDB10M	UDDB10TR	UDDB25TR	UDDB35TR	UDDB50TR
<b>Preço / Prix / Precio / Price</b>	€	<b>2.824,00</b>	<b>2.721,00</b>	<b>3.555,00</b>	<b>4.186,00</b>	<b>8.193,00</b>
Dimensões / Dimensions / Dimensiones	mm (ABC) (D)	425x720x730 445	425x720x730 445	520x850x935 440	520x850x1060 510	630x810x1050 520
Capacidade / Capacité / Capacidad / Capacity	kg	10	10	25	35	50
Produção / Production / Produccion / Production	kg/h	200	200	500	700	1000
Peso Líquido-Bruto / Poids Net-Brut / Peso Neto-Bruto / Net-Gross Weight	kg	40-45	40-45	62-72	68-77	114-140
Potência Motor / Puissance Moteur / Potência Motor / Power Motor	kW	0,55	0,55	1,1	1,5	1,1
Tensão / Tension / Tensión / Tension	V	230	400	400	400	400



Temporizador  
Placa Rotativa removível e cobertura com abrasivo durável.  
Tempo de peladura: 1 a 2 minutos  
Corpo e tanque em aço inoxidável.



Équipé d'une minuterie  
Plateau tournant amovible et boîtier recouvert d'abrasif durable  
Durée d'épluchage: 1-2 minute  
Corps et cuve en acier inoxydable



Equipado con temporizador  
Placa giratoria extraíble y durable cubierta con abrasivo  
Tiempo: 1-2 minutos  
Cuerpo de acero inoxidable.



Equipped with timer  
Removable rotating plate and housing covered with durable abrasive  
Peeling time: 1-2 minute  
Stainless steel body and tank

MODELO / MODÈLE / MODELO / MODEL CÓDIGO / CODE / CÓDIGO / CODE		PPF 5 K 230V	PPF 5 K 400V
<b>Preço / Prix / Precio / Price</b>	€	<b>2.405,00</b>	<b>2.365,00</b>
Dimensões / Dimensions / Dimensiones	mm (ABC) (D)	850x550x 890	850x550x 890
Velocidade / Vitesse / Velocidad / Speed	rpm	350	350
Capacidade / Capacité / Capacidad / Capacity	kg	5	5
Produção / Production / Produccion / Production	kg/h	100	100
Peso Líquido / Poids Net / Peso Neto / Net Weight	kg	39	39
Potência Motor / Puissance Moteur / Potência Motor / Power Motor	kW	0,5	0,5
Tensão / Tension / Tensión / Tension	V	230	400



confirmar disponibilidade  
confirmer la disponibilité  
confirmar la disponibilidad  
confirm the availability



UDI

CUTTERS  
CUTTERS  
CUTTERS  
CUTTERS



Interruptor de segurança  
Estrutura em aço inoxidável



Interrupteur de sécurité  
Structure en acier inoxydable



Interruptor de seguridad  
Estructura de acero inoxidable



Safety switch  
Stainless steel structure



MODELO / MODÈLE / MODELO / MODEL	UDCT8 1400 RPM	
CÓDIGO / CODE / CÓDIGO / CODE	5200.020	
<b>Preço / Prix / Precio / Price</b>	<b>€</b>	<b>1.142,00</b>
Dimensões / Dimensions / Dimensiones	mm (LPA)	250x490x365
Dimensões cuba / Dimensions cuve / Dimensiones recipiente / Bowl dimensions	mm (O/P)	240x180
Capacidade / Capacidad / Capacidad / Capacity	lt	8
Rotação / Rotation / Rotación / Rotation	RPM	1400
Peso Líquido-Bruto / Poids Net-Brut / Peso Neto-Bruto / Net-Gross Weight	kg	20-30
Potência / Puissance / Potência / Power	kW	0,37
Tensão / Tension / Tensión / Tension	V	230



MODELO / MODÈLE / MODELO / MODEL	UDCT8 900RPM	
CÓDIGO / CODE / CÓDIGO / CODE	5200.024	
<b>Preço / Prix / Precio / Price</b>	<b>€</b>	<b>1.299,00</b>
Dimensões / Dimensions / Dimensiones	mm (LPA)	333x262x555
Dimensões cuba / Dimensions cuve / Dimensiones recipiente / Bowl dimensions	mm (O/P)	240x180
Capacidade / Capacidad / Capacidad / Capacity	lt	8
Rotação / Rotation / Rotación / Rotation	RPM	900
Peso Líquido-Bruto / Poids Net-Brut / Peso Neto-Bruto / Net-Gross Weight	kg	19-29
Potência / Puissance / Potência / Power	kW	0,37
Tensão / Tension / Tensión / Tension	V	230



MODELO / MODÈLE / MODELO / MODEL	UDCT15	
CÓDIGO / CODE / CÓDIGO / CODE	5200.022	
<b>Preço / Prix / Precio / Price</b>	<b>€</b>	<b>2.720,00</b>
Dimensões / Dimensions / Dimensiones	mm (LPA)	380x630x500
Dimensões cuba / Dimensions cuve / Dimensiones recipiente / Bowl dimensions	mm (O/P)	290x220
Capacidade / Capacidad / Capacidad / Capacity	lt	15
Rotação / Rotation / Rotación / Rotation	RPM	1500/3000
Peso Líquido-Bruto / Poids Net-Brut / Peso Neto-Bruto / Net-Gross Weight	kg	47-57
Potência / Puissance / Potência / Power	kW	0,6 - 0,9
Tensão / Tension / Tensión / Tension	V	380



MODELO / MODÈLE / MODELO / MODEL	CVI MANUAL INOX	
CÓDIGO / CODE / CÓDIGO / CODE	4800.030	
<b>Preço / Prix / Precio / Price</b>	<b>€</b>	<b>249,00</b>
Dimensões / Dimensions / Dimensiones	mm (LPA)	450x200x205
Peso Líquido-Bruto / Poids Net-Brut / Peso Neto-Bruto / Net-Gross Weight	kg	5-6
Espessura do Corte / Epaisseur de coupe / Espesor de Corte / Cut Thickness	mm	4
Lâminas / Lames / Cuchillas / Blades	nr	13

Ø - diâmetro / diamètre / diámetro / diameter | P - profundidade / profondeur / profundidad / depth



confirmar disponibilidade  
confirmer la disponibilité  
confirmar la disponibilidad  
confirm the availability



O cortador de legumes satisfaz todas as necessidades possíveis na preparação de vegetais, frutas e legumes. A máquina tem uma variedade de discos de corte.



La cortadora de verduras satisface todas las necesidades en la preparación de verduras, frutas y legumbres. La máquina tiene una variedad de discos de corte.



Le coupe-légumes satisfait tous les besoins dans la préparation des végétales, des fruits et des légumes. La machine dispose d'une variété de disques à couper.



The vegetable cutter satisfies every possible need in the preparation of vegetables, fruits and legumes. The machine has a variety of discs to cut.



Diam. Boca -  
155x75mm  
OVAL

MODELO / MODÈLE / MODELO / MODEL	TV 2500	
CÓDIGO / CODE / CÓDIGO / CODE	2088.710	
<b>Preço / Prix / Precio / Price</b>	€	<b>940,00</b>
Dimensões / Dimensions / Dimensiones	mm	220x610x520
Peso Líquido-Bruto / Poids Net-Brut / Peso Neto-Bruto / Net-Gross Weight	kg	22-24
Potência / Puissance / Potencia / Power	kW	0,37
Tensão / Tension / Tensión / Tension	v	230



Diam. Boca -  
155x75mm  
OVAL

MODELO / MODÈLE / MODELO / MODEL	TV 2000R	TV 2000R
CÓDIGO / CODE / CÓDIGO / CODE	2088.706	2088.707
<b>Preço / Prix / Precio / Price</b>	€	<b>1.218,00</b>
Dimensões / Dimensions / Dimensiones	mm	220x610x520
Peso Líquido-Bruto / Poids Net-Brut / Peso Neto-Bruto / Net-Gross Weight	kg	22-24
Potência / Puissance / Potencia / Power	kW	0,37
Tensão / Tension / Tensión / Tension	v	400



Diam. Boca -  
147x75mm  
OVAL

MODELO / MODÈLE / MODELO / MODEL	FNT	
CÓDIGO / CODE / CÓDIGO / CODE	2088.333	
<b>Preço / Prix / Precio / Price</b>	€	<b>1.266,00</b>
Dimensões / Dimensions / Dimensiones	mm	240x450x580
Peso Líquido-Bruto / Poids Net-Brut / Peso Neto-Bruto / Net-Gross Weight	kg	18-20
Potência / Puissance / Potencia / Power	kW	0,37
Tensão / Tension / Tensión / Tension	v	400



confirmar disponibilidade  
confirmer la disponibilité  
confirmar la disponibilidad  
confirm the availability



UDI

**MÁQUINAS UNIVERSAIS DE COZINHA - DISCOS**

MACHINES UNIVERSELES DE CUISINE - DISQUES

MÁQUINAS UNIVERSALES DE COCINA - DISCOS

UNIVERSAL KITCHEN MACHINES - DISCS

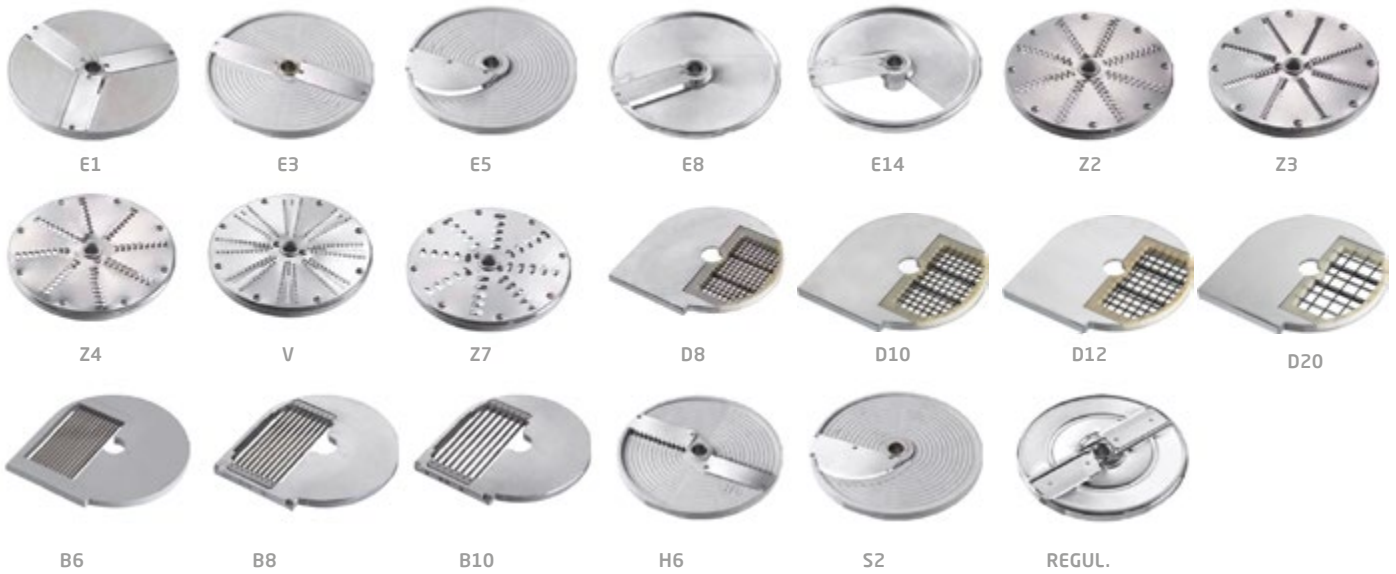

MODELO / MODÈLE / MODELO / MODEL	E1	E2	E3	E4	E5	E6	E8	E10	E14	Z2	Z3	Z4	V
CÓDIGO / CODE / CÓDIGO / CODE	2088.007	2088.040	2088.008	2088.041	2088.042	2088.009	2088.010	2088.013	2088.039	2088.043	2088.015	2088.044	2088.014
Preço / Prix / Precio / Price	€ 97,00	97,00	97,00	97,00	97,00	97,00	97,00	97,00	97,00	97,00	97,00	97,00	97,00

MODELO / MODÈLE / MODELO / MODEL	Z7	D8X8	D10X10	D12X12	D20X20	B6	B8	B10	H2,5	H4	H6	H8	H10
CÓDIGO / CODE / CÓDIGO / CODE	2088.045	2088.036	2088.012	2088.030	2088.038	2088.037	2088.011	2088.049	2088.046	2088.047	2088.034	2088.035	2088.048
Preço / Prix / Precio / Price	€ 97,00	167,00	167,00	145,00	145,00	123,00	123,00	123,00	123,00	123,00	123,00	123,00	123,00

MODELO / MODÈLE / MODELO / MODEL	S1	S2	PORTA DISCO	REGUL 1 A 8 MM
CÓDIGO / CODE / CÓDIGO / CODE	2088.049A	2088.049B	2088.331	2088.005
Preço / Prix / Precio / Price	€ 97,00	97,00	65,00	296,00

**DISCOS PARA CORTAR EM RODELAS**  
**E1 - E2 - S1 - S2:** Batata frita doce, nabo, repolho, pepino, cenoura, cogumelos e cebolas, caldo verde (E2).  
**E3:** Maças, bananas, batatas, abobrinhas, beringelas, erva-doce e alcachofras  
**E4 - E6:** Beterraba, batatas, repolhos, nabos e cebolas  
**E5:** Tomates, limões, laranjas, maçãs, abacaxi e uva  
**E8 - E10 - E14:** Batata cozida e cenoura, beringela e beterraba

**DISCOS PARA PICAR OU RALAR**  
**Z2 - Z3:** Cenouras, aipo, batatas, maçãs e nabos  
**Z4:** Beterraba, repolho roxo, rabanete, queijo gruyere e tipo de chocolate  
**V:** Queijo parmesão, pão seco, amêndoas, nozes, chocolate, avelãs.  
**Z7:** Mozzarella

**DISCOS PARA CORTE EM CUBOS**  
 A combinação dos discos D8x8 - D10 x D10 - D12 x D12 - D20 x D20 e modelos E8, E10, E14, permite obter um numero variado de cubos para saladas e sopas.

**DISCOS PARA CORTE NA FORMA DE PALITOS**  
**H2,5 - H4 - H6 - H8 - H10:** Aipo, courgettes, beterrabas, rabanetes, cenouras, batatas e nabos.  
 A combinação dos discos B6 - B8 - B10 com os discos E6 - E8 - E10 permite obter amostras com o comprimento do produto e a espessura desejada.

**DISQUES POUR COUPER EN TRANCHES**  
**E1 - E2 - S1 - S2:** Frites, céleri-rave, chou, concombres, carottes, oignons, champignons.  
**E3:** pommes, bananes, pommes de terre, courgettes, aubergines, fenouils, artichauts.  
**E4 - E6:** betteraves, pommes de terre bouillies, chou, céleris-raves, oignons.  
**E5:** tomates, citrons, oranges, pommes, ananas, pamplemousses.  
**E8 - E10 - E14:** pommes de terre et carottes bouillies, aubergines, betteraves.

**DISQUES POUR ÉMINCER OU RÂPER**  
**Z2 - Z3:** carottes, céleri, pommes de terre, courgettes, aubergines, fenouils, artichauts.  
**Z4:** betteraves, chou rouge, radis, fromage de type gruyère, chocolat.  
**V:** parmesan, pain sec, amandes, noix, chocolat, noisettes.  
**Z7:** mozzarella.

**DISQUES POUR LE DÉCOUPAGE EN PETITS CUBES**  
 La combinaison des disques D8x8 - D10x10 - D12x12 - D20x20 permet d'obtenir une vaste gamme de dés pour minestrone et macédoinnes.

**DISQUES POUR LE DÉCOUPAGE EN ALLUMETTES**  
**H2,5 - H4 - H6 - H8 - H10:** céleri, courgettes, betteraves, radis, carottes, pommes de terre, céleris-raves.  
 La combinaison des disques B6 - B8 - B10 aux E6 - E8 - E10 permet d'obtenir des allumettes sur toute la longueur de produit selon l'épaisseur voulue.

**DISCOS PARA CORTAR EN LONCHAS**  
**E1 - E2 - S1 - S2:** Patatas chips, nabos, repolhos, pepinos, zanahorias, cebollas y setas.  
**E3:** Manzanas, bananas, patatas, calabacines, berenjenas, hinojos y alcachofas.  
**E4 - E6:** Remolachas, patatas hervidas, repollos, nabos y cebollas.  
**E5:** Tomates, limones, naranjas, manzanas, ananás y pomelos.  
**E8 - E10 - E14:** Patatas y zanahorias hervidas, berenjenas y remolachas.

**DISCOS PARA DESMENUZAR O RALLAR**  
**Z2 - Z3:** Zanahorias, aipo, patatas, manzanas y nabos.  
**Z4:** Remolachas, repollo rojo, achicorias, queso tipo gruyere y chocolate.  
**V:** Queso parmesano, pan seco, almendras, nueces, chocolate, avellanas.  
**Z7:** Mozzarella.

**DISCOS PARA CORTE EN CUBITOS**  
 La combinación de los discos D8x8 - D10x10 - D12x12 - D20x20 permite obtener una variadísima serie de cubitos para menestras y macedonias.

**DISCOS PARA CORTE EN FORMA DE PAJA**  
**H2,5 - H4 - H6 - H8 - H10:** Apio, calabacines, remolacha, achicorias, zanahorias, patatas y nabos.  
 La combinación de los discos B6 - B8 - B10 con los discos E6 - E8 - E10 permite obtener bastoncillos con todo el largo del producto y con el espesor deseado.

**DISCS FOR SLICING**  
**E1 - E2 - S1 - S2:** Crisps, turnips, cabbage, carrots, onions and mushrooms.  
**E3:** Apples, bananas, potatoes, courgettes, aubergines, fennels, artichokes.  
**E4 - E6:** Beetroot, boiled potatoes, cabbage, turnips and onions.  
**E5:** Tomatoes, lemons, oranges, apples, pineapples and grapefruits.  
**E8 - E10 - E14:** Boiled potatoes and carrots, aubergines and beetroot.

**DISCS FOR SHREDDING /GRATING**  
**Z2 - Z3:** Carrots, celery, potatoes, apples and turnips.  
**Z4:** Beetroots, red cabbage, radishes, gruyere-type cheese and chocolate.  
**V:** Parmesan, dry bread, almonds, nuts, chocolate and hazelnuts.  
**Z7:** Mozzarella.

**DISCS FOR CUTTING IN CUBES**  
 The combination of discs D8 x 8 - D10 x 10 - D12 x 12 - D20 x 20 obtains a vast number of different types of cubes for minestrone and fruit salads.

**DISCS FOR CUTTING MATCHSTICK SIZE**  
**H2,5 - H4 - H6 - H8 - H10:** Celery, courgettes, beetroot, radishes, carrots, potatoes and turnips.  
 The combination of discs B6 - B8 - B10 with discs E6 - E8 - E10 obtains matchstick size pieces for the whole length of the food product with the desired thickness.



Esterilizador de facas construído em aço inoxidável polido scotch brite. Porta em acrílico transparente com microinterruptor de segurança. Lâmpada germicida UV 230 V 50/60 Hz 36W. Suporte de facas de aço inoxidável com grelha de proteção. Temporizador de 60' com lâmpada de sinal. Cabo com ficha. Altura útil: 50cm



Sterilisateur pour couteaux en acier inox poli scotch brite. Porte en plexiglas transparent fumé avec microinterrupteur de sécurité. Porte-couteaux en acier. Lampe germicide à UV 230 V 50/60 Hz 36W avec grille de protection. Minuterie 60' et lampe témoin. Cable avec prise. Hauteur utile: 50cm



Esterilizador para cuchillas fabricados en acero inoxidable pulido scotch brite. Puerta de acrílico transparente con microinterruptor de seguridad. Lámpara germicida UV 230 V 50/60 Hz 36W. Soporte de cuchillas de acero inoxidable con rejilla de protección. Temporizador de 60' con lámpara de señal. Cable con enchufe. Altura útil: 50cm



Knife sterilizer built in stainless steel scotch brite polished. Door in transparent perspex with safety microswitch. Germicide lamp UV 230 V 50/60 Hz 36W. Stainless steel knife holder with protection grid. Timer 60' with signal lamp. Cable with plug. Useful Height: 50cm

## Higienização eficaz da sua cutelaria

Un nettoyage efficace de vos coutellerie  
Limpieza eficaz de su cuchillería  
Effective cleaning of your cutlery

### Porta em Plexiglass

Porte Plexiglas  
Puerta de plexiglás  
Plexiglass door



0 - 120  
min.



MODELO / MODÈLE / MODELO / MODEL CÓDIGO / CODE / CÓDIGO / CODE	UDEST10 5200.040	
<b>Preço/ Prix / Precio / Price</b>	€	<b>361,00</b>
Dimensões / Dimensions / Dimensiones	mm	552x131x620
Peso Líquido-Bruto / Poids Net-Brut / Peso Neto-Bruto / Net-Gross Weight	kg	8,5-9
Cap. facas / Cap. couteaux / Cap. cuchillas / knives cap.	n°	10
Potência / Puissance / Potência / Power	w	100
Tensão / Tension / Tension / Tension	V	230



MODELO / MODÈLE / MODELO / MODEL CÓDIGO / CODE / CÓDIGO / CODE	UDEST20 5200.042	
<b>Preço/ Prix / Precio / Price</b>	€	<b>463,00</b>
Dimensões / Dimensions / Dimensiones	mm	1022x131x620
Peso Líquido-Bruto / Poids Net-Brut / Peso Neto-Bruto / Net-Gross Weight	kg	13-14
Cap. facas / Cap. couteaux / Cap. cuchillas / knives cap.	n°	20
Potência / Puissance / Potência / Power	w	200
Tensão / Tension / Tension / Tension	V	230

**FACAS ELÉTRICAS**  
COUTEAUX ÉLECTRIQUES  
CUCHILLO ELÉCTRICO  
CUCHILLOS ELÉCTRICOS



MODELO / MODÈLE / MODELO / MODEL CÓDIGO / CODE / CÓDIGO / CODE	ELN30 4800.032	
<b>Preço / Prix / Precio / Price</b>	€	<b>59,00</b>
Dimensões / Dimensions / Dimensiones	mm	140x470x70
Peso Líquido-Bruto / Poids Net-Brut / Peso Neto-Bruto / Net-Gross Weight	kg	1-1,5
Potência / Puissance / Potencia / Power	kW	0,18
Tensão / Tension / Tensión / Tension	V	230



confirmar disponibilidade  
confirmer la disponibilité  
confirmar la disponibilidad  
confirm the availability





UDI

**TRITURADORES E BATEDORES**  
TRITURATEUR ET FOUETS  
TRITURADORAS E BATIDORAS  
MIXERS



Concebidos para uso intensivo durante muitos anos, são muito potentes, podendo trabalhar com panelas de 5 a 150 litros. Fácil manutenção e limpeza rápida.



Ils ont été conçu pour une utilisation intensive pendant plusieurs années, très puissants, pouvant travailler avec des casseroles de 5 à 150 litres. Maintenance facile et nettoyage rapide.



Fueron concebidas para uso intensivo durante muchos años, son muy potentes, pudiendo trabajar con ollas de 5 a 150 litros. Fácil mantenimiento y limpieza rápida.



Recognized for the intensive use during many years, they are very powerful and can work with pots from 5 to 150 liters. Easy maintenance and fast cleaning.



30cm



40cm



40cm 50cm 60cm



MODELO / MODÈLE / MODELO / MODEL CÓDIGO / CODE / CÓDIGO / CODE		MX 25 30CM 2088.186
<b>Preço / Prix / Precio / Price</b>	€	<b>299,00</b>
Dimensões / Dimensions / Dimensiones	mm	135x100x600
Peso Líquido-Bruto / Poids Net-Brut / Peso Neto-Bruto / Net-Gross Weight	kg	2,2-3,4
Velocidade / Vitesse / Velocidad / Speed	rpm	13000
Potência / Puissance / Potencia / Power	w	250
Tensão / Tension / Tensión / Tension	v	230

MODELO / MODÈLE / MODELO / MODEL CÓDIGO / CODE / CÓDIGO / CODE		P/ MX 25 2088.185
<b>Preço / Prix / Precio / Price</b>	€	<b>139,00</b>
Dimensões / Dimensions / Dimensiones	mm	-x-300
Peso Líquido-Bruto / Poids Net-Brut / Peso Neto-Bruto / Net-Gross Weight	kg	0,6-1,1

MODELO / MODÈLE / MODELO / MODEL CÓDIGO / CODE / CÓDIGO / CODE		FX 40 2088.179
<b>Preço / Prix / Precio / Price</b>	€	<b>589,00</b>
Dimensões / Dimensions / Dimensiones	mm	170x120x740
Peso Líquido-Bruto / Poids Net-Brut / Peso Neto-Bruto / Net-Gross Weight	kg	4,5-6
Velocidade / Vitesse / Velocidad / Speed	rpm	15000
Potência / Puissance / Potencia / Power	w	400
Tensão / Tension / Tensión / Tension	v	230

MODELO / MODÈLE / MODELO / MODEL CÓDIGO / CODE / CÓDIGO / CODE		P/FX 40 2088.180
<b>Preço / Prix / Precio / Price</b>	€	<b>268,00</b>
Dimensões / Dimensions / Dimensiones	mm	170x120x300
Peso Líquido-Bruto / Poids Net-Brut / Peso Neto-Bruto / Net-Gross Weight	kg	2-3,2
Velocidade / Vitesse / Velocidad / Speed	rpm	15000
Potência / Puissance / Potencia / Power	w	400
Tensão / Tension / Tensión / Tension	v	230

MODELO / MODÈLE / MODELO / MODEL CÓDIGO / CODE / CÓDIGO / CODE		P/FX 40 2088.181	P/FX 40 2088.182	P/FX 40 2088.183
<b>Preço / Prix / Precio / Price</b>	€	<b>169,00</b>	<b>181,00</b>	<b>212,00</b>
Dimensões / Dimensions / Dimensiones	mm	-x-x400	-x-x500	-x-x600
Peso Líquido-Bruto / Poids Net-Brut / Peso Neto-Bruto / Net-Gross Weight	kg	1,4-1,9	1,6-2,1	1,8-2,3

MODELO / MODÈLE / MODELO / MODEL CÓDIGO / CODE / CÓDIGO / CODE		P/FX 40 2088.184
<b>Preço / Prix / Precio / Price</b>	€	<b>187,00</b>
Dimensões / Dimensions / Dimensiones	mm	-x-x355
Peso Líquido-Bruto / Poids Net-Brut / Peso Neto-Bruto / Net-Gross Weight	kg	1-1,5



1086M / IM4 CE Manual; 1086 / INT90 Elétrico - Ao introduzir o bife no amaciador, um conjunto de lâminas penetram em profundidade retirando-lhe todas as fibras musculares e nervos tornando a carne mais tenra.



1086M / IM4 CE Manual; 1086 / INT90 Électrique - En introduisant le bifteck de moyenne qualité dans l'attendrisseur, un millier de lames entrent en profondeur et coupent les fibres musculaires et les tendons, résultant une viande plus tendre.



1086M / IM4 CE Manual; 1086 / INT90 Elétrico - Introduciendo el filete en el ablandador, un juego de cuchillas penetran profundamente eliminando todos los nervios y fibras musculares quedando la carne más tierna.



1086M / IM4 CE Manual; 1086 / INT90 Electric - Introducing the steak in the tenderising unit, a set of blades go into depth cutting the muscle fibres off, making the meat more tender.



MODELO / MODÈLE / MODELO / MODEL CÓDIGO / CODE / CÓDIGO / CODE	IM4 CE 2086.155
Preço / Prix / Precio / Price	€ 1.788,00
Dimensões / Dimensions / Dimensiones	mm 270x330x280
Peso Líquido / Poids Net / Peso Neto / Net Weight	kg 9



MODELO / MODÈLE / MODELO / MODEL CÓDIGO / CODE / CÓDIGO / CODE	INT90E 2086.150
Preço / Prix / Precio / Price	€ 4.238,00
Dimensões / Dimensions / Dimensiones	mm 220x450x440
Peso Líquido / Poids Net / Peso Neto / Net Weight	kg 23
Potência / Puissance / Potencia / Power	kW 0,4
Tensão / Tension / Tensión / Tension	V 230

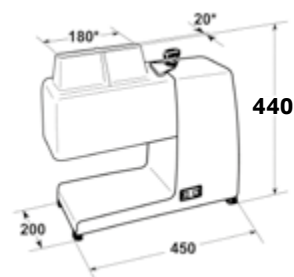

eléctrico  
 eléctrico  
 eléctrico  
 electric



manual  
 manual  
 manual  
 manual



UDI

**TRITURADORES DE CARNES REFRIGERADAS**

HACHOIRS DE VIANDE REFRIGÉRÉS

TRITURADORAS DE CARNES REFRIGERADAS

REFRIGERATED MEAT MINCERS



Picador de carne com sistema de refrigeração; Proteção de mãos; Com volante e espiral em aço inox; Botão de emergência (Stop); Estrutura em aço inox.



Hachoir à viande avec système de refroidissement; Protection des mains ; Avec volant et spirale en acier inoxydable ; Bouton d'urgence (Stop); Structure en acier inoxydable.



Picadora de carne con sistema de enfriamiento; Protección de mano; Con volante y espiral de acero inoxidable; Botón de emergencia (Stop); Estructura de acero inoxidable.



Meat mincer with cooling system; Hand protection; With steering wheel and stainless steel spiral; Emergency button (Stop); Stainless steel structure.



MODELO / MODÈLE / MODELO / MODEL CÓDIGO / CODE / CÓDIGO / CODE		UDPCR22M 5200.026	UDPCR22T 5200.028
<b>Preço / Prix / Precio / Price</b>	<b>€</b>	<b>3.584,00</b>	<b>3.348,00</b>
Dimensões / Dimensions / Dimensiones	mm	337x565x671	337x520x671
Produção / Production / Producción / Production	kg/h	400	400
Entrada carne / Entrée de la viande / Entrada de carne / Meat entrance	diam. (mm)	70	70
Peso Líquido / Poids Net / Peso Neto / Net Weight	kg	50	40
Potência / Puissance / Potencia / Power	kW/hp	2,2/-	2,2/-
Tensão / Tension / Tensión / Tension	V	230	400



MODELO / MODÈLE / MODELO / MODEL CÓDIGO / CODE / CÓDIGO / CODE		UDPCR22T 5300.014	UDPCR22T 5300.016
<b>Preço / Prix / Precio / Price</b>	<b>€</b>	<b>3.984,00</b>	<b>3.884,00</b>
Dimensões / Dimensions / Dimensiones	mm	320x790x460	320x790x460
Produção / Production / Producción / Production	kg/h	400	400
Entrada carne / Entrée de la viande / Entrada de carne / Meat entrance	diam. (mm)	-	-
Peso Líquido / Poids Net / Peso Neto / Net Weight	kg	75	75
Potência / Puissance / Potencia / Power	kW/hp	1,5/2	1,5/2
Tensão / Tension / Tensión / Tension	V	230	400



MODELO / MODÈLE / MODELO / MODEL CÓDIGO / CODE / CÓDIGO / CODE		UDPCR32T 5200.028A
<b>Preço / Prix / Precio / Price</b>	<b>€</b>	<b>3.867,00</b>
Dimensões / Dimensions / Dimensiones	mm	340x546x645
Produção / Production / Producción / Production	kg/h	600
Entrada carne / Entrée de la viande / Entrada de carne / Meat entrance	diam. (mm)	-
Peso Líquido / Poids Net / Peso Neto / Net Weight	kg	47
Potência / Puissance / Potencia / Power	kW/hp	2,2/-
Tensão / Tension / Tensión / Tension	V	400



MODELO / MODÈLE / MODELO / MODEL CÓDIGO / CODE / CÓDIGO / CODE		UDPCR32T 5300.020
<b>Preço / Prix / Precio / Price</b>	<b>€</b>	<b>4.319,00</b>
Dimensões / Dimensions / Dimensiones	mm	360x880x480
Produção / Production / Producción / Production	kg/h	600
Entrada carne / Entrée de la viande / Entrada de carne / Meat entrance	diam. (mm)	70
Peso Líquido / Poids Net / Peso Neto / Net Weight	kg	98
Potência / Puissance / Potencia / Power	kW/hp	3/4
Tensão / Tension / Tensión / Tension	V	400





**12S/22TE** - Discos de aço inoxidável (Ø furo 6mm), e lâmina de aço inoxidável com afiação automática.

**Mod. TC32** - Estrutura revestida por uma liga em aço inoxidável AISI 304. Motor auto ventilado. Caixa de alimentação e tabuleiro em aço inoxidável. Todas as peças da máquina podem ser facilmente limpas.

**22C** - Estrutura do corpo, funil e unidade de corte removível em aço inoxidável.



**12S/22TE** - Disques en acier inoxydable (trous de Ø 6mm), et la lame en acier inoxydable avec affûtage automatique.

**Mod. TC32** - Structure recouverte d'un alliage d'acier inoxydable AISI 304. Moteur auto-ventilé. Trémie et cuvette pour la viande inoxydable. Toutes les pièces de la machine peuvent être nettoyées facilement.

**22C** - Structure de corps, d'entonnoir et d'unité de coupe amovible en acier inoxydable.



**12S/22TE** - Discos de acero inoxidable (agujeros de 6 mm Ø), y hoja de acero inoxidable con afilado automático.

**Mod. TC32** - Estructura cubierta con una aleación de acero inoxidable AISI 304. Motor autoventilado. Caja de alimentación y bandeja de acero inoxidable. Todos los componentes de la máquina se lavan fácilmente.

**22C** - Estructura, embudo y unidad de corte extraíble en acero inoxidable.



**12S/22TE** - Stainless steel discs (Ø 6mm hole), and stainless steel blade with automatic sharpening.

**Mod. TC32** Structured in cast alloy cover entirely in stainless steel AISI 304. Self-ventilated motor. Stainless steel feedbox and meat pick-up tray. All the machine parts can be easily cleaned.

**22C** - Hopper, body and removable cutting unit in stainless steel.



MODELO / MODÈLE / MODELO / MODEL		12 S 400V	12 S 230V
CÓDIGO / CODE / CÓDIGO / CODE		2088.098	2088.096
<b>Preço / Prix / Precio / Price</b>	€	<b>1.112,00</b>	<b>1.168,00</b>
Dimensões / Dimensions / Dimensiones	mm	400x250x500	400x250x500
Produção / Production / Producción / Production	kg/h	160	160
Entrada carne / Entrée de la viande / Entrada de carne / Meat entrance	diam. (mm)	52	52
Peso Líquido-Bruto / Poids Net-Brut / Peso Neto-Bruto / Net-Gross Weight	kg	21-23	21-23
Potência / Puissance / Potencia / Power	kW/hp	0,75/1	0,75/1
Tensão / Tension / Tensión / Tension	V	400	230

MODELO / MODÈLE / MODELO / MODEL		22/TE CE 400V	22/TE CE 230V
CÓDIGO / CODE / CÓDIGO / CODE		2088.090	2088.092
<b>Preço / Prix / Precio / Price</b>	€	<b>1.423,00</b>	<b>1.491,00</b>
Dimensões / Dimensions / Dimensiones	mm	450x290x520	450x290x520
Produção / Production / Producción / Production	kg/h	250	250
Entrada carne / Entrée de la viande / Entrada de carne / Meat entrance	diam. (mm)	52	52
Peso Líquido-Bruto / Poids Net-Brut / Peso Neto-Bruto / Net-Gross Weight	kg	25-27	25-27
Potência / Puissance / Potencia / Power	kW/hp	1,1/1,5	1,1/1,5
Tensão / Tension / Tensión / Tension	V	400	230

MODELO / MODÈLE / MODELO / MODEL		22 C COM INVERSOR*	22 C COM INVERSOR*
CÓDIGO / CODE / CÓDIGO / CODE		2088.089	2088.088
<b>Preço / Prix / Precio / Price</b>	€	<b>1.711,00</b>	<b>1.779,00</b>
Dimensões / Dimensions / Dimensiones	mm	470x270x450	470x270x450
Produção / Production / Producción / Production	kg/h	300	300
Entrada carne / Entrée de la viande / Entrada de carne / Meat entrance	diam. (mm)	52	52
Peso Líquido-Bruto / Poids Net-Brut / Peso Neto-Bruto / Net-Gross Weight	kg	26-28	26-28
Potência / Puissance / Potencia / Power	kW/hp	1,1/1,5	1,1/1,5
Tensão / Tension / Tensión / Tension	V	400	230

MODELO / MODÈLE / MODELO / MODEL		TC32 CE INOX COM INVERSOR*	TC32 CE INOX COM INVERSOR*
CÓDIGO / CODE / CÓDIGO / CODE		2088.126	2088.126M
<b>Preço / Prix / Precio / Price</b>	€	<b>2.633,00</b>	<b>2.703,00</b>
Dimensões / Dimensions / Dimensiones	mm	470x300x450	470x300x450
Produção / Production / Producción / Production	kg/h	600	600
Entrada carne / Entrée de la viande / Entrada de carne / Meat entrance	diam. (mm)	52	-
Peso Líquido-Bruto / Poids Net-Brut / Peso Neto-Bruto / Net-Gross Weight	kg	43-44	43-44
Potência / Puissance / Potencia / Power	kW/hp	2,2/3	1,85/2,35
Tensão / Tension / Tensión / Tension	V	400	230



UDI

**MISTURADORES DE CARNE**

MIXEURS DE VIANDE

MEZCLADORES DE CARNES

MEAT MIXERS



Estrutura inteiramente em aço inox areado;  
Microinterruptor com tampa; Inversão de marcha;  
Botão de emergência; Levantamento da  
cuba (110°) para facilitar o esvaziamento; Pás  
removíveis; Kit de rodas (2 com travão) de série.



Corps entièrement en acier sablé;  
Microinterrupteur sur le couvercle; Inversion  
de marche; Bouton d'arrêt d'urgence; Cuve  
basculante (110°) pour faciliter le vidage;  
Lames amovibles; Kit route (dont 2 avec frein)  
de série.



Estructura completamente de acero inoxidable  
arenado; Microinterruptor con tapa; Inversión  
de la marcha; Botón de emergencia; El  
recipiente se puede volcar (110°) para facilitar  
su vaciado; Palas extraíbles; Kit de ruedas (2  
con freno) en el equipamiento de serie.



Sanded stainless steel structure; Micro switch  
on lid; Reverse function; Emergency stop  
button; Tank tilting (110°) for easy emptying;  
Removable blades; Wheel kit (2 of which with  
brake) as standard.



**NOVO**  
**NOUVEAU**  
**NUEVO**  
**NEW**



**Versão com duas pás**  
Versión con dos palas  
Version avec deux pelles  
Version with two paddles



**Versão com uma pá**  
Versión con una pala  
Version avec une pelle  
Version with one paddle

MODELO / MODÈLE / MODELO / MODEL		UDIMC30 1P 400V 25-30 KG	UDIMC30 1P 400V 25-30 KG	UDIMC50 1PN 400V 40-50 KG	UDIMC50 1PN 230V 40-50 KG	UDIMC50 2PN 400V 40-50 KG
CÓDIGO / CODE / CÓDIGO / CODE		2088.745A	2088.745	2088.746	2088.747	2088.748
<b>Preço / Prix / Precio / Price</b>	€	<b>4.280,00</b>	<b>4.222,00</b>	<b>4.741,00</b>	<b>4.799,00</b>	<b>7.396,00</b>
Dimensões / Dimensions / Dimensiones / Dimensions	mm	700x420x1020	700x420x1020	800x520x1020	800x520x1020	800x570x1040
Dimensões cuba / Dimensions cuve / Dimensiones cuba / Tank dimensions	mm	380x300x390	380x300x390	420x395x475	420x395x475	420x500x380
Pás / Pelle / Pala / Paddles	nr	1	1	1	1	2
Capacidade / Capacité / Capacidad / Capacity	kg	-	-	-	-	-
Capacidade trabalho / Capacité travail / Capacidad trabajo / Working capacity	kg/min	-	-	-	-	-
Capacidade da cuba / Capacité de la cuve / Capacidad de la cuba / Tank capacity	kg	25-30	25-30	25-50	25-50	25-50
Velocidade lâminas / Vitesse rotation pales / Blade rotation speed	rpm	30	30	30	30	23
Peso Líquido-Bruto / Poids Net-Brut / Peso Neto-Bruto / Net-Gross Weight	kg	49-58	49-58	80-97	80-97	80-90
Potência / Puissance / Potencia / Power	kw/hp	0,75/1	0,75/1	0,75/1	0,75/1	1,5/2
Tensão / Tension / Tensión / Tension	V	230	400	400	230	400

MODELO / MODÈLE / MODELO / MODEL		UDIMC75 1PN 400V 65-75 KG	UDIMC95 2PN 400V 85-95 KG	UDIMC115 2PN 400V 105-115 KG	UDIMC150 2PN 400V 140-150 KG
CÓDIGO / CODE / CÓDIGO / CODE		2088.749	2088.750	2088.751	2088.756
<b>Preço / Prix / Precio / Price</b>	€	<b>5.203,00</b>	<b>7.893,00</b>	<b>8.170,00</b>	<b>9.197,00</b>
Dimensões / Dimensions / Dimensiones	mm	980x520x1020	1160x570x1040	1100x630x1080	1260x630x1080
Dimensões cuba / Tank Dimensions / Dimensiones cuba / Vat Dimensions	mm	620x395x475	795x500x380	700x550x470	870x550x470
Pás / Pelle / Pas / Paddles	nr	1	2	2	2
Capacidade / Capacité / Capacidad / Capacité	kg	-	-	-	-
Capacidade trabalho / Capacité travail / Capacidad trabajo / Working capacity	kg/min	-	-	-	-
Capacidade da cuba / Tank capacity / Capacité de la cuve / Capacidad de la cuba	kg	35-75	50-95	50-115	50-150
Velocidade das lâminas / Blade rotation speed / Vitesse de rotation de pales /	rpm	30	30	30	30
Peso Líquido-Bruto / Poids Net-Brut / Peso Neto-Bruto / Net-Gross Weight	kg	85-102	110-127	110-127	115-135
Potência / Puissance / Potencia / Power	kw/hp	1,5/2	1,5/2	1,8/2,5	1,8/2,5
Tensão / Tension / Tensión / Tension	V	400	400	400	400



BT / HR - Funcionamento sincronizado de compressão e extração do hambúrguer através de uma alavanca manual. Manutenção mínima de fácil limpeza.



BT / HR - Fonctionnement synchronisé de compression et extraction de l'hamburger par un levier manuel. Maintenance minimale de nettoyage facile.



BT / HR - Funcionamiento sincronizado de compresión y extracción de la hamburguesa por una palanca manual. Mantenimiento mínimo de fácil limpieza.



BT / HR - Synchronized operation of compression and extraction of hamburger through a manual lever. Minimal maintenance easy to clean.



MODELO / MODÈLE / MODELO / MODEL CÓDIGO / CODE / CÓDIGO / CODE	PHI 10 4800.034	PHI13 4800.036
<b>Preço / Prix / Precio / Price</b>	€ <b>238,00</b>	€ <b>251,00</b>
Dimensões / Dimensions / Dimensiones	mm 320x250x300	mm 330x250x300
Diâm. Hambúrguer / Diam. Hamburger / Diam. Hamburger / Hamburguer diam.	Ømm 100	Ømm 130
Peso Líquido-Bruto / Poids Net-Brut / Peso Neto-Bruto / Net-Gross Weight	kg 5,2-6,5	kg 5,2-6,5



MODELO / MODÈLE / MODELO / MODEL CÓDIGO / CODE / CÓDIGO / CODE	HR 100 2101.005	HR 130 2101.006	HR 150 2101.006M
<b>Preço / Prix / Precio / Price</b>	€ <b>441,00</b>	€ <b>513,00</b>	€ <b>633,00</b>
Dimensões / Dimensions / Dimensiones	mm 250x260x500	mm 250x260x500	mm 250x260x500
Diâm. Hambúrguer / Diam. Hamburger / Diam. Hamburger / Hamburguer diam.	Ømm 100	Ømm 130	Ømm 150
Peso Líquido-Bruto / Poids Net-Brut / Peso Neto-Bruto / Net-Gross Weight	kg 5/6	kg 5,5-6,5	kg 6-7



MODELO / MODÈLE / MODELO / MODEL CÓDIGO / CODE / CÓDIGO / CODE	BT 10 CE 2086.160	BT 13 CE 2086.165	BT OVAL 2086.170
<b>Preço / Prix / Precio / Price</b>	€ <b>501,00</b>	€ <b>530,00</b>	€ <b>530,00</b>
Dimensões / Dimensions / Dimensiones	mm 160x220x300	mm 160x220x300	mm 160x220x300
Diâm. Hambúrguer / Diam. Hamburger / Diam. Hamburger / Hamburguer diam.	Ømm 100	Ømm 130	Ømm 180x80
Peso Líquido-Bruto / Poids Net-Brut / Peso Neto-Bruto / Net-Gross Weight	kg 5-6	kg 5-6	kg 5-6

11x8cm

Dim. Hambúrguer  
Dim. Hamburger  
Dim. Hamburger  
Hamburguer dim.



**PAPEL MÁQ. HAMBURGUER**

Cód.	Ref.	€
2086.172	1 KG BT 10	<b>61,00</b>
2086.174	1 KG BT 13	<b>61,00</b>
2086.176	1 KG BT OVAL	<b>61,00</b>
2101.006A	1 KG HR 150	<b>61,00</b>



opcional  
optionnel  
optional



manual  
manuel  
manual



confirmar disponibilidade  
confirmer la disponibilité  
confirmar la disponibilidad  
confirm the availability



UDI

**MÁQUINAS ENCHIDOS MANUAIS E ELÉTRICAS**  
**POUSSOI À SAUCISSES MANUELS ET ÉLECTRIQUES**  
**EMBUCHADORAS MANUALES Y ELÉCTRICAS**  
**MANUAL AND ELECTRICAL SAUSAGES FILLERS**



Máquinas manuais horizontais equipadas com 2 velocidades.  
 7L/14L - Cilindro em aço inoxidável AISI 304 18/8; Constituídas por duas engrenagens e equipadas com quatro funis mutáveis para diferentes tipos de salsichas.



Machines manuelles horizontales dotées de 2 vitesses.  
 7L/14L - Cylindre en acier inoxydable AISI 304 18/8; Constitué de deux engrenages et équipé de quatre entonnoirs interchangeables pour différents types de saucisses.



Máquinas manuales horizontales dotadas de 2 velocidades.  
 7L/14L - Cilindro de acero inoxidable AISI 304 18/8; Constituídas de dos engranajes y equipadas con cuatro embudos mutables para diferentes tipos de salchichas.



Manual horizontal machines equipped with 2 speeds.  
 7L/14L - Cylinder in 18/8 AISI 304 stainless steel; The sausage fillers have two gears and they are equipped with four changeable funnels for different kinds of sausages.



**SEMI-PRO**

MODELO / MODÈLE / MODELO / MODEL CÓDIGO / CODE / CÓDIGO / CODE		LT3 ECO 2088.104	LT5 2088.102
<b>Preço / Prix / Precio / Price</b>	€	<b>508,00</b>	<b>606,00</b>
Dimensões / Dimensions / Dimensiones	mm	220x370x200	590x230x240
Velocidade / Vitesse / Velocidad / Speed	cm/s	1	2
Capacidade / Capacité / Capacidad / Capacity	lt	3	5
Peso Líquido-Bruto / Poids Net-Brut / Peso Neto-Bruto / Net-Gross Weight	kg	8/11	11/14



MODELO / MODÈLE / MODELO / MODEL CÓDIGO / CODE / CÓDIGO / CODE		7L 2088.127	14L 2088.128
<b>Preço / Prix / Precio / Price</b>	€	<b>1.522,00</b>	<b>1.697,00</b>
Dimensões / Dimensions / Dimensiones	mm	300x250x710	350x350x880
Capacidade / Capacité / Capacidad / Capacity	lt	7	14
Velocidade / Vitesse / Velocidad / Speed	rpm	2	2
Peso Líquido-Bruto / Poids Net-Brut / Peso Neto-Bruto / Net-Gross Weight	kg	24,5/28	27/32



MODELO / MODÈLE / MODELO / MODEL CÓDIGO / CODE / CÓDIGO / CODE		24L 400V CE 2088.531	35L 400V CE 2088.532	50L 400V CE 2088.534
<b>Preço / Prix / Precio / Price</b>	€	<b>5.497,00</b>	<b>7.091,00</b>	<b>8.635,00</b>
Dimensões / Dimensions / Dimensiones	mm	520x570x1190	520x570x1190	520x570x1270
Capacidade / Capacité / Capacidad / Capacity	lt	24	35	50
Peso Líquido-Bruto / Poids Net-Brut / Peso Neto-Bruto / Net-Gross Weight	kg	120-140	130-150	155-175
Potência / Puissance / Potencia / Power	kw-hp	0,5-0,7	0,5-0,7	0,5-0,7
Tensão / Tension / Tensión / Tension	V	400	400	400



manual  
manuel  
manual



eléctrico  
électrique  
electric



confirmar disponibilidade  
confirmer la disponibilité  
confirmar la disponibilidad  
confirm the availability



Construídas com liga de alumínio anodizado. Funcionamento por correia. Lâmina fixada sobre rolamentos permite um deslizamento excepcional e possibilita cortar enchidos, assados, queijos, peixes, carnes duras e outros produtos. O regulador de espessura de corte de 0-16 mm é muito sensível e permite uma regulação decimal.



Construites en alliage d'aluminium anodisé. Opération par courroie. Lame montée sur roulements a un mouvement exceptionnellement coulant permettant ainsi de couper les saucissons volumineux, des rôtis, des fromages, du poisson, des viandes compactes, et d'autres produits. L'épaisseur des tranches est établie par un régulateur très sensible sur base décimale et peut varier de 0 à 16 mm.



Construídas con aleación de aluminio anodizado. Operación por correa. Cuchilla montada sobre rodamientos hace un deslizamiento excepcional y permite cortar embutidos pesados, asados, quesos, pescados, carnes duras y demás. El regulador del espesor de corte de 0 a 16 mm es muy sensible y permite la regulación decimal.



Built with anodized aluminium alloy. Belt operation. Blade mounted on ball bearings features exceptionally smooth running to cut heavy sausages, roasts, cheeses, fish, compact meat and other products. The decimal thickness regulator ranging between 0 and 16 mm is highly precise.



MODELO / MODÈLE / MODELO / MODEL		F195AF CE/D	220 A.F CE/D
CÓDIGO / CODE / CÓDIGO / CODE		2101.019	2101.020
Preço / Pri x / Precio / Price	€	678,00	753,00
Dimensões / Dimensions / Dimensiones	mm	360 x 520 x 315	405 x 580 x 340
Diâmetro lâmina / Diam. lame / Diám. cuchilla / Blade diam.	Ømm	195	220
Peso Líquido-Bruto / Poids Net-Brut / Peso Neto-Bruto / Net-Gross Weight	kg	10-11	13,5-15
Potência / Puissance / Potencia / Power	hp	0,20	0,25
Tensão / Tension / Tensión / Tension	V	230	230



MODELO / MODÈLE / MODELO / MODEL		F 250 A.F CE/D	F 275E CE/D	F 300E A.F CE/D
CÓDIGO / CODE / CÓDIGO / CODE		2101.021	2101.022	2101.023
Preço / Pri x / Precio / Price	€	906,00	951,00	1.272,00
Dimensões / Dimensions / Dimensiones	mm	425 x 620 x 370	440 x 620 x 390	495 x 650 x 440
Diâmetro lâmina / Diam. lame / Diám. cuchilla / Blade diam.	Ømm	250	275	300
Peso Líquido-Bruto / Poids Net-Brut / Peso Neto-Bruto / Net-Gross Weight	kg	15,5-18	16,5-18	23-25
Potência / Puissance / Potencia / Power	hp	0,30	0,30	0,35
Tensão / Tension / Tensión / Tension	V	230	230	230



MODELO / MODÈLE / MODELO / MODEL		F250R CE	F300R CE
CÓDIGO / CODE / CÓDIGO / CODE		2101.026	2101.028
Preço / Pri x / Precio / Price	€	801,00	1.125,00
Dimensões / Dimensions / Dimensiones	mm	405x 580x 370	485x 650x 440
Diâmetro lâmina / Diam. lame / Diám. cuchilla / Blade diam.	Ømm	250	300
Peso Líquido-Bruto / Poids Net-Brut / Peso Neto-Bruto / Net-Gross Weight	kg	14-17	19-25
Potência / Puissance / Potencia / Power	hp	0,25	0,33
Tensão / Tension / Tensión / Tension	V	230	230



MODELO / MODÈLE / MODELO / MODEL		275I IND. CE/P	300I IND. CE/P	F350 CE/P
CÓDIGO / CODE / CÓDIGO / CODE		2101.082	2101.084	2101.024
Preço / Pri x / Precio / Price	€	1.390,00	2.035,00	2.533,00
Dimensões / Dimensions / Dimensiones	mm	495 x 640 x 440	540 x 770 x 465	585 x 890 x 480
Diâmetro lâmina / Diam. lame / Diám. cuchilla / Blade diam.	Ømm	275	300	350
Peso Líquido-Bruto / Poids Net-Brut / Peso Neto-Bruto / Net-Gross Weight	kg	22	30	36
Potência / Puissance / Potencia / Power	hp	0,35	0,50	0,50
Tensão / Tension / Tensión / Tension	V	230	230	230



2101.032  
2101.034

2101.085

2101.025

MODELO / MODÈLE / MODELO / MODEL		F300E AF CE TEFLON	F 300E CE/P TEFLON	F300I TEFLON CE/P	F350 TEFLON CE/P
CÓDIGO / CODE / CÓDIGO / CODE		2101.032	2101.034	2101.085	2101.025
Preço / Pri x / Precio / Price	€	1.606,00	1.942,00	2.413,00	2.912,00
Dimensões / Dimensions / Dimensiones	mm	495x650x440	495x650x440	540x770x465	585x890x480
Diâmetro lâmina / Diam. lame / Diám. cuchilla / Blade diam.	Ømm	300	300	300	350
Peso Líquido-Bruto / Poids Net-Brut / Peso Neto-Bruto / Net-Gross Weight	kg	23	23	30	36
Potência / Puissance / Potencia / Power	hp	0,35	0,35	0,50	0,50
Tensão / Tension / Tensión / Tension	V	230	230	230	230

NOVO  
NOUVEAU  
NUEVO  
NEW

**Teflon é ideal para corte de queijo**  
**Téflon est idéal pour la découpe fromage**  
**Teflón es ideal para cortar queso**  
**Teflon is ideal for cutting cheese**





UDI

## CORTADORAS MANUAIS POR GRAVIDADE

TRANCHEUSES PAR GRAVITÉ MANUELLES

CORTADORAS POR GRAVEDAD MANUALES

MANUAL GRAVITY SLICERS



Construção em alumínio anodizado. Lâmina montada sobre rolamentos em esfera com deslizamento excepcional permitindo cortar salames pesados, assados, queijos, peixes, carnes duras etc.



Construction en aluminium anodisé. Lame montée sur des paliers à un mouvement exceptionnellement coulant permettant de trancher salames volumineux, rôties, romages, poissons, viandes dures etc



Construcción en aluminio anodizado. Cuchilla montada sobre cojinetes de esferas con deslizamiento excepcional que permite cortar embutidos pesados, asados, quesos, pescados, carnes duras y demás.



Made of anodized aluminium. Blade mounted on ball bearings features with exceptional sliding giving the possibility of cutting heavy sausages, roasts, cheeses, fish, hard meat and others.



MODELO / MODÈLE / MODELO / MODEL	ECO 220 CE/D 230V	
CÓDIGO / CODE / CÓDIGO / CODE	2086.505	
Preço / Prix / Precio / Price	€	732,00
Dimensões / Dimensions / Dimensiones	mm	500x420x370
Diâmetro lâmina / Diamètre lame / Diámetro cuchilla / Blade diameter	Ømm	220
Peso Bruto / Poids Brut / Peso Bruto / Gross Weight	kg	21
Potência / Puissance / Potencia / Power	hp	0,186
Tensão / Tension / Tensión / Tension	V	230



MODELO / MODÈLE / MODELO / MODEL	MAX 300 CE/BZ	
CÓDIGO / CODE / CÓDIGO / CODE	2086.545	
Preço / Prix / Precio / Price	€	3.451,00
Dimensões / Dimensions / Dimensiones	mm	720x520x520
Diâmetro lâmina / Diamètre lame / Diámetro cuchilla / Blade diameter	Ømm	300
Peso Bruto / Poids Brut / Peso Bruto / Gross Weight	kg	36
Potência / Puissance / Potencia / Power	hp	0,375
Tensão / Tension / Tensión / Tension	V	400



MODELO / MODÈLE / MODELO / MODEL	GL 300 CE	GL30E CE COM ELEMENTOS TEFLONADOS*	
CÓDIGO / CODE / CÓDIGO / CODE	2086.075	2086.077	
Preço / Prix / Precio / Price	€	2.543,00	3.052,00
Dimensões / Dimensions / Dimensiones	mm	580x630x460	580x630x460
Diâmetro lâmina / Diamètre lame / Diámetro cuchilla / Blade diameter	Ømm	300	300
Peso Bruto / Poids Brut / Peso Bruto / Gross Weight	kg	25	25
Potência / Puissance / Potencia / Power	hp	0,25-0,30	0,25-0,30
Tensão / Tension / Tensión / Tension	V	230	230



\*Lâmina + Vela + Resguardo = Teflon  
Lame + Bras + Protecteur = Teflon  
Cuchilla + Brazo + Barandilla = Teflon  
Teflon = Blade + Arm + Protection

Teflon é ideal para corte de queijo  
Téflon est idéal pour la découpe fromage  
Teflón es ideal para cortar queso  
Teflon is ideal for cutting cheese



confirmar disponibilidade  
confirmer la disponibilité  
confirmar la disponibilidad  
confirm the availability



Cortadoras automáticas por gravidade, movimento automático do carro porta-alimentos, com possibilidade de modificar a largura do corte em função do produto a cortar.



Trancheuses automatiques à gravité, avec mouvement automatique du chariot porte-charcuterie et avec la possibilité de régler la longueur de coupe en fonction des mesures du produit à rancher.



Cortadoras automáticas a gravidade, com movimento automático del carro porta-alimentos y con la posibilidad de modificar el ancho del corte en función del producto a cortar.



Gravity feed slicer models, with an automatic sliding product holder, with the possibility to modify the width of the cut depending on the product to be cut.

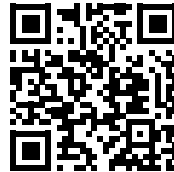

MODELO / MODÈLE / MODELO / MODEL		GLM 30E	GLM 30E TEFLON
CÓDIGO / CODE / CÓDIGO / CODE		2086.040	2086.042
<b>Preço / Prix / Precio / Price</b>	€	<b>6.291,00</b>	<b>6.800,00</b>
Dimensões / Dimensions / Dimensiones	mm	550x640x530	580x640x530
Diâmetro lâmina / Diamètre lame / Diámetro cuchilla / Blade diameter	Ømm	300	300
Peso Bruto / Poids Brut / Peso Bruto / Gross Weight	kg	41	41
Potência / Puissance / Potencia / Power	W	400	400
Tensão / Tension / Tensión / Tension	V	230	230



**GLM 30E  
(300) CE COM  
CONTADOR**  
2086.045



**GLM 30  
E CE COM  
CONTADOR E  
ELEMENTOS  
TEFLONADOS**  
\*

2086.046

Lâmina + Vela + Resguardo = Teflon\*  
 Lame + Bras + Protecteur = Teflon  
 Cuchilla + Brazo + Barandilla = Teflon  
 Teflon = Blade + Arm + Protection

MODELO / MODÈLE / MODELO / MODEL		GLM 30E (300) CE COM CONTADOR	GLM 30 E CE COM CONTADOR E ELEMENTOS TEFLONADOS *
CÓDIGO / CODE / CÓDIGO / CODE		2086.045	2086.046
<b>Preço / Prix / Precio / Price</b>	€	<b>6.896,00</b>	<b>8.089,00</b>
Dimensões / Dimensions / Dimensiones	mm	550x640x530	550x640x530
Diâmetro lâmina / Diamètre lame / Diámetro cuchilla / Blade diameter	Ømm	300	300
Peso Bruto / Poids Brut / Peso Bruto / Gross Weight	kg	41	41
Potência / Puissance / Potencia / Power	W	400	400
Tensão / Tension / Tensión / Tension	V	230	230



MODELO / MODÈLE / MODELO / MODEL		MATIC 350 CONTADOR E EMPILHADOR
CÓDIGO / CODE / CÓDIGO / CODE		2086.635
<b>Preço / Prix / Precio / Price</b>	€	<b>11.619,00</b>
Dimensões / Dimensions / Dimensiones	mm	650x790x620
Diâmetro lâmina / Diamètre lame / Diámetro cuchilla / Blade diameter	Ømm	350
Peso Bruto / Poids Brut / Peso Bruto / Gross Weight	kg	66
Potência / Puissance / Potencia / Power	W	375
Tensão / Tension / Tensión / Tension	V	400

**Teflon é ideal para corte de queijo**  
**Téflon est idéal pour la découpe fromage**  
**Teflón es ideal para cortar queso**  
**Teflon is ideal for cutting cheese**

 confirmar disponibilidade  
 confirmer la disponibilité  
 confirmar la disponibilidad  
 confirm the availability





UDI

**CORTADORAS VERTICAIS**  
**TRANCHEUSES VERTICALES**  
**CORTADORAS VERTICALES**  
**VERTICAL SLICERS**



Cortadoras verticais com características próprias, transmissão acionada por correia, ventilador de arrefecimento do motor, suporte para produtos de grandes dimensões se comparado com os modelos padrão, a fim de tornar esta cortadora ainda mais adequada a produtos volumosos e pesados.



Trancheuses verticales avec caractéristiques propres, transmission par courroie, ventilateur de refroidissement du moteur, support pour produits de grandes dimensions Par rapport à les modèles standards, afin de faire de cette trancheuse encore plus approprié pour les produits volumineux et lourds.



Cortadoras verticales con características propias, transmisión de correa, ventilador de refrigeración del motor, soporte para productos grandes en comparación con los modelos estándar, con el fin de hacer que esta cortadora se adecue más a los productos voluminosos y pesados..



Vertical slicers of essential design with belt driven transmission, fan cooled motor, oversized product holder if compared with standard models in order to make this slicer even more suitable for voluminous and weighty products.

Mercado externo  
Export market



MODELO / MODÈLE / MODELO / MODEL CÓDIGO / CODE / CÓDIGO / CODE		CORT. LUX 300P CE CARNE BZ 2086.582	EASY 350 CE CARNE BZ 2086.564
<b>Preço / Prix / Precio / Price</b>	€	<b>2.319,00</b>	<b>3.878,00</b>
Dimensões / Dimensions / Dimensiones	mm	550x590x500	630x700x560
Diâmetro lâmina / Diam. iame / Diám. cuchiiii / Blade diameter	Ømm	300	350
Peso Bruto / Poids Brut / Peso Bruto / Gross Weight	kg	30	49
Potência / Puissance / Potencia / Power	hp	0,3	0,35
Tensão / Tension / Tensión / Tension	V	230	400



MODELO / MODÈLE / MODELO / MODEL CÓDIGO / CODE / CÓDIGO / CODE		F300 TCV CE/P 2101.056	F350 TCV CE/P 2101.060
<b>Preço / Prix / Precio / Price</b>	€	<b>2.413,00</b>	<b>2.855,00</b>
Dimensões / Dimensions / Dimensiones	mm	550x710x550	650x820x640
Diâmetro lâmina / Diam. iame / Diám. cuchiiii / Blade diameter	Ømm	300	350
Peso Bruto / Poids Brut / Peso Bruto / Gross Weight	kg	34	43
Potência / Puissance / Potencia / Power	hp	0,5	0,5
Tensão / Tension / Tensión / Tension	V	230	230



MODELO / MODÈLE / MODELO / MODEL CÓDIGO / CODE / CÓDIGO / CODE		VP CFS N 2086.310	VP CFS NCS* 2086.306
<b>Preço / Prix / Precio / Price</b>	€	<b>1.705,00</b>	<b>1.388,00</b>
Dimensões / Dimensions / Dimensiones	mm	400x500x400	400x500x400
Diâmetro lâmina / Diam. iame / Diám. cuchiiii / Blade diameter	Ømm	300	300
Peso Bruto / Poids Brut / Peso Bruto / Gross Weight	kg	28	28
Potência / Puissance / Potencia / Power	hp	0,27	0,27
Tensão / Tension / Tensión / Tension	V	230	230

**Sólida construção em aço inox**  
**Solide construction en acier inox**  
**Solida construcción en acero inox**  
**Solid stain steel construction**



MODELO / MODÈLE / MODELO / MODEL CÓDIGO / CODE / CÓDIGO / CODE		V SVC 350 CE 2086.906
<b>Preço / Prix / Precio / Price</b>	€	<b>5.320,00</b>
Dimensões / Dimensions / Dimensiones	mm	530x810x510
Diâmetro lâmina / Diam. iame / Diám. cuchiiii / Blade diameter	Ømm	350
Peso Bruto / Poids Brut / Peso Bruto / Gross Weight	kg	57
Potência / Puissance / Potencia / Power	kW	-
Tensão / Tension / Tensión / Tension	V	400



MODELO / MODÈLE / MODELO / MODEL CÓDIGO / CODE / CÓDIGO / CODE		MEAT VERT. 300CE/BZ 2086.570	MEAT (EASY) VERT.370CE/BZ 2086.580
<b>Preço / Prix / Precio / Price</b>	€	<b>3.433,00</b>	<b>3.913,00</b>
Dimensões / Dimensions / Dimensiones	mm	580x680x480	750x790x520
Diâmetro lâmina / Diam. iame / Diám. cuchiiii / Blade diameter	Ømm	300	370
Peso Bruto / Poids Brut / Peso Bruto / Gross Weight	kg	40	53
Potência / Puissance / Potencia / Power	kW	0,37	0,5
Tensão / Tension / Tensión / Tension	V	230	400

confirmar disponibilidade  
 confirmer la disponibilité  
 confirmar la disponibilidad  
 confirm the availability



As cortadoras de volante vertical são as verdadeiras cortadoras de grande tradição, com todas as vantagens e facilidade, combinada com uma máquina moderna e um design contemporâneo.



Trancheuses à volant verticales sont la vraies trancheuses de grande tradition, avec tous les avantages et facilité, combinée avec une machine moderne et un design contemporain.



Las cortadoras verticales de volante son la verdaderas cortadoras de gran tradición, con todos los beneficios y la facilidad, en combinación con una máquina moderna y un diseño contemporáneo.



The vertical flywheel slicers are the main slicers of the delicatessen owner belonging to a great tradition, with all the advantages and ease combined with the charming aesthetic impact of a modern machine with a contemporary design.



COLUNA / COLONNE /  
 COLUMNA / COLUMN



MODELO / MODÈLE / MODELO / MODEL		300 CE	350 CE
CÓDIGO / CODE / CÓDIGO / CODE		2101.040	2101.042
Preço / Prix / Precio / Price	€	4.731,00	7.817,00
Dimensões / Dimensions / Dimensiones	mm	600x720x740	710x870x800
Peso Bruto / Poids Brut / Peso Bruto / Gross Weight	kg	45,5	81



MODELO / MODÈLE / MODELO / MODEL		COLUNA MOD.300	COLUNA MOD.350
CÓDIGO / CODE / CÓDIGO / CODE		2101.041	2101.043
Preço / Prix / Precio / Price	€	1.627,00	1.759,00
Dimensões / Dimensions / Dimensiones	mm	500x700	500x700
Peso Bruto / Poids Brut / Peso Bruto / Gross Weight	kg	45,7	45,7



MODELO / MODÈLE / MODELO / MODEL		300 CE BK
CÓDIGO / CODE / CÓDIGO / CODE		2101.036
Preço / Prix / Precio / Price	€	4.731,00
Dimensões / Dimensions / Dimensiones	mm	600x720x740
Peso Bruto / Poids Brut / Peso Bruto / Gross Weight	kg	45,5



MODELO / MODÈLE / MODELO / MODEL		COLUNA MOD.300
CÓDIGO / CODE / CÓDIGO / CODE		2101.037
Preço / Prix / Precio / Price	€	1.627,00
Dimensões / Dimensions / Dimensiones	mm	500x700
Peso Bruto / Poids Brut / Peso Bruto / Gross Weight	kg	45,7



opcional  
 optionnel  
 optional



manual  
 manuel  
 manual



Estrutura de aço inoxidável modelos 1860/2460/3160 lavável. Fáceis de utilizar e robustos com motores de grande potência. Resistentes à água para permitirem uma limpeza total. Comandos acessíveis. Equipados com os dispositivos de empurrar a carne e de porção, sistema de segurança mecânica e eléctrica.



Structure en acier inox modèles 1860/2460/3160 lavable. Facile à utiliser et robuste avec des moteurs de grande puissance. Résistant à l'eau pour permettre un nettoyage complet. Commandes accessibles. Équipés avec dispositifs de pousser la viande et portion, système de sécurité mécanique et électrique.



Estructura de acero inoxidable modelos 1860/2460/3160 lavable. Fáciles de usar y robusto con motores de gran potencia. Resistentes al agua para permitir una limpieza completa. Mandos accesibles. Equipado con dispositivos para empujar la carne y de porción, sistema de seguridad mecánica y eléctrica.



Stainless steel washable structure, 1860/2460/3160 models. Sturdy with high-power engines and easy to use. Water resistant to allow complete cleaning. Accessible controls. Equipped with pusher and portioning devices, security system mechanical and electrical.



MODELO / MODÈLE / MODELO / MODEL CÓDIGO / CODE / CÓDIGO / CODE		SO 1860 I CE 2088.502	SO1860I CE 2088.503	SO2460I CE 2088.505	SO 3160 I CE 2088.508
<b>Preço / Prix / Precio / Price</b>	€	<b>5.111,00</b>	<b>5.272,00</b>	<b>7.691,00</b>	<b>10.073,00</b>
Dimensões / Dimensions / Dimensiones	mm	510x500x970	510x550x1000	710x760x1710	850x935x1910
Comprimento Lâmina / Longueur lamme / Ancho Lâmina/ Blade length	mm	1860	1860x16	2460x20	3160
Altura do Corte / Hauteur de Coupe / Altura dei Corte / Cut height	mm	245	245	310	420
Largura do Corte / Largeur de Coupe / Ancho del Corte / Cut Width	mm	445	445	630	785
Plano de trabalho / Plan de travail / Plano de trabajo / Working table	mm	510x440	510x440	710x650	850x800
De coluna / De colonne / De column / Of column		-	-	-	√
Para bancada / Pour gradin / De sobremesa / For top range	mm	√	-	-	-
Peso Líquido / Poids Net / Peso Neto / Net Weight	kg	50	58-65	121-139	165
Potência / Puissance / Potencia / Power	kW	1,1	1,1	1,5	2,2
Tensão / Tension / Tensión / Tension	v	400	230	400	400



Anodizado  
Anodisé  
Anodizado  
Anodized

MODELO / MODÈLE / MODELO / MODEL CÓDIGO / CODE / CÓDIGO / CODE		1550 CE 2088.113	1550 CE 2088.112	1830 CE 2088.121	1830 CE 2088.122
<b>Preço / Prix / Precio / Price</b>	€	<b>2.591,00</b>	<b>2.661,00</b>	<b>2.703,00</b>	<b>2.769,00</b>
Dimensões / Dimensions / Dimensiones	mm	440x370x810	440x370x810	530x420x910	530x420x910
Altura do Corte / Hauteur de Coupe / Altura dei Corte / Cut height	mm	250	250	320	320
Largura Corte / Largeur Coupe / Ancho Corte / Cut Width	mm	170	170	200	200
Plano de trabalho / Plan de travail / Plano de trabajo / Working table	mm	330x330	330x330	410x410	410x410
Anodizados CE / Anodizés CE / Anodizados CE / CE Anodized		√	√	√	√
Peso Bruto / Poids Brut / Peso Bruto / Gross Weight	kg	34	34	38	38
Potência / Puissance / Potencia / Power	kW	0,75	0,75	0,75	0,75
Tensão / Tension / Tensión / Tension	v	400	230	400	230

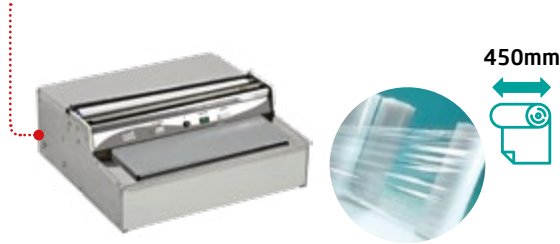

 Temperatura da placa / Température de la plaque °C 90  
 Temperatura de la placa / Plate temperature

 Temperatura de corte / Température de coupe °C 150  
 Temperatura de corte / Cutting temperature

 Moldes opcionais não incluídos / Moules optionnelles non inclus  
 Moldes opcionales no incluídos / Optional molds not included

MODELO / MODÈLE / MODELO / MODEL	UDEMB01
CÓDIGO / CODE / CÓDIGO / CODE	5200.050
<b>Preço / Prix / Precio / Price</b>	<b>€ 310,00</b>
Dimensões / Dimensions / Dimensiones	mm 550x520x250
Peso Líquido-Bruto / Poids Net-Brut / Peso Neto-Bruto / Net-Gross Weight	kg 7-12
Potência / Puissance / Potencia / Power	kW 0,17
Tensão / Tension / Tensión / Tension	V 230



MODELO / MODÈLE / MODELO / MODEL	SV300
CÓDIGO / CODE / CÓDIGO / CODE	2086.442
<b>Preço / Prix / Precio / Price</b>	<b>€ 1.659,00</b>
Dimensões / Dimensions / Dimensiones	mm 280x500x600
Dim. Máx. Container / Dim. Max. Container / Dim. Máx. Container / Máx. Container Dim.	mm 265x196
Peso Líquido-Bruto / Poids Net-Brut / Peso Neto-Bruto / Net-Gross Weight	kg 30-40
Potência / Puissance / Potencia / Power	kW 0,6
Tensão / Tension / Tensión / Tension	V 230



MODELO / MODÈLE / MODELO / MODEL	SV400
CÓDIGO / CODE / CÓDIGO / CODE	2086.444
<b>Preço / Prix / Precio / Price</b>	<b>€ 2.308,00</b>
Dimensões / Dimensions / Dimensiones	mm 400x500x600
Dim. Máx. Container / Dim. Max. Container / Dim. Máx. Container / Máx. Container Dim.	mm 265x325
Peso Líquido-Bruto / Poids Net-Brut / Peso Neto-Bruto / Net-Gross Weight	kg 45-55
Potência / Puissance / Potencia / Power	kW 1,2
Tensão / Tension / Tensión / Tension	V 230



MODELO / MODÈLE / MODELO / MODEL	VG600
CÓDIGO / CODE / CÓDIGO / CODE	2086.446
<b>Preço / Prix / Precio / Price</b>	<b>€ 10.000,00</b>
Dimensões / Dimensions / Dimensiones	mm 600x610x560
Dim. Máx. Container / Dim. Max. Container / Dim. Máx. Container / Máx. Container Dim.	mm 265x325
Bomba de vácuo / Pompe du vide / Bomba de vacío / Vacuum pompe	m3/h 20/24 m3/H-Oil
Dimensão Máx. Container / Dim. max. container / Dim. max. container / Max. container dim.	mm 265x325
Peso Líquido-Bruto / Poids Net-Brut / Peso Neto-Bruto / Net-Gross Weight	kg 90-100
Potência / Puissance / Potencia / Power	kW 1,8
Tensão / Tension / Tensión / Tension	V 230

 Inclui compressor silencioso para funções de vácuo e selagem  
 Comprend un compresseur silencieux pour les fonctions de vide et de scellement  
 Incluye compresor silencioso para funciones de vacío y sellado  
 Includes silent compressor for vacuum and seal functions

MODELO / MODÈLE / MODELO / MODEL	VG800
CÓDIGO / CODE / CÓDIGO / CODE	2086.448
<b>Preço / Prix / Precio / Price</b>	<b>€ 10.472,00</b>
Dimensões / Dimensions / Dimensiones	mm 600x600x1100
Dim. Máx. Container / Dim. Max. Container / Dim. Máx. Container / Máx. Container Dim.	mm 265x325
Bomba de vácuo / Pompe du vide / Bomba de vacío / Vacuum pompe	m3/h 20/24 m3/H-Oil
Dimensão Máx. Container / Dim. max. container / Dim. max. container / Max. container dim.	mm 265x325
Peso Líquido-Bruto / Poids Net-Brut / Peso Neto-Bruto / Net-Gross Weight	kg 140-150
Potência / Puissance / Potencia / Power	kW 1,8
Tensão / Tension / Tensión / Tension	V 230





**opcional**  
 optionnel  
 opcional  
 optional



UDI

**MÁQUINAS TERMOSELADORAS / VÁCUO - ACESSÓRIOS E OPCIONAIS**  
 MACHINES THERMOSCELLEUSES / VACUUM - ACCESSOIRES ET OPTIONNELS  
 MÁQUINAS TERMOSELLADORAS / VACÍO - ACCESORIOS Y OPCIONALES  
 THERMOSEALERS PACKERS / VACUUM - OPTIONALS AND SPARE PARTS



	CÓD.	MOD..	ACESSÓRIO / ACCESSOIRE / ACCESSORIO / ACCESSORIES	€
	2086.468	SV300	MOLDE MV (138X96) 2 CONTAINERS / MOULE MV (138X96) 2 CONTAINERS MOLDE MV (138X96) 2 CONTAINERS / MOULD MV (138X96) 2 CONTAINERS	CONSULTAR
	2086.469	SV300	MOLDE MV (193X138) 1 CONTAINER / MOULE MV (193X138) 1 CONTAINER MOLDE MV (193X138) 1 CONTAINER / MOULD MV (193X138) 1 CONTAINER	CONSULTAR
	2086.470	SV300	MOLDE MV (180X180) 1 CONTAINER / MOULE MV (180X180) 1 CONTAINER MOLDE MV (180X180) 1 CONTAINER / MOULD MV (180X180) 1 CONTAINER	CONSULTAR
	2086.471	SV300	MOLDE MV (195X260) 1 CONTAINER / MOULE MV (195X260) 1 CONTAINER MOLDE MV (195X260) 1 CONTAINER / MOULD MV (195X260) 1 CONTAINER	CONSULTAR
	2086.472 2086.479	SV400 VG600/VG800	MOLDE 1/2 GN (265X320) 1 CONTAINER / MOULE 1/2 GN (265X320) 1 CONTAINER / MOLDE 1/2 GN (265X320) 1 CONTAINER / MOULD 1/2 GN (265X320) 1 CONTAINER	CONSULTAR
	2086.473 2086.480	SV400 VG600/VG800	MOLDE 1/4 GN (265X160) 2 CONTAINERS / MOULE 1/4 GN (265X160) 2 CONTAINERS / MOLDE 1/4 GN (265X160) 2 CONTAINERS / MOULD 1/4 GN (265X160) 2 CONTAINERS	CONSULTAR
	2086.474 2086.481	SV400 VG600/VG800	MOLDE 1/8 GN (160X130) 4 CONTAINERS / MOULE 1/8 GN (160X130) 4 CONTAINERS / MOLDE 1/8 GN (160X130) 4 CONTAINERS / MOULD 1/8 GN (160X130) 4 CONTAINERS	CONSULTAR
	2086.445	VG600/VG800	BOMBA VERMELHA PARA TERMOSELADORA / POMPE ROUGE POUR MACHINE DE THER- MOSCELLAGE BOMBA ROJA PARA MÁQUINA TERMOSOLDADORA / RED PUMP FOR THERMOSEALING MACHINE	2.358,00
	2086.447	VG600/VG800	COMPRESSOR AR SILENCIOSO / COMPRESSEUR D'AIR SILENCIEUX COMPRESOR DE AIRE SILENCIOSO / SILENT AIR COMPRESSOR	683,00



Construídas em aço inoxidável. Controlos digitais. Adequados para embalar todo o tipo de produtos.



Construction en acier inoxydable. Commandes numériques. Convient pour emballer toutes sortes de produits.



Construidos en acero inoxidable. Mandos digitales. Apto para el envasado de todo tipo de productos.



Made of stainless steel. Digital controls. Suitable for packaging all kinds of products.

Opcionais não incluídos  
Options non incluses  
Opciones no incluidas  
Options not included



Opcionais não incluídos  
Options non incluses  
Opciones no incluidas  
Options not included



Opcionais não incluídos  
Options non incluses  
Opciones no incluidas  
Options not included



Opcionais não incluídos  
Options non incluses  
Opciones no incluidas  
Options not included



MODELO / MODÈLE / MODELO / MODEL CÓDIGO / CODE / CÓDIGO / CODE		ECO SMALL 2086.402
<b>Preço / Prix / Precio / Price</b>	€	<b>492,00</b>
Dimensões / Dimensions / Dimensiones	mm	370x280x170
Barra soldadura / Barre de soudure / Barra soldante / Sealing bar	mm	350
Bomba de vácuo / Pompe du vide / Bomba de vacío / Vacuum pompe	lt/min	20/24
Peso Líquido-Bruto / Poids Net-Brut / Peso Neto-Bruto / Net-Gross Weight	kg	8-9
Potência / Puissance / Potencia / Power	kW	0,25
Tensão / Tension / Tensión / Tension	V	230

MODELO / MODÈLE / MODELO / MODEL CÓDIGO / CODE / CÓDIGO / CODE		ECO ELIX 2086.404
<b>Preço / Prix / Precio / Price</b>	€	<b>592,00</b>
Dimensões / Dimensions / Dimensiones	mm	420x280x170
Barra soldadura / Barre de soudure / Barra soldante / Sealing bar	mm	400
Bomba de vácuo / Pompe du vide / Bomba de vacío / Vacuum pompe	lt/min	20/24
Peso Líquido-Bruto / Poids Net-Brut / Peso Neto-Bruto / Net-Gross Weight	kg	9-10
Potência / Puissance / Potencia / Power	kW	0,27
Tensão / Tension / Tensión / Tension	V	230

MODELO / MODÈLE / MODELO / MODEL CÓDIGO / CODE / CÓDIGO / CODE		ECO MEDIUM 2086.406
<b>Preço / Prix / Precio / Price</b>	€	<b>893,00</b>
Dimensões / Dimensions / Dimensiones	mm	520x280x170
Barra soldadura / Barre de soudure / Barra soldante / Sealing bar	mm	500
Bomba de vácuo / Pompe du vide / Bomba de vacío / Vacuum pompe	lt/min	40/48
Peso Líquido-Bruto / Poids Net-Brut / Peso Neto-Bruto / Net-Gross Weight	kg	12-13
Potência / Puissance / Potencia / Power	kW	0,35
Tensão / Tension / Tensión / Tension	V	230

MODELO / MODÈLE / MODELO / MODEL CÓDIGO / CODE / CÓDIGO / CODE		ECO PETIT 2086.410
<b>Preço / Prix / Precio / Price</b>	€	<b>905,00</b>
Dimensões / Dimensions / Dimensiones	mm	370x280x180
Barra soldadura / Barre de soudure / Barra soldante / Sealing bar	mm	350
Bomba de vácuo / Pompe du vide / Bomba de vacío / Vacuum pompe	lt/min	40/48
Peso Líquido-Bruto / Poids Net-Brut / Peso Neto-Bruto / Net-Gross Weight	kg	11-12
Potência / Puissance / Potencia / Power	kW	0,35
Tensão / Tension / Tensión / Tension	V	230

MODELO / MODÈLE / MODELO / MODEL CÓDIGO / CODE / CÓDIGO / CODE		ECO PROFIT 2086.412	ECO STAR 2086.414	ECO PLUS 2086.416
<b>Preço / Prix / Precio / Price</b>	€	<b>1.164,00</b>	<b>1.718,00</b>	<b>1.895,00</b>
Dimensões / Dimensions / Dimensiones	mm	420x310x180	470x380x210	520x380x210
Barra soldadura / Barre de soudure / Barra soldante / Sealing bar	mm	400	450	500
Bomba de vácuo / Pompe du vide / Bomba de vacío / Vacuum pompe	lt/min	40/48	8/9	8/9
Peso Líquido-Bruto / Poids Net-Brut / Peso Neto-Bruto / Net-Gross Weight	kg	13-14	22-30	23-30
Potência / Puissance / Potencia / Power	kW	0,15	0,15	0,35
Tensão / Tension / Tensión / Tension	V	230	230	230

Bolsa Ondulada / Sacs Ondulée / Sacos Ondulados / Waved Bags





UDI

**MÁQUINAS DE VÁCUO**  
MACHINES SOUS VIDE  
MÁQUINAS EMBALSADORAS DE VACÍO  
VACUUM PACKERS



Especial para produtos líquidos (atmosfera progressiva) ou produtos moles (gás inerte) permitindo embalar todo o tipo de produtos. Temporizador electrónico e painel de comando digital.



Special pour produits liquides (atmosphère progressive) ou produits mous (gaz inerte) permettant emballer tout genre de produits. Temporisateur électronique et panneau de commande digital.



Especial para productos líquidos (atmosfera progressiva) o productos moles (gás inerte) permitiendo embalar todo los tipos de productos. Temporizador electrónico y panel con mandos digitale.



Special for liquid products (progressive atmosphere) or soft items (inert gas), allowing packing all type of products. Electronic timer with digital control panel.



**ECO35**  
**2086.422**

Com programação  
With programming



**ECOFLEX 350MM**  
**2086.478**

Mecânica (não programa o tempo de vácuo)  
Mechanic (does not program the vacuum time)



**UNICA40**  
**2086.425**

Mecânica (não programa o tempo de vácuo)  
Mechanic (does not program the vacuum time)



**ECO40**    **ECO40 + GÁS**  
**2086.426**    **2086.427**



**ECO25**  
**2086.418**

**ECO30**  
**2086.420**

**ECO45**  
**2086.428**



**ECO50 SUPER**  
**2086.432A**



MODELO / MODÈLE / MODELO / MODEL		ECO25	ECOFLEX 350MM	ECO30	UNICA40	ECO35	ECO40	ECO45	ECO40 + GÁS	ECO50 SUPER
CÓDIGO / CODE / CÓDIGO / CODE		2086.418	2086.478	2086.420	2086.425	2086.422	2086.426	2086.428	2086.427	2086.432A
<b>Preço / Prix / Precio / Price</b>	€	<b>2.320,00</b>	<b>2.662,00</b>	<b>2.721,00</b>	<b>2.942,00</b>	<b>3.016,00</b>	<b>3.641,00</b>	<b>4.230,00</b>	<b>4.112,00</b>	<b>4.785,00</b>
Dimensões / Dimensions / Dimensiones	mm	360 x 430 x 400	420 x 530 x 400	410 x 490 x 420	510 x 560 x 450	460 x 530 x 420	510 x 590 x 450	560 x 640 x 450	510 x 590 x 450	620 x 630 x 450
Barra soldadura / Barre de soudure / Barra soldante / Sealing bar"	mm	250	350	300	400	350	400	450	400	500
Bomba de vácuo / Pompe du vide / Bomba de vacío / Vacuum pompe	m <sup>3</sup> /h	6m <sup>3</sup> /H-Oil	8/9.6m <sup>3</sup> /H-Oil	8/9.6m <sup>3</sup> /H-Oil	12/14.4m <sup>3</sup> /H-Oil	8/9.6m <sup>3</sup> /H-Oil	20/24m <sup>3</sup> /H-Oil	20/24m <sup>3</sup> /H-Oil	20/24m <sup>3</sup> /H-Oil	20-24 m <sup>3</sup> /H-Oil
Dimensões Câmara / Dimensions Chambre / Dimensiones Cámara / Chamber Dimensions	mm	260 x 300 x 160	360 x 400 x 190	310 x 350 x 190	410 x 450 x 220	360 x 400 x 190	410 x 450 x 220	460 x 500 x 220	410 x 450 x 220	520 x 520 x 220
Peso Líquido-Bruto / Poids Net-Brut / Peso Neto-Bruto / Net-Gross Weight	kg	32-40	40-50	38-50	50-60	40-50	55-65	60-70	55-65	80-90
Potência / Puissance / Potencia / Power	kW	0,35	0,45	0,40	0,90	0,45	0,90	0,90	0,90	0,90
Tensão / Tension / Tensión / Tension	v	230	230	230	230	230	230	230	230	230

Bolsas Lisas / Sacs Lisse / Sacos Lisos / Flat Bags

OPCIONAIS / OPTIONNELLES / OPCIONALES / OPTIONALS 133



confirmar disponibilidade  
confirmer la disponibilité  
confirmar la disponibilidad  
confirm the availability



Mod. UDI 430 - Possui um plano de trabalho e uma tampa totalmente transparente. A soldadura é feita através de pistões pneumáticos.



Mod. UDI 430 - Avoir un plan de travail et un couvercle entièrement transparent. Le soudage est effectué par des pistons pneumatiques.



Mod. UDI 430 - Tiene un plano de trabajo y la tapa totalmente transparente. La soldadura es a través de pistones neumáticos.



Mod. UDI 430 - Have a work plan and a lid fully transparent. The welding is done by pneumatic pistons.



BOLSAS / SACS / SACOS / BAGS



MODELO / MODÈLE / MODELO / MODEL	UDI 430
CÓDIGO / CODE / CÓDIGO / CODE	2086.456
<b>Preço / Prix / Precio / Price</b>	<b>€ 3.449,00</b>
Dimensões / Dimensions / Dimensiones	mm 450x450x180
Barra soldadura / Barre de soudure / Barra soldante / Sealing bar	mm 430
Bomba de vácuo / Pompe du vide / Bomba de vacío / Vacuum pompe	m <sup>3</sup> /h 12m <sup>3</sup> /H-Oil
Dimensões Câmara / Dimensions Chambre / Dimensiones Cámara / Chamber Dimensions	mm -
Peso Líquido-Bruto / Poids Net-Brut / Peso Neto-Bruto / Net-Gross Weight	kg 50
Potência / Puissance / Potencia / Power	kW 0,35
Tensão / Tension / Tensión / Tension	V 230



MODELO / MODÈLE / MODELO / MODEL	ECOTYPE 250MM
CÓDIGO / CODE / CÓDIGO / CODE	2086.476
<b>Preço / Prix / Precio / Price</b>	<b>€ 2.013,00</b>
Dimensões / Dimensions / Dimensiones	mm 320 x 500 x 270
Barra soldadura / Barre de soudure / Barra soldante / Sealing bar	mm 250
Bomba de vácuo / Pompe du vide / Bomba de vacío / Vacuum pompe	m <sup>3</sup> /h 6m <sup>3</sup> /H-Oil
Dimensões Câmara / Dimensions Chambre / Dimensiones Cámara / Chamber Dimensions	mm 260 x 300 x 110
Peso Líquido-Bruto / Poids Net-Brut / Peso Neto-Bruto / Net-Gross Weight	kg 30-40
Potência / Puissance / Potencia / Power	kW 0,35
Tensão / Tension / Tensión / Tension	V 230



MODELO / MODÈLE / MODELO / MODEL	UNIVERSAL 30
CÓDIGO / CODE / CÓDIGO / CODE	2086.419
<b>Preço / Prix / Precio / Price</b>	<b>€ 2.337,00</b>
Dimensões / Dimensions / Dimensiones	mm 370 x 530 x 250
Barra soldadura / Barre de soudure / Barra soldante / Sealing bar	mm 300
Bomba de vácuo / Pompe du vide / Bomba de vacío / Vacuum pompe	m <sup>3</sup> /h 6m <sup>3</sup> /H-Oil
Dimensões Câmara / Dimensions Chambre / Dimensiones Cámara / Chamber Dimensions	mm 310 x 350 x 120
Peso Líquido-Bruto / Poids Net-Brut / Peso Neto-Bruto / Net-Gross Weight	kg 32-40
Potência / Puissance / Potencia / Power	kW 0,35
Tensão / Tension / Tensión / Tension	V 230



UDI

**MÁQUINAS DE VÁCUO**  
MACHINES SOUS VIDE  
MÁQUINAS DE VACÍO  
VACUUM PACKERS



Especial para produtos líquidos (atmosfera progressiva) ou produtos moles (gás inerte) permitindo embalar todo o tipo de produtos. Temporizador electrónico e painel de comando digital.



Special pour produits liquides (atmosphère progressive) ou produits mous (gaz inerte) permettant emballer tout genre de produits. Temporisateur électronique et panneau de commande digital.



Especial para productos líquidos (atmosfera progressiva) o productos moles (gás inerte) permitiendo embalar todo los tipos de productos. Temporizador electrónico y panel con mandos digitale.



Special for liquid products (progressive atmosphere) or soft items (inert gas), allowing packing all type of products. Electronic timer with digital control panel.



MODELO / MODÈLE / MODELO / MODEL	ECO45L	
CÓDIGO / CODE / CÓDIGO / CODE	2086.436	
<b>Preço / Prix / Precio / Price</b>	€	<b>5.292,00</b>
Dimensões / Dimensions / Dimensiones	mm	560x640x1050
Barra soldadura / Barre de soudure / Barra soldante / Sealing bar	mm	450
Bomba de vácuo / Pompe du vide / Bomba de vacio / Vacuum pompe	m <sup>3</sup> /h	20/24m <sup>3</sup> /H-Oil
Dimensões Câmara / Dimensions Chambre / Dimensiones Cámara / Chamber Dimensions	mm	460x500x220
Peso Líquido-Bruto / Poids Net-Brut / Peso Neto-Bruto / Net-Gross Weight	kg	100-110
Potência / Puissance / Potencia / Power	kW	0,9
Tensão / Tension / Tensión / Tension	V	230



MODELO / MODÈLE / MODELO / MODEL	ECO 45 BIS	
CÓDIGO / CODE / CÓDIGO / CODE	2086.438	
<b>Preço / Prix / Precio / Price</b>	€	<b>6.011,00</b>
Dimensões / Dimensions / Dimensiones	mm	680x600x1050
Barra soldadura / Barre de soudure / Barra soldante / Sealing bar	mm	2x450
Bomba de vácuo / Pompe du vide / Bomba de vacio / Vacuum pompe	m <sup>3</sup> /h	20/24m <sup>3</sup> /H-Oil
Dimensões Câmara / Dimensions Chambre / Dimensiones Cámara / Chamber Dimensions	mm	560x460x220
Peso Líquido-Bruto / Poids Net-Brut / Peso Neto-Bruto / Net-Gross Weight	kg	110-120
Potência / Puissance / Potencia / Power	kW	0,9
Tensão / Tension / Tensión / Tension	V	230



MODELO / MODÈLE / MODELO / MODEL	ECO 55 BIS	
CÓDIGO / CODE / CÓDIGO / CODE	2086.440	
<b>Preço / Prix / Precio / Price</b>	€	<b>8.558,00</b>
Dimensões / Dimensions / Dimensiones	mm	840x710x1050
Barra soldadura / Barre de soudure / Barra soldante / Sealing bar	mm	2x550
Bomba de vácuo / Pompe du vide / Bomba de vacio / Vacuum pompe	m <sup>3</sup> /h	60/72m <sup>3</sup> /H-Oil
Dimensões Câmara / Dimensions Chambre / Dimensiones Cámara / Chamber Dimensions	mm	720x570x220
Peso Líquido-Bruto / Poids Net-Brut / Peso Neto-Bruto / Net-Gross Weight	kg	160-170
Potência / Puissance / Potencia / Power	kW	1,45
Tensão / Tension / Tensión / Tension	V	400



MODELO / MODÈLE / MODELO / MODEL	ECO 90 BIS	
CÓDIGO / CODE / CÓDIGO / CODE	2086.441	
<b>Preço / Prix / Precio / Price</b>	€	<b>10.917,00</b>
Dimensões / Dimensions / Dimensiones	mm	1040x710x1050
Barra soldadura / Barre de soudure / Barra soldante / Sealing bar	mm	900/500
Bomba de vácuo / Pompe du vide / Bomba de vacio / Vacuum pompe	m <sup>3</sup> /h	100-120m <sup>3</sup> /H-Oil
Dimensões Câmara / Dimensions Chambre / Dimensiones Cámara / Chamber Dimensions	mm	920x570x220
Peso Líquido-Bruto / Poids Net-Brut / Peso Neto-Bruto / Net-Gross Weight	kg	200-210
Potência / Puissance / Potencia / Power	kW	2,4
Tensão / Tension / Tensión / Tension	V	400

OPCIONAIS / OPTIONNELLES / OPCIONALES / OPTIONALS 133



Câmara em inox com ângulos internos arredondados. Ideais para acondicionar diferentes produtos (enchidos, queijos, café, etc.). Temporizador eletrônico e painel de comandos digital. Máquinas de vácuo de grandes dimensões ideais para indústrias, permitindo embalar todo o tipo de produtos.



Chambre inox avec angles intérieurs arrondis. Idéaux pour conditionner différents produits (embouti, fromages, café, etc.). Temporisateur électronique et panneau de commandes digitales. Machines à vacuum de grandes dimensions idéales pour l'industries permettant emballer tout genre de produits.



Câmara em aço inoxidável com ângulos internos arredondados. Ideais para acondicionar diferentes productos (embutidos, queso, café, etc.). Temporizador electrónico e painel con mandos digitales. Máquinas de vacío de grandes dimensiones, permitiendo embalar todo o tipo de productos.



Stainless steel chamber whit internal round edges. The right choice to package diferent products (salami, cheese, coffe, etc.). Electronic timer with digital control panel. Packers of great dimensions for industries, allowing all type of products.



MODELO / MODÈLE / MODELO / MODEL CÓDIGO / CODE / CÓDIGO / CODE	TOP 2086.460	
<b>Preço / Prix / Precio / Price</b>	€	<b>CONSULTAR</b>
Dimensões / Dimensions / Dimensiones	mm	570x660x530
Barra soldadura / Barre de soudure / Barra soldante / Sealing bar	mm	450
Bomba de vácuo / Pompe du vide / Bomba de vacío / Vacuum pompe	m3/h	20/24 m3/H-Oil
Dimensões Câmara / Dimensions Chambre / Dimensiones Cámara / Chamber Dimensions	mm	470x530x220
Peso Líquido-Bruto / Poids Net-Brut / Peso Neto-Bruto / Net-Gross Weight	kg	90-100
Potência / Puissance / Potencia / Power	kW	0,9
Tensão / Tension / Tensión / Tension	v	230



MODELO / MODÈLE / MODELO / MODEL CÓDIGO / CODE / CÓDIGO / CODE	ULTRA 2086.462	
<b>Preço / Prix / Precio / Price</b>	€	<b>CONSULTAR</b>
Dimensões / Dimensions / Dimensiones	mm	760x670x1150
Barra soldadura / Barre de soudure / Barra soldante / Sealing bar	mm	2X(500)
Bomba de vácuo / Pompe du vide / Bomba de vacío / Vacuum pompe	m3/h	60/72 m3/H-Oil
Dimensões Câmara / Dimensions Chambre / Dimensiones Cámara / Chamber Dimensions	mm	660x530x230
Peso Líquido-Bruto / Poids Net-Brut / Peso Neto-Bruto / Net-Gross Weight	kg	160-240
Potência / Puissance / Potencia / Power	kW	1,3
Tensão / Tension / Tensión / Tension	v	400



MODELO / MODÈLE / MODELO / MODEL CÓDIGO / CODE / CÓDIGO / CODE	MEGA 2086.464	
<b>Preço / Prix / Precio / Price</b>	€	<b>CONSULTAR</b>
Dimensões / Dimensions / Dimensiones	mm	900x800x1150
Barra soldadura / Barre de soudure / Barra soldante / Sealing bar	mm	2x(600)
Bomba de vácuo / Pompe du vide / Bomba de vacío / Vacuum pompe	m3/h	100/120 m3/H-Oil
Dimensões Câmara / Dimensions Chambre / Dimensiones Cámara / Chamber Dimensions	mm	830x660x230
Peso Líquido-Bruto / Poids Net-Brut / Peso Neto-Bruto / Net-Gross Weight	kg	220-310
Potência / Puissance / Potencia / Power	kW	2,4
Tensão / Tension / Tensión / Tension	v	400



MODELO / MODÈLE / MODELO / MODEL CÓDIGO / CODE / CÓDIGO / CODE	JUMBO 2086.466	
<b>Preço / Prix / Precio / Price</b>	€	<b>CONSULTAR</b>
Dimensões / Dimensions / Dimensiones	mm	1150x800x1150
Barra soldadura / Barre de soudure / Barra soldante / Sealing bar	mm	1000/550
Bomba de vácuo / Pompe du vide / Bomba de vacío / Vacuum pompe	m3/h	110/120 m3/H-Oil
Dimensões Câmara / Dimensions Chambre / Dimensiones Cámara / Chamber Dimensions	mm	1050x660x230
Peso Líquido-Bruto / Poids Net-Brut / Peso Neto-Bruto / Net-Gross Weight	kg	250-380
Potência / Puissance / Potencia / Power	kW	2,5
Tensão / Tension / Tensión / Tension	v	400



UDI

**MÁQUINAS DE VÁCUO - ACESSÓRIOS E OPCIONAIS**

MACHINES SOUS VIDE - ACCESSOIRES ET OPTIONNELS

MÁQUINAS DE VACÍO - ACCESORIOS Y OPCIONALES

VACUUM PACKERS - OPTIONALS AND SPARE PARTS



**OPCIONAL INJEÇÃO DE GÁS INERTE / OPTIONNEL INJECTION DE GAZ INERTE / OPCIONAL INYECCIÓN DE GAS INERTE / INJECTION OF INERT GAS OPTIONAL**

**MÁQUINAS VÁCUO / MACHINNES POUR CONDITIONNEMENT SOUS VIDE / MÁQUINAS DE VACÍO / VACUUM MACHINES**

Cód.	€
2086.424	472,00

**BOLSAS LISAS (100 UN) / SACS LISSE (100 UN) / SACOS LISOS (100 UN) / FLAT BAGS (100 UN)**

**MÁQUINAS VÁCUO / MACHINNES POUR CONDITIONNEMENT SOUS VIDE / MÁQUINAS DE VACÍO / VACUUM MACHINES**



Cód.	Altura / Hauteur / Height (mm)	€
2086.455L1B	150x250	27,00
2086.455L22	150x350	30,00
2086.455L10	300X400	55,00
2086.455L11	350X450	67,00
2086.455L12	400X500	84,00
2086.455L14	400X600	97,00
2086.455L18	500X700	134,00
2086.455L2	200X300	31,00
2086.455L4	200X400	38,00
2086.455L5	200X600	59,00
2086.455L7	250X350	42,00

**BOLSA ONDULADA (100 UN) / SACS ONDULÉE (100 UN) / SACOS ONDULADOS (100 UN) / WAVED BAGS (100 UN)**

**MÁQUINAS VÁCUO / MACHINNES POUR CONDITIONNEMENT SOUS VIDE / MÁQUINAS DE VACÍO / VACUUM MACHINES**



Cód.	Altura / Hauteur / Height (mm)	€
2086.45501A	150x250	31,00
2086.455010	300X400	62,00
2086.455011	350X450	78,00
2086.455012	400X500	97,00
2086.455014	400X600	109,00
2086.455018	500X700	155,00
2086.45502	200X300	45,00
2086.45504	200X400	42,00
2086.45505	200X600	70,00
2086.45507	250X350	49,00



Temperatura controlada de forma precisa  
Circulação consistente da água  
Alimentos perfeitamente cozidos  
É fácil de utilizar  
Preserva as propriedades organolépticas dos produtos  
Reduz a desidratação dos alimentos  
Melhora o armazenamento de longo prazo dos alimentos  
Facilita o planeamento na cozinha



Pour cuire les produits emballés dans des sacs à vide  
Température précisément contrôlée  
Circulation de l'eau cohérente  
Aliment cuit parfaitement bout à bout  
Facile à utiliser  
Préserve les propriétés organoleptiques du produit  
Réduit la déshydratation des aliments  
Améliore le stockage à long terme  
Facilite la planification dans la cuisine



Para cocinar productos envasados en bolsas de vacío  
Temperatura precisamente controlada  
Circulación de agua constante  
Alimentos perfectamente cocidos de extremo a extremo  
Fácil de usar  
Conserva las propiedades organolépticas del producto  
Reduce la deshidratación de los alimentos  
Mejora el almacenamiento de alimentos a largo plazo  
Facilita la planificación en la cocina



Cooks products packed in vacuum bags  
Precisely controlled temperature  
Circulation consistent water  
Perfectly cooked food end-to-end  
Easy to use  
Preserves the organoleptic properties of the product  
Reduces dehydration of food  
Improves long-term food storage  
Facilitates kitchen planning

**1/1**

MODELO / MODÈLE / MODELO / MODEL	MAQ. COZ. VACUO	
CÓDIGO / CODE / CÓDIGO / CODE	2086.458	
<b>Preço / Prix / Precio / Price</b>	<b>€</b>	<b>1.468,00</b>
Dimensões / Dimensions / Dimensiones	mm	350x550x320
Capacidade máxima da cuba / Capacité maximale de la cuve / Capacidad máxima de la cuba / Vat maximum capacity	lt	25
Temperatura de trabalho / Température de travail / Temperatura de trabajo / Working temperature	°C	45/100
Peso Líquido-Bruto / Poids Net-Brut / Peso Neto-Bruto / Net-Gross Weight	kg	12-20
Potência / Puissance / Potencia / Power	kW	1
Tensão / Tension / Tensión / Tension	V	230

**1/2**

MODELO / MODÈLE / MODELO / MODEL	SV200	
CÓDIGO / CODE / CÓDIGO / CODE	2086.459	
<b>Preço / Prix / Precio / Price</b>	<b>€</b>	<b>1.129,00</b>
Dimensões / Dimensions / Dimensiones	mm	345x285x270
Capacidade máxima da cuba / Capacité maximale de la cuve / Capacidad máxima de la cuba / Vat maximum capacity	lt	9
Temperatura de trabalho / Température de travail / Temperatura de trabajo / Working temperature	°C	45/100
Peso Líquido-Bruto / Poids Net-Brut / Peso Neto-Bruto / Net-Gross Weight	kg	6,5-10
Potência / Puissance / Potencia / Power	kW	0,4
Tensão / Tension / Tensión / Tension	V	230

\* Containers de 5 a 22 litros / Cuves de 5 à 22 litres / Cuba de 5 a 22 litros / Containers from 5 to 22 litres.



UDI

**BANHOS-MARIA**  
BAINS-MARIE  
BAÑOS MARÍA  
BAIN-MARIES



Ao cozinhar com o Banho-Maria os alimentos não entram em contacto com a fonte de calor (resistência por baixo do container). Os alimentos são cozidos ou mantidos quentes devido à temperatura da água que se mantém a 90°C. Os modelos BM SOUPE foram especialmente desenhados para sopa.



Dans la cuisson au bain-marie, les aliments ne sont pas au contact de la source de chaleur (résistance sous le bac) mais cuisent ou restent à température grâce au bain d'eau maintenu à 90°C. Les modèles BM SOUPE ont été spécialement conçu pour soupe.



Los alimentos cocinados con el Baño María no entran en contacto con la fuente de calor (resistencia debajo del envase). Puede cocinar o mantener calientes los alimentos debido a la temperatura de la agua que se mantiene a 90°C. Los modelos BM SOUPE han sido diseñados especialmente para la sopa.



When cooking with a Bain-Marie, food does not come into contact with the heat source (heating element underneath the container) but is cooked or kept warm thanks to the water maintained at 90°C. BM SOUPE models were specially design for soupe.



MODELO / MODÈLE / MODELO / MODEL CÓDIGO / CODE / CÓDIGO / CODE		UDPS PRETA 5200.122
<b>Preço / Prix / Precio / Price</b>	€	<b>293,00</b>
Dimensões / Dimensions / Dimensiones	mm	360x400x200
Capacidade / Capacidad / Capacité / Capacidad / Capacity	lt	8
Peso Bruto / Poids Brut / Peso Bruto / Gross Weight	kg	7
Potência / Puissance / Potencia / Power	kW	0,4
Tensão / Tension / Tensión / Tension	V	230



MODELO / MODÈLE / MODELO / MODEL CÓDIGO / CODE / CÓDIGO / CODE		UDPS INOX 5200.124
<b>Preço / Prix / Precio / Price</b>	€	<b>373,00</b>
Dimensões / Dimensions / Dimensiones	mm	360x355x200
Capacidade / Capacidad / Capacité / Capacidad / Capacity	lt	10
Peso Bruto / Poids Brut / Peso Bruto / Gross Weight	kg	7
Potência / Puissance / Potencia / Power	kW	0,4
Tensão / Tension / Tensión / Tension	V	230



MODELO / MODÈLE / MODELO / MODEL CÓDIGO / CODE / CÓDIGO / CODE		UMB 1/1 150 3010.048
<b>Preço / Prix / Precio / Price</b>	€	<b>299,00</b>
Dimensões / Dimensions / Dimensiones	mm	340x600x300
Capacidade / Capacidad / Capacité / Capacidad / Capacity	GN	1/1 - 150mm ↓
Peso Bruto / Poids Brut / Peso Bruto / Gross Weight	kg	3
Potência / Puissance / Potencia / Power	kW	1,5
Tensão / Tension / Tensión / Tension	V	230



MODELO / MODÈLE / MODELO / MODEL CÓDIGO / CODE / CÓDIGO / CODE		UMB 1/1 150 3010.050
<b>Preço / Prix / Precio / Price</b>	€	<b>363,00</b>
Dimensões / Dimensions / Dimensiones	mm	340x600x300
Capacidade / Capacidad / Capacité / Capacidad / Capacity	GN	1/1 - 150mm ↓
Peso Bruto / Poids Brut / Peso Bruto / Gross Weight	kg	3
Potência / Puissance / Potencia / Power	kW	1,5
Tensão / Tension / Tensión / Tension	V	230

Sem containers e tampa  
Sans containers et couvercles  
Sin containers e tapas  
Without containers and covers



MODELO / MODÈLE / MODELO / MODEL CÓDIGO / CODE / CÓDIGO / CODE		UMB 1/1 D 150 3010.052
<b>Preço / Prix / Precio / Price</b>	€	<b>586,00</b>
Dimensões / Dimensions / Dimensiones	mm	685x600x300
Capacidade / Capacidad / Capacité / Capacidad / Capacity	GN	2 x 1/1 - 150mm ↓
Peso Bruto / Poids Brut / Peso Bruto / Gross Weight	kg	6
Potência / Puissance / Potencia / Power	kW	3
Tensão / Tension / Tensión / Tension	V	230



MODELO / MODÈLE / MODELO / MODEL CÓDIGO / CODE / CÓDIGO / CODE		UMB 1/1 D 150 TAP 3010.054
<b>Preço / Prix / Precio / Price</b>	€	<b>673,00</b>
Dimensões / Dimensions / Dimensiones	mm	685x600x300
Capacidade / Capacidad / Capacité / Capacidad / Capacity	GN	2 x 1/1 - 150mm ↓
Peso Bruto / Poids Brut / Peso Bruto / Gross Weight	kg	6,4
Potência / Puissance / Potencia / Power	kW	3
Tensão / Tension / Tensión / Tension	V	230



confirmar disponibilidade  
confirmer la disponibilité  
confirmar la disponibilidad  
confirm the availability



MODELO / MODÈLE / MODELO / MODEL	UC06 INOX	
CÓDIGO / CODE / CÓDIGO / CODE	3010.046	
<b>Preço / Prix / Precio / Price</b>	<b>€</b>	<b>314,00</b>
Dimensões / Dimensions / Dimensiones	mm	340x310x290
Peso Bruto / Poids Brut / Peso Bruto / Gross Weight	kg	5,2
Potência / Puissance / Potencia / Power	kW	1,2
Tensão / Tension / Tensión / Tension	v	230



MODELO / MODÈLE / MODELO / MODEL	CU2077	
CÓDIGO / CODE / CÓDIGO / CODE	2089.015	
<b>Preço / Prix / Precio / Price</b>	<b>€</b>	<b>1.058,00</b>
Dimensões / Dimensions / Dimensiones	mm	270x360x290
Peso Bruto / Poids Brut / Peso Bruto / Gross Weight	kg	6
Potência / Puissance / Potencia / Power	kW	1,85
Tensão / Tension / Tensión / Tension	v	230





UDI

**ESCALDA BATATAS / PLANOS AQUECIDOS**  
**CHAUFFE POMMES DE TERRE / PLANS CHAUFFÉS**  
**ESCALDA PATATAS / PLANCHAS CALIENTES**  
**CHIPS WARMERS / WARMING SURFACES**



**Base Aquecida**  
 Base chauffée  
 Base Caliente  
 Heated Base



MODELO / MODÈLE / MODELO / MODEL	PCI 4712
CÓDIGO / CODE / CÓDIGO / CODE	2 LAMP 3500.206
<b>Preço / Prix / Precio / Price</b>	<b>€ 1.024,00</b>
Dimensões / Dimensions / Dimensiones (LPA)	mm 850x 640x 800
Lâmpadas / Lampes / Lámparas / Lamps	nr 2
Temperatura / Temperature / Temperatura / Temperatura	°C 30 a 90
Peso Líquido-Bruto / Poids Net-Brut / Peso Neto-Bruto / Net-Gross Weight	kg 10-11
Potência / Puissance / Potencia / Power	kW 450+500
Tensão / Tension / Tensión / Tension	V 230



MODELO / MODÈLE / MODELO / MODEL	PCI 4713
CÓDIGO / CODE / CÓDIGO / CODE	3500.208
<b>Preço / Prix / Precio / Price</b>	<b>€ 1.312,00</b>
Dimensões / Dimensions / Dimensiones (LPA)	mm 1270x 680x 800
Lâmpadas / Lampes / Lámparas / Lamps	nr 3
Temperatura / Temperature / Temperatura / Temperatura	°C 30 a 90
Peso Líquido-Bruto / Poids Net-Brut / Peso Neto-Bruto / Net-Gross Weight	kg 11-13
Potência / Puissance / Potencia / Power	kW 600+700
Tensão / Tension / Tensión / Tension	V 230

**Aquecedor de batatas fritas**  
 Chauffe pommes frites  
 Calentador de patatas fritas  
 Chips warmers



MODELO / MODÈLE / MODELO / MODEL	SP170
CÓDIGO / CODE / CÓDIGO / CODE	2058.706
<b>Preço / Prix / Precio / Price</b>	<b>€ 1.974,00</b>
Dimensões / Dimensions / Dimensiones (LPA)	mm 400x 700x 810
Peso / Poids / Peso / Weight	kg 22
Potência / Puissance / Potencia / Power	kW 0,8
Tensão / Tension / Tensión / Tension	V 230

**Aquecedor de salsichas**  
 Chauffe saucisses  
 Calentador de salchichas  
 Hotdog heater



MODELO / MODÈLE / MODELO / MODEL	CS3G GAS
CÓDIGO / CODE / CÓDIGO / CODE	2230.024
<b>Preço / Prix / Precio / Price</b>	<b>€ 915,00</b>
Dimensões / Dimensions / Dimensiones (LPA)	mm 440x 300x 400
Capacidade / Capacité / Capacidad / Capacity	nr -
Temperatura / Temperature / Temperatura / Temperatura	°C -
Peso / Poids / Peso / Weight	kg 10
Potência / Puissance / Potencia / Power	kW 2
Tensão / Tension / Tensión / Tension	V -

**Aquecedor de salsichas**  
 Chauffe saucisses  
 Calentador de salchichas  
 Hotdog heater



MODELO / MODÈLE / MODELO / MODEL	GN 1
CÓDIGO / CODE / CÓDIGO / CODE	2125.692
<b>Preço / Prix / Precio / Price</b>	<b>€ 1.213,00</b>
Dimensões / Dimensions / Dimensiones (LPA)	mm 400x650x295/300
Capacidade / Capacité / Capacidad / Capacity	nr -
Potência / Puissance / Potencia / Power	kW 3,2
Tensão / Tension / Tensión / Tension	V 400

confirmar disponibilidade  
 confirmer la disponibilité  
 confirmar la disponibilidad  
 confirm the availability



UDA 60 / UDA 120  
 Construção geral aço inox;  
 Regulação da temperatura: 30° a 90°C  
 Prateleira ajustável



UDA 60 / UDA 120  
 Construction en acier inox;  
 Regulation de temperature 30-90°C;  
 Avec étagère réglable.



UDA 60 / UDA 120  
 Construcción en acero inoxidable;  
 Regulación de temperatura 30-90°C;  
 Con estante ajustable.



UDA 60 / UDA 120  
 General stainless steel construction;  
 Temperature regulation: 30° to 90°C;  
 Adjustable shelf;



**Aquecedor de tabuleiros por placa**  
 Réchauffeur de plateaux par planche  
 Calentador de bandejas por placa  
 Tray heater by plate



MODELO / MODÈLE / MODELO / MODEL CÓDIGO / CODE / CÓDIGO / CODE		DW 110 GRIL 2230.015
<b>Preço / Prix / Precio / Price</b>	<b>€</b>	<b>1.457,00</b>
Dimensões / Dimensions / Dimensiones (LPA)	mm	400x 215x 475
Capacidade / Capacité / Capacidad / Capacity	nr	10
Peso / Poids / Peso / Weight	kg	25
Potência / Puissance / Potencia / Power	kW	1,3
Tensão / Tension / Tensión / Tension	V	230



MODELO / MODÈLE / MODELO / MODEL CÓDIGO / CODE / CÓDIGO / CODE		SPT30 2083.093
<b>Preço / Prix / Precio / Price</b>	<b>€</b>	<b>861,00</b>
Dimensões / Dimensions / Dimensiones (LPA)	mm	400x420x550
Capacidade / Capacité / Capacidad / Capacity	nr	30
Peso / Poids / Peso / Weight	kg	22
Potência / Puissance / Potencia / Power	kW	0,4
Tensão / Tension / Tensión / Tension	V	230



MODELO / MODÈLE / MODELO / MODEL CÓDIGO / CODE / CÓDIGO / CODE		UDA 60 3010.126
<b>Preço / Prix / Precio / Price</b>	<b>€</b>	<b>584,00</b>
Dimensões / Dimensions / Dimensiones (LPA)	mm	400x 460x 870
Capacidade / Capacité / Capacidad / Capacity	nr	60
Diametro Pratos / Diametre assiettes / Diametro platos / Plates diameter	cm	30
Temperatura / Temperature / Temperatura / Temperatura	°C	30 a 90
Peso / Poids / Peso / Weight	kg	25,5
Potência / Puissance / Potencia / Power	kW	0,75
Tensão / Tension / Tensión / Tension	V	230



MODELO / MODÈLE / MODELO / MODEL CÓDIGO / CODE / CÓDIGO / CODE		UDA120 3010.128
<b>Preço / Prix / Precio / Price</b>	<b>€</b>	<b>991,00</b>
Dimensões / Dimensions / Dimensiones (LPA)	mm	800x 460x 870
Capacidade / Capacité / Capacidad / Capacity	nr	120
Diametro Pratos / Diametre assiettes / Diametro platos / Plates diameter	cm	30
Temperatura / Temperature / Temperatura / Temperatura	°C	30 a 90
Peso / Poids / Peso / Weight	kg	44
Potência / Puissance / Potencia / Power	kW	1,5
Tensão / Tension / Tensión / Tension	V	230



UDI

## AQUECEDOR DE PRATOS E TABULEIROS

CHAUFFE ASSIETTES ET PLATEAUX

CALENTADOR DE PLATOS Y BANDEJAS

PLATES AND TRAYS WARMERS



Aquecedor de pratos em aço inox  
Desenho ergonómico  
Rodas com travão



Réchauffeur de plaque d'acier inoxydable  
Design ergonomique  
Roues avec frein



Calentador de platos de acero inoxidable  
Diseño ergonómico  
Ruedas con freno



Stainless steel plate heater  
Ergonomic design  
Wheels with brake



MODELO / MODÈLE / MODELO / MODEL		UDAQPST53
CÓDIGO / CODE / CÓDIGO / CODE		5900.220
<b>Preço / Prix / Precio / Price</b>	<b>€</b>	<b>1.508,00</b>
Dimensões / Dimensions / Dimensiones (LPA)	mm	530x480x850
Dímetro Pratos / Diametre assiettes / Dímetro platos / Plates diameter	cm	22>32
Capacidade / Capacité / Capacidad / Capacity	nr	50
Peso / Poids / Peso / Weight	kg	42
Potência / Puissance / Potencia / Power	W	750
Tensão / Tension / Tensión / Tension	V	230



MODELO / MODÈLE / MODELO / MODEL		UDAQPDC53
CÓDIGO / CODE / CÓDIGO / CODE		5900.225
<b>Preço / Prix / Precio / Price</b>	<b>€</b>	<b>2.525,00</b>
Dimensões / Dimensions / Dimensiones (LPA)	mm	530x1000x850
Dímetro Pratos / Diametre assiettes / Dímetro platos / Plates diameter	cm	22>32
Capacidade / Capacité / Capacidad / Capacity	nr	100
Peso / Poids / Peso / Weight	kg	67
Potência / Puissance / Potencia / Power	W	750
Tensão / Tension / Tensión / Tension	V	230



Construção em aço inox. Placa em aço polido. Modelos elétricos com termostato de Controlo e indicadores luminosos.



Construction en acier inox. Plaque en acier poli. Modèles électriques avec thermostat de contrôle et viseurs lumineux.



Construcción en acero inoxidable. Placa de acero pulido. Modelos eléctricos con termostato de control y indicadores luminosos.



Stainless steel construction. Polished steel plate. Thermostat control and pilot lights.



Misto / Mixte / Mixto / Mixed

Nervurado / Strié / Acanalado / Ribbed



MODELO / MODÈLE / MODELO / MODEL	UPE 1 NERV.	
CÓDIGO / CODE / CÓDIGO / CODE	3010.084	
<b>Preço / Prix / Precio / Price</b>	€	<b>617,00</b>
Dimensões / Dimensions / Dimensiones	mm	400x460x285
Superfície Útil / Surf. Utile / Super. Útil / Work. Surface	mm	400x390
Peso Líquido / Poids Net / Peso Neto / Net Weight	kg	19,5
Potência / Puissance / Potencia / Power	W	3000
Tensão / Tension / Tensión / Tension	V	230



MODELO / MODÈLE / MODELO / MODEL	UPE 2 NERV.	
CÓDIGO / CODE / CÓDIGO / CODE	3010.086	
<b>Preço / Prix / Precio / Price</b>	€	<b>882,00</b>
Dimensões / Dimensions / Dimensiones	mm	600x460x285
Superfície Útil / Surf. Utile / Super. Útil / Work. Surface	mm	400x590
Peso Líquido / Poids Net / Peso Neto / Net Weight	kg	25
Potência / Puissance / Potencia / Power	W	4500
Tensão / Tension / Tensión / Tension	V	230



MODELO / MODÈLE / MODELO / MODEL	UPE 3 NERV.	
CÓDIGO / CODE / CÓDIGO / CODE	3010.088	
<b>Preço / Prix / Precio / Price</b>	€	<b>1.093,00</b>
Dimensões / Dimensions / Dimensiones	mm	800x460x285
Superfície Útil / Surf. Utile / Super. Útil / Work. Surface	mm	400x790
Peso Líquido / Poids Net / Peso Neto / Net Weight	kg	30
Potência / Puissance / Potencia / Power	W	6000
Tensão / Tension / Tensión / Tension	V	400



UDI

**PLACAS ELÉTRICAS - FRYTOPS**  
PLAQUES ET ELECTRIQUES - FRYTOPS  
PLANCHAS ELECTRICAS - FRYTOPS  
ELETRIC PLATES - FRYTOPS



Construção em aço inox. Placa em aço polido. Modelos elétricos com termostato de Controlo e indicadores luminosos.



Construction en acier inox. Plaque en acier poli. Modèles électriques avec thermostat de contrôle et viseurs lumineux.



Construcción en acero inoxidable. Placa de acero pulido. Modelos eléctricos con termostato de control y indicadores luminosos.



Stainless steel construction. Polished steel plate. Thermostat control and pilot lights.

Liso / Lisse / Liso / Flat



MODELO / MODÈLE / MODELO / MODEL	UPE 1	
CÓDIGO / CODE / CÓDIGO / CODE	3010.082	
<b>Preço / Prix / Precio / Price</b>	€	<b>427,00</b>
Dimensões / Dimensions / Dimensiones	mm	400x460x250
Superfície Útil / Surf. Utile / Super. Útil / Work. Surface	mm	380x370
Peso Líquido / Poids Net / Peso Neto / Net Weight	kg	14,5
Potência / Puissance / Potencia / Power	W	2500
Tensão / Tension / Tensión / Tension	V	230



MODELO / MODÈLE / MODELO / MODEL	UPE 2	
CÓDIGO / CODE / CÓDIGO / CODE	3010.080	
<b>Preço / Prix / Precio / Price</b>	€	<b>623,00</b>
Dimensões / Dimensions / Dimensiones	mm	600x460x250
Superfície Útil / Surf. Utile / Super. Útil / Work. Surface	mm	580x370
Peso Líquido / Poids Net / Peso Neto / Net Weight	kg	20
Potência / Puissance / Potencia / Power	W	3500
Tensão / Tension / Tensión / Tension	V	230



**Modelo Snack**  
3 Zonas  
Revestimento cerâmico

MODELO / MODÈLE / MODELO / MODEL	UPE 3	
CÓDIGO / CODE / CÓDIGO / CODE	3010.078	
<b>Preço / Prix / Precio / Price</b>	€	<b>734,00</b>
Dimensões / Dimensions / Dimensiones	mm	800x460x250
Superfície Útil / Surf. Utile / Super. Útil / Work. Surface	mm	780x370
Peso Líquido / Poids Net / Peso Neto / Net Weight	kg	25
Potência / Puissance / Potencia / Power	W	4500
Tensão / Tension / Tensión / Tension	V	400





Os grelhadores e chapas são equipados com alto nível de qualidade, potência, acabamentos, solidez, simplicidade de utilização e manutenção.



Les grils et contacts grils sont équipés d'un haut niveau de qualité, puissance, de finition, solidité, simplicité d'utilisation et maintenance.



Los grills y placas están equipados con alto nivel de calidad, potencia, terminaciones, robustez, simpleza de utilización y mantenimiento.



The grills and contact-Grills are equipped with a high level of quality, power, top-finishings, hard-wearing, they are simple to use and maintain.

Nervurado / Strié / Acanalado / Ribbed

Liso / Lisse / Liso / Flat



MODELO / MODÈLE / MODELO / MODEL		XAR/2	XAL/2
CÓDIGO / CODE / CÓDIGO / CODE		2800.542	2800.540
<b>Preço / Prix / Precio / Price</b>	<b>€</b>	<b>1.029,00</b>	<b>1.029,00</b>
Dimensões / Dimensions / Dimensiones	mm	420x360x200	420x360x200
Superfície Útil / Surf. Utile / Super. Útil / Work. Surface	mm	340x230	340x230
Nervurada / Rainurée / Nervurada / Grooved		√	√
Lisa / Lisse / Plana / Smooth		-	√
Peso Líquido / Poids Net / Peso Neto / Net Weight	kg	15	14
Potência / Puissance / Potencia / Power	kW	2,2	2,2
Tensão / Tension / Tensión / Tension	V	230	230



#pés/feet - H100mm

MODELO / MODÈLE / MODELO / MODEL		PANINI XL
CÓDIGO / CODE / CÓDIGO / CODE		2230.320
<b>Preço / Prix / Precio / Price</b>	<b>€</b>	<b>1.258,00</b>
Dimensões / Dimensions / Dimensiones	mm	410x620x340
Superfície Útil / Surf. Utile / Super. Útil / Work. Surface	mm	360x360
Nervurada / Rainurée / Nervurada / Grooved		√
Lisa / Lisse / Plana / Smooth		-
Peso Líquido / Poids Net / Peso Neto / Net Weight	kg	32
Potência / Puissance / Potencia / Power	kW	3,6
Tensão / Tension / Tensión / Tension	V	230



Timer electronic - 3 menus

MODELO / MODÈLE / MODELO / MODEL		PANINI XLE
CÓDIGO / CODE / CÓDIGO / CODE		2230.322
<b>Preço / Prix / Precio / Price</b>	<b>€</b>	<b>1.467,00</b>
Dimensões / Dimensions / Dimensiones	mm	410x620x340
Superfície Útil / Surf. Utile / Super. Útil / Work. Surface	mm	360x360
Nervurada / Rainurée / Nervurada / Grooved		√
Lisa / Lisse / Plana / Smooth		-
Peso Líquido / Poids Net / Peso Neto / Net Weight	kg	34
Potência / Puissance / Potencia / Power	kW	3,6
Tensão / Tension / Tensión / Tension	V	230



2800.546

MODELO / MODÈLE / MODELO / MODEL		XBR/2	XBL/2	XBM/2
CÓDIGO / CODE / CÓDIGO / CODE		2800.546	2800.544	2800.548
<b>Preço / Prix / Precio / Price</b>	<b>€</b>	<b>1.418,00</b>	<b>1.418,00</b>	<b>1.418,00</b>
Dimensões / Dimensions / Dimensiones	mm	570x360x200	570x360x200	570x360x200
Superfície Útil / Surf. Utile / Super. Útil / Work. Surface	mm	480x230	480x230	480x230
Nervurada / Rainurée / Nervurada / Grooved		√	-	-
Lisa / Lisse / Plana / Smooth		-	√	-
Mistos / Mixte / Mixtos / Mixed		-	-	√
Peso Líquido / Poids Net / Peso Neto / Net Weight	kg	14	14	14
Potência / Puissance / Potencia / Power	kW	3,6	3,6	3,6
Tensão / Tension / Tensión / Tension	V	400	400	400



UDI

## GRELHADORES DE CONTACTO

GRILS ET CONTACTS GRILS

PARRILLAS DE CONTACTO

CONTACT GRILLS



Forte capacidade de aquecimento pela repartição regular do calor em espiral em toda a superfície da placa. Limpeza rápida e higiénica.



Forte capacité de chauffage par la répartition de la chaleur en spiral sur toute la superficie. Nettoyage rapide et hygiénique.



Gran capacidad de calentamiento debido a la distribución regular de calor en espiral sobre toda la superficie. Limpieza rápida e higiénica.



Strong heating capacity through the spiral-heat distribution all over the surface. Quick and hygienic cleaning.



Nervurado / Strié / Acanalado / Ribbed

Liso / Lisse / Liso / Flat



MODELO / MODELE / MODELO / MODEL	UGP27X35
CÓDIGO / CODE / CÓDIGO / CODE	2522.889
<b>Preço / Prix / Precio / Price</b>	<b>€ 561,00</b>
Dimensões / Dimensions / Dimensiones	mm 410x430x280
Superfície útil / Surf. Utile / Super. Útil / Work. Surface	mm 270x350
Peso Líquido-Bruto / Poids Net-Brut / Peso Neto-Bruto / Net-Gross Weight	kg 25-30
Potência / Puissance / Potência / Power	kW 2,5
Tensão / Tension / Tensión / Tension	V 230



MODELO / MODELE / MODELO / MODEL	UGPD55X30
CÓDIGO / CODE / CÓDIGO / CODE	2522.896
<b>Preço / Prix / Precio / Price</b>	<b>€ 900,00</b>
Dimensões / Dimensions / Dimensiones	mm 560x370x260
Superfície útil / Surf. Utile / Super. Útil / Work. Surface	mm 550x300
Peso Líquido-Bruto / Poids Net-Brut / Peso Neto-Bruto / Net-Gross Weight	kg 32-33
Potência / Puissance / Potência / Power	kW 2+2
Tensão / Tension / Tensión / Tension	V 230



MODELO / MODELE / MODELO / MODEL	UGP 60X40
CÓDIGO / CODE / CÓDIGO / CODE	2522.898
<b>Preço / Prix / Precio / Price</b>	<b>€ 1.102,00</b>
Dimensões / Dimensions / Dimensiones	mm 640x480x280
Superfície útil / Surf. Utile / Super. Útil / Work. Surface	mm 600x400
Peso Líquido-Bruto / Poids Net-Brut / Peso Neto-Bruto / Net-Gross Weight	kg 65-67
Potência / Puissance / Potência / Power	kW 6
Tensão / Tension / Tensión / Tension	V 230



Totalmente construído em aço inoxidável AISI 304. O motor está protegido do calor pois está fixado na parte inferior do gyro. O corpo principal do gyro com os queimadores move-se para a frente e para trás. Possibilidade de regular a distância entre o espeto e os queimadores/resistências. Tabuleiro de gordura removível pela parte inferior. Linhas redondas para uma limpeza fácil.



Complètement construit en acier inox AISI 304. Le moteur est protégé de la chaleur car elle est fixée à la partie inférieure du gyro. Le corps principal de le gyro avec brûleurs se déplace vers l'avant et vers l'arrière. Possibilité de régler la distance entre les brûleurs et les brochettes/résistances. Collecteur d'huile amovible pour le fond. Lignes arrondies pour un nettoyage facile.



Construído totalmente en acero inoxidable AISI 304. El motor está protegido del calor, ya que está fijado en la parte inferior del asador. El cuerpo principal de lo asador con los quemadores se mueve hacia adelante y hacia atrás. Posibilidad de ajustar la distancia entre los quemadores/resistencias. Bandeja de aceite removible por la parte inferior. Líneas redondas para facilitar la limpieza.



Completely realized in stainless steel AISI 304. Motor placed at the bottom protected from the heat. The main body of the gyro with the burners moves forward and backward. Possibility of adjusting the distance between the spit and the burners/heating elements. Removable oil container at the bottom. Rounded lines for easy cleaning.



MODELO / MODÈLE / MODELO / MODEL CÓDIGO / CODE / CÓDIGO / CODE		GAS GRG 60 2230.051	GAS GRG 80 2230.052
<b>Preço / Prix / Precio / Price</b>	€	<b>2.342,00</b>	<b>2.529,00</b>
Dimensões / Dimensions / Dimensiones	mm	510x610x895	510x610x1080
Peso Líquido / Poids Net / Peso Neto / Net Weight	kg	23	27
Potência / Puissance / Potencia / Power	kW	10,5	14
Tensão / Tension / Tensión / Tension	V	-	-



MODELO / MODÈLE / MODELO / MODEL CÓDIGO / CODE / CÓDIGO / CODE		DE 1A 2058.710
<b>Preço / Prix / Precio / Price</b>	€	<b>1.762,00</b>
Dimensões / Dimensions / Dimensiones	mm	530x640x670
Peso Líquido / Poids Net / Peso Neto / Net Weight	kg	20
Potência / Puissance / Potencia / Power	kW	4,9
Tensão / Tension / Tensión / Tension	v	400



MODELO / MODÈLE / MODELO / MODEL CÓDIGO / CODE / CÓDIGO / CODE		DE 3A 2058.714
<b>Preço / Prix / Precio / Price</b>	€	<b>2.418,00</b>
Dimensões / Dimensions / Dimensiones	mm	530x640x990
Peso Líquido / Poids Net / Peso Neto / Net Weight	kg	40
Potência / Puissance / Potencia / Power	kW	9,9
Tensão / Tension / Tensión / Tension	v	400



MODELO / MODÈLE / MODELO / MODEL CÓDIGO / CODE / CÓDIGO / CODE		DG 6A 2058.722
<b>Preço / Prix / Precio / Price</b>	€	<b>2.519,00</b>
Dimensões / Dimensions / Dimensiones	mm	530x640x830
Peso Líquido / Poids Net / Peso Neto / Net Weight	kg	30
Consumo G20 (Gás Natural) / Cons. G20 (gaz naturel) / Cons. G20 (Gas Natural) Cons. G20 (Natural Gas)	m3/h	1
Consumo G30/31 / Cons. G30/31 / Cons. G30/31 / Cons. G30/31	Kg/h	0,40
Potência / Puissance / Potencia / Power	kW	10,5
Tensão / Tension / Tensión / Tension	v	230





UDI



confirmar disponibilidade  
confirmer la disponibilité  
confirm the availability

**GYROS GRILL ELÉTRICOS OU GÁS**  
GYROS GRIL ÉLECTRIQUES OU GAS  
ASADORES GYROS ELÉTRICOS O AL GAS  
ELECTRIC OR GAS GYROS GRILL



Totalmente construído em aço inoxidável AISI 304. O motor está protegido do calor pois está fixado na parte inferior do gyro. O corpo principal do gyro com os queimadores move-se para a frente e para trás. Possibilidade de regular a distância entre o espeto e os queimadores/resistências. redondas para uma limpeza fácil.



Complètement construit en acier inox AISI 304. Le moteur est protégé de la chaleur car elle est fixée à la partie inférieure du gyro. Le corps principal de le gyro avec brûleurs se déplace vers l'avant et vers l'arrière. Possibilité de régler la distance entre les brûleurs et les brochettes/résistances. Collecteur d'huile amovible pour le fond. Lignes arrondies pour un nettoyage facile.



Construido totalmente en acero inoxidable AISI 304. El motor está protegido del calor, ya que está fijado en la parte inferior del asador. El cuerpo principal de lo asador con los quemadores se mueve hacia adelante y hacia atrás. Posibilidad de ajustar la distancia entre los quemadores/resistencias. Bandeja de aceite removible por la parte inferior. Líneas redondas para facilitar la limpieza.



Completely realized in stainless steel AISI 304. Motor placed at the bottom protected from the heat. The main body of the gyro with the burners moves forward and backward. Possibility of adjusting the distance between the spit and the burners/heating elements. Removable oil container at the bottom. Rounded lines for easy cleaning.



Regul. Máx. Min.

Comutadores  
Interrupteurs  
Conmutadores  
Switches

3 4 5

UDIGY170 UDIGY171 UDIGY172  
5200.096 5200.098 5200.099

MODELO / MODÈLE / MODELO / MODEL CÓDIGO / CODE / CÓDIGO / CODE	UDIGY170 5200.096	UDIGY171 5200.098	UDIGY172 5200.099
<b>Preço / Prix / Precio / Price</b>	<b>€ 2.265,00</b>	<b>€ 2.571,00</b>	<b>€ 2.854,00</b>
Dimensões / Dimensions / Dimensiones	mm 710x667x978	741x632x1143	738x667x1305
Peso Líquido-Bruto / Poids Net-Brut / Peso Neto-Bruto / Net-Gross Weight	kg 30-36	40-41	45-53
Potência / Puissance / Potencia / Power	kW 4,2	5,6	7
Tensão / Tension / Tensión / Tension	V 400	400	400



Regul. Máx. Min.

Queimadores  
Bruleurs  
Queimadores  
Burners

3 4 5

UDIGY150 UDIGY151 UDIGY152  
5200.090 5200.092 5200.094

MODELO / MODÈLE / MODELO / MODEL CÓDIGO / CODE / CÓDIGO / CODE	UDIGY150 5200.090	UDIGY151 5200.092
<b>Preço / Prix / Precio / Price</b>	<b>€ 1.699,00</b>	<b>€ 1.856,00</b>
Dimensões / Dimensions / Dimensiones	mm 737x619x978	748x619x1047
Peso Líquido-Bruto / Poids Net-Brut / Peso Neto-Bruto / Net-Gross Weight	kg 30-36	45-46
Potência / Puissance / Potencia / Power	kW 10,5	14
Tensão / Tension / Tensión / Tension	V 230	230



elétrico  
électrique  
eléctrico  
electric



gás  
gaz  
gas  
gas

De fácil utilização, estes Micro-Ondas são os aparelhos ideais para um rápido aquecimento dos seus alimentos. Equipado com um temporizador manual ou eletrónico, obterá um serviço mais conveniente.

Facile à utiliser, ces Microondes sont les appareils idéales pour un chauffage rapide des aliments. Équipé avec une minuterie de manuelle ou électronique, obtiendra un service plus commode.

Fáciles de usar, estos Microondas son los aparatos ideales para calentar rápidamente sus alimentos. Equipado con un temporizador manual o electrónico, obtendrá un servicio más conveniente.

Easy to use, these Microwaves are the ideal devices for fast heating of food. Equipped with a manual or electronic timer you will get a more convenient service.

UDIMICRO20



Grill +  
Microondas

UDMICRO27SS



Grill +  
Microondas +  
Forno Convotor

UDIMICRO25



MODELO / MODÈLE / MODELO / MODEL CÓDIGO / CODE / CÓDIGO / CODE		UDIMICRO20 2829.670	UDMICRO27SS 2829.675	UDIMICRO25 2829.677
<b>Preço / Prix / Precio / Price</b>	€	<b>146,00</b>	<b>230,00</b>	<b>312,00</b>
Dimensões / Dimensions / Dimensiones	mm	440x341x300	485x393x293	510x470x305
Descongelação / Décongélation / Descongelación / Defrost		-	-	-
Capacidade / Capacidad / Capacité / Capacidad / Capacity	lt	20	23	25
Cor Interior / Couleur Intérieure / Color Interior / Interior Color		branco	cinza escuro	cinza escuro
Cor Exterior / Couleur Extérieure / Color Exterior / Exterior Color		branco	aço inox	branco
Temporizador / Minuterie / Temporizador / Timer		√	√	√
Eletrónico / Électronique / Electrónico / Electronic		-	√	√
Prato Vidro / Plaque de Verre / Placa de Vidrio / Glass Tray		√	√	√
Diametro Prato / Diamètre de plat / diámetro plato / Dish diameter	mm	255	270	270
Grill / Grill / Grill / Grill		-	√	√
Peso Líquido-Bruto / Poids Net-Brut / Peso Neto-Bruto / Net-Gross Weight	kg	10,2	13-14,5	18-20,5
Potência Grill / Puissance Grill / Potencia Grill / Grill Power	kW	-	1	1,1
Potência / Puissance / Potencia / Power	kW	0,7	0,8	0,9
Tensão / Tension / Tensión / Tension	V	230	230	230



Grill +  
Microondas +  
Forno Convotor

MODELO / MODÈLE / MODELO / MODEL CÓDIGO / CODE / CÓDIGO / CODE		UMG38 2107.604
<b>Preço / Prix / Precio / Price</b>	€	<b>941,00</b>
Dimensões / Dimensions / Dimensiones	mm	595x542x460
Descongelação / Décongélation / Descongelación / Defrost		√
Capacidade / Capacidad / Capacité / Capacidad / Capacity	lt	38
Cor Interior / Couleur Intérieure / Color Interior / Interior Color		aço inox
Cor Exterior / Couleur Extérieure / Color Exterior / Exterior Color		aço inox
Temporizador / Minuterie / Temporizador / Timer		√
Eletrónico / Électronique / Electrónico / Electronic		√
Prato Vidro / Plaque de Verre / Placa de Vidrio / Glass Tray		√
Diametro Prato / Diamètre de plat / diámetro plato / Dish diameter	mm	320
Grill / Grill / Grill / Grill		√
Peso Líquido / Poids Net / Peso Neto / Net Weight	kg	32
Potência Grill / Puissance Grill / Potencia Grill / Grill Power	kW	1,5
Potência / Puissance / Potencia / Power	kW	3,4
Tensão / Tension / Tensión / Tension	V	230





UDI

PLACAS DE INDUÇÃO  
PLAQUES À INDUCTION  
PLACAS DE INDUCCIÓN  
INDUCTION PLATES



**PDF**  
Placa de cozedura rápida, sem chama, com um sistema de indução de calor a partir da placa para o recipiente. A máquina irá parar quando o recipiente (adequado apenas para indução) for removido. Modos de funcionamento: Com níveis de potência ou temperatura (°C). Placa: Ø 140/220mm.

**BT**  
Máquina com sistema de cozedura por indução de calor do prato ao recipiente (tipo metal) para panela WOK (a encomendar à parte). Estrutura em aço inox - placa vitrocerâmica - funcionamento em modo potência ou temperatura - temporizador digital.



**PDF**  
Machine pour cuire en peu temps, sans flammé, par système à induction de chaleur de la plaque au récipient. Après retrait du récipient (qui doit absolument être pour induction) la machine s'arrête. Mode de fonctionnement: niveaux de puissance ou température (°C). Plaque: Ø 140/220mm.

**BT**  
Machine avec système de cuisson par induction de chaleur de la plaque au récipient de la poêle à wok (à commander séparément). Structure en acier inoxydable - plaque vitrocéramique - fonctionnement en mode puissance ou température - minuterie numérique.



**PDF**  
Máquina para cocinar en un tiempo breve, sin llama, con sistema por inducción magnética del calor desde la placa al contenedor. La máquina se detiene si quitar el contenedor (adecuado sólo para inducción). Modos de operación: Con niveles de potencia o temperatura (°C). Plaque: Ø 140/220mm.

**BT**  
Máquina con sistema de cocción por inducción térmica desde el plato hasta el recipiente de la sartén wok (a pedir aparte). Estructura de acero inoxidable - placa vitrocerámica - funcionamiento en modo de potencia o temperatura - temporizador digital.



**PDF**  
Quick cooking appliance, flameless, with a heat induction system from the plate to the container. The machine stops when the container (metallic only) is removed. Operating modes: power level or temperature (°C). Plate: Ø 140/220mm.

**BT**  
Machine with heat induction cooking system from the plate to the wok pan container (to be ordered apart). Stainless steel structure - glass ceramic plate - operation in power or temperature mode - digital timer.



NOVO  
NOUVEAU  
NUEVO  
NEW

MODELO / MODÈLE / MODELO / MODEL		BT350W
CÓDIGO / CODE / CÓDIGO / CODE		2088.724
Preço / Prix / Precio / Price	€	404,00
Dimensões / Dimensions / Dimensiones	mm	343x440x120
Peso Líquido-Bruto / Poids Net-Brut / Peso Neto-Bruto / Net-Gross Weight	kg	8-11
Potência / Puissance / Potencia / Power	kW	3,5
Tensão / Tension / Tensión / Tension	V	230



NOVO  
NOUVEAU  
NUEVO  
NEW

MODELO / MODÈLE / MODELO / MODEL		WOK / P INDUÇÃO
CÓDIGO / CODE / CÓDIGO / CODE		2088.726
Preço / Prix / Precio / Price	€	158,00
Dimensões / Dimensions / Dimensiones	Ø mm	360
Peso Líquido-Bruto / Poids Net-Brut / Peso Neto-Bruto / Net-Gross Weight	kg	2,9-3,5



MODELO / MODÈLE / MODELO / MODEL		PFD 27
CÓDIGO / CODE / CÓDIGO / CODE		2088.720
Preço / Prix / Precio / Price	€	283,00
Dimensões / Dimensions / Dimensiones	mm	325x370x105
Peso Líquido / Poids Net / Peso Neto / Net Weight	kg	5
Potência / Puissance / Potencia / Power	kW	2,7
Tensão / Tension / Tensión / Tension	V	230



MODELO / MODÈLE / MODELO / MODEL		PFD 35
CÓDIGO / CODE / CÓDIGO / CODE		2088.722
Preço / Prix / Precio / Price	€	399,00
Dimensões / Dimensions / Dimensiones	mm	343x440x120
Peso Líquido / Poids Net / Peso Neto / Net Weight	kg	8
Potência / Puissance / Potencia / Power	kW	3,5
Tensão / Tension / Tensión / Tension	V	230



GPL ou gás natural.  
 Válvula de segurança com piloto.  
 Duas zonas de aquecimento separadas.  
 Sistema de ignição piezoelétrica para cada módulo.  
 Placa de ferro fundido.  
 Fácil de limpar e higiénico.  
 Corpo de aço inoxidável.



GPL ou gaz naturel.  
 Soupape de sécurité avec pilote.  
 Deux zones de chauffage séparées.  
 Système d'allumage piézoélectrique pour chaque module.  
 Plaque en fonte.  
 Facile à nettoyer et hygiénique.  
 Corps en acier inoxydable.



GPL o gas natural.  
 Válvula de seguridad con piloto.  
 Dos zonas de calefacción separadas.  
 Sistema de encendido piezoeléctrico para cada módulo.  
 Placa de hierro fundido.  
 Fácil de limpiar e higiénico.  
 Cuerpo de acero inoxidable.



LPG or natural gas.  
 Safety valve with pilot.  
 Two separate heating zones.  
 Piezoelectric ignition system for each module.  
 Cast iron plate.  
 Easy to clean and hygienic.  
 Stainless steel body.



MODELO / MODÈLE / MODELO / MODEL	UDGA010
CÓDIGO / CODE / CÓDIGO / CODE	5200.087
<b>Preço / Prix / Precio / Price</b>	€ <b>1.528,00</b>
Dimensões / Dimensions / Dimensiones	mm 400x730x285
Peso Líquido-Bruto / Poids Net-Brut / Peso Neto-Bruto / Net-Gross Weight	kg 45-48
Potência / Puissance / Potencia / Power	Qn/kW 5,2



MODELO / MODÈLE / MODELO / MODEL	UDGA020
CÓDIGO / CODE / CÓDIGO / CODE	5200.088
<b>Preço / Prix / Precio / Price</b>	€ <b>2.465,00</b>
Dimensões / Dimensions / Dimensiones	mm 800x730x285
Peso Líquido-Bruto / Poids Net-Brut / Peso Neto-Bruto / Net-Gross Weight	kg 96-108
Potência / Puissance / Potencia / Power	Qn/kW 10,4



MODELO / MODÈLE / MODELO / MODEL	UDGA030
CÓDIGO / CODE / CÓDIGO / CODE	5200.089
<b>Preço / Prix / Precio / Price</b>	€ <b>3.511,00</b>
Dimensões / Dimensions / Dimensiones	mm 1200x730x285
Peso Líquido-Bruto / Poids Net-Brut / Peso Neto-Bruto / Net-Gross Weight	kg 135-137
Potência / Puissance / Potencia / Power	Qn/kW 15,6

Móveis em aço inox para grelhadores a água  
 Meubles en acier inoxydable pour les grils d'eau  
 Muebles de acero inoxidable para parrillas de agua  
 Stainless steel furniture for water grills



MODELO / MODÈLE / MODELO / MODEL	UDGA020
CÓDIGO / CODE / CÓDIGO / CODE	5200.262
<b>Preço / Prix / Precio / Price</b>	€ <b>635,00</b>
Dimensões / Dimensions / Dimensiones	mm 600x570x565
Peso Bruto / Poids Brut / Peso Bruto / Gross Weight	kg 30



UDI

TREMPES  
RÉCHAUDS  
COCINILLAS  
STOVES



Estrutura em aço inoxidável 304  
Durável  
Desenho ergonómico  
Fácil de limpar e higiénico



Cadre principal en acier inoxydable 304  
Robuste  
Design ergonomique  
Facile à nettoyer et hygiénique



Estructura de acero inoxidable 304  
Resistente  
Diseño ergonómico  
Fácil de limpiar e higiénico



Stainless steel 304 main frame  
Heavy duty  
Ergonomic design  
Easy to clean and hygienic



Grelha | Grid  
600x600mm

MODELO / MODÈLE / MODELO / MODEL CÓDIGO / CODE / CÓDIGO / CODE	MONOLITICO GÁS 5700.710	
<b>Preço / Prix / Precio / Price</b>	€	<b>911,00</b>
Dimensões / Dimensions / Dimensiones	mm	600x800x500
Peso / Poids / Peso / Weight	kg	58
Potência Queimadores / Puissance Brûleurs / Potencia Fuegos / Burners Power	kW	24
Diâmetro Queimadores / Diamètre Brûleurs / Diámetro Fuegos / Burners Diameter	mm	145 270



MODELO / MODÈLE / MODELO / MODEL CÓDIGO / CODE / CÓDIGO / CODE	MONOLITICO GÁS 5700.708	
<b>Preço / Prix / Precio / Price</b>	€	<b>680,00</b>
Dimensões / Dimensions / Dimensiones	mm	400x500x500
Peso / Poids / Peso / Weight	kg	35
Potência Queimadores / Puissance Brûleurs / Potencia Fuegos / Burners Power	kW	12
Diâmetro Queimador / Diamètre Brûleur / Diámetro Fuego / Burner Diameter	mm	180



MODELO / MODÈLE / MODELO / MODEL CÓDIGO / CODE / CÓDIGO / CODE	MONOLITICO ELÉTRICO 400V 5700.702	
<b>Preço / Prix / Precio / Price</b>	€	<b>1.135,00</b>
Dimensões / Dimensions / Dimensiones	mm	550x550x500
Peso / Poids / Peso / Weight	kg	35
Potência placas elétricas / Puissance plaques de cuisson / Potencia Placas Eléctricas / Hotplates Power	kW	4
Dimensões Queimadores / Dimensions Brûleurs / Dimensiones Fuegos / Burners Dimensions	mm	400x400



MODELO / MODÈLE / MODELO / MODEL CÓDIGO / CODE / CÓDIGO / CODE	MONOLITICO GÁS 5700.714	MONOLITICO GÁS 5700.716
<b>Preço / Prix / Precio / Price</b>	€ <b>1.115,00</b>	<b>1.372,00</b>
Dimensões / Dimensions / Dimensiones	mm 850x700x500	850x700x500
Peso / Poids / Peso / Weight	kg 70-75	70-75
Potência Queimadores / Puissance Brûleurs / Potencia Fuegos / Burners Power	kW 28	32
Diâmetro Queimadores / Diamètre Brûleurs / Diámetro Fuegos / Burners Diameter	mm 140 230 340	80 160 250 330



MODELO / MODÈLE / MODELO / MODEL	CFF1TPS TREMPE GAS BANC.1QUEIM	
CÓDIGO / CODE / CÓDIGO / CODE	2128.178	
<b>Preço / Prix / Precio / Price</b>	€	<b>747,00</b>
Dimensões / Dimensions / Dimensiones	mm	400x582x265
Potência Queimadores / Puissance Brûleurs / Potencia Fuegos / Burners Power	kW	1x5,5



MODELO / MODÈLE / MODELO / MODEL	CFF1TPA TREMPE GAS BANC.1QUEIM	
CÓDIGO / CODE / CÓDIGO / CODE	2128.180	
<b>Preço / Prix / Precio / Price</b>	€	<b>726,00</b>
Dimensões / Dimensions / Dimensiones	mm	400x582x265
Potência Queimadores / Puissance Brûleurs / Potencia Fuegos / Burners Power	kW	1x5,5



MODELO / MODÈLE / MODELO / MODEL	CFF1GPS TREMPE GAS MOV.1Q	
CÓDIGO / CODE / CÓDIGO / CODE	2128.190	
<b>Preço / Prix / Precio / Price</b>	€	<b>1.038,00</b>
Dimensões / Dimensions / Dimensiones	mm	400x585x500
Potência Queimadores / Puissance Brûleurs / Potencia Fuegos / Burners Power	kW	1x7



MODELO / MODÈLE / MODELO / MODEL	CFV00201 TREMPE GAS DUPLA	
CÓDIGO / CODE / CÓDIGO / CODE	2125.987	
<b>Preço / Prix / Precio / Price</b>	€	<b>1.040,00</b>
Dimensões / Dimensions / Dimensiones	mm	700x582x625
Potência Queimadores / Puissance Brûleurs / Potencia Fuegos / Burners Power	kW	1x3,5 + 1x5,5



MODELO / MODÈLE / MODELO / MODEL	CFFTPA TREMPE GAS BANC.3 QUEIM.	
CÓDIGO / CODE / CÓDIGO / CODE	2128.188	
<b>Preço / Prix / Precio / Price</b>	€	<b>1.337,00</b>
Dimensões / Dimensions / Dimensiones	mm	1050x582x265
Potência Queimadores / Puissance Brûleurs / Potencia Fuegos / Burners Power	kW	2x5,5 + 1x3,5



UDI



confirmar disponibilidade  
confirmar la disponibilité  
confirmar la disponibilidad  
confirm the availability

TREMPES  
RÉCHAUDS  
COCINILLAS  
STOVES



MODELO / MODÈLE / MODELO / MODEL	ELR 3 ELET.
CÓDIGO / CODE / CÓDIGO / CODE	2230.422
<b>Preço / Prix / Precio / Price</b>	<b>€ 668,00</b>
Dimensões / Dimensions / Dimensiones	mm 650x400x155
Peso / Poids / Peso / Weight	kg 9
Potência / Puissance / Potencia / Power	kW 1,5x2 (3)
Tensão / Tension / Tensión / Tension	V 230



MODELO / MODÈLE / MODELO / MODEL	GAR 7
CÓDIGO / CODE / CÓDIGO / CODE	2230.426
<b>Preço / Prix / Precio / Price</b>	<b>€ 756,00</b>
Dimensões / Dimensions / Dimensiones	mm 370x510x195
Peso / Poids / Peso / Weight	kg 12
Potência / Puissance / Potencia / Power	kW 7



MODELO / MODÈLE / MODELO / MODEL	GAR 14 (7+7)
CÓDIGO / CODE / CÓDIGO / CODE	2230.434
<b>Preço / Prix / Precio / Price</b>	<b>€ 1.168,00</b>
Dimensões / Dimensions / Dimensiones	mm 690x510x195
Peso / Poids / Peso / Weight	kg 12
Potência / Puissance / Potencia / Power	kW 14 (7+7)



MODELO / MODÈLE / MODELO / MODEL	GAR 19	GAR 21
CÓDIGO / CODE / CÓDIGO / CODE	2230.430	2230.432
<b>Preço / Prix / Precio / Price</b>	<b>€ 1.541,00</b>	<b>1.562,00</b>
Dimensões / Dimensions / Dimensiones	mm 1005x510x195	1005x510x195
Peso / Poids / Peso / Weight	kg 32	32
Potência / Puissance / Potencia / Power	kW 19	21



elétrico  
électrique  
eléctrico  
electric



gás  
gaz  
gas  
gas

Fabricado em aço inox com sistema de segurança, grelhas em ferro, pés reguláveis, tabuleiro inox de recolha de resíduos, está preparado para GPL e GN (Kit de conversão incluído). Modelos G: Totalmente construídos em aço inoxidável AISI304. A água aquecida pelos queimadores é evaporizada e este vapor permite que a carne permaneça tenra e não seque. Queimador de alta potência para cozedura rápida. Possibilidade de regular a chama para o nível desejado. Com válvula e termopar de segurança, isqueiro de ignição automática do queimador piloto.

Fabriqué en acier inoxydable avec système de sécurité, grilles de fer, pieds réglables, plateau de collecte des déchets en acier inoxydable, est préparé pour le GPL et GN (kit de conversion inclus). Modèles G: Totalment réalisés en acier inoxydable AISI 304. L'eau est chauffée par des brûleurs, est évaporée et cette vapeur aide à la viande de rester tendre sans séchage. Brûleur à haute puissance pour une cuisson rapide. Possibilité d'ajuster la flamme à la valeur désirée. Avec soupape et thermocouple de sécurité, plus léger, léger allumage automatique du brûleur pilote.

Fabricado en acero inoxidable con sistema de seguridad, parrillas de hierro, pies ajustables, bandeja de recogida de residuos en acero inoxidable, está pronto para GN y GLP (kit de conversión incluido). Modelos G: Construidos totalmente en acero inoxidable AISI 304. El agua calentada por quemadores es evaporada y este vapor permite que la carne quede tierna y no seque. Quemador de alta potencia para una cocción rápida. Posibilidad de ajustar la llama para el nivel deseado. Con válvula termopar de seguridad, encendedor automático de ignición del quemador piloto.

Made of stainless steel with security system, iron grids, adjustable feet, steel tray of waste collection, prepared to NG and LPG (conversion kit included). G models: Entirely made by stainless steel AISI304. The water heated by the burners, is evaporized and this steam helps the meat to remain tender without drying. High power burner - For fast cooking. Possibility to regulate the flame to the level you want. Controlled by valve with safety device (thermocouple), piezoelectric automatic ignition of pilot burner.



confirmar disponibilidade  
confirmer la disponibilité  
confirmar la disponibilidad  
confirm the availability

Profundidade / Profondeur Profundidad / Depth 600			
MODELO / MODÈLE / MODELO / MODEL		G 360WG	
CÓDIGO / CODE / CÓDIGO / CODE		2058.680	
<b>Preço / Prix / Precio / Price</b>	€	<b>3.066,00</b>	
Dimensões / Dimensions / Dimensiones	mm	1090x600x350	
Grelhas / Grilles / Rejillas / Grids	nr	3	
Consumo de Gás G20 / Cons. Gaz / Cons. Gas / Gas Cons.	m3/h	2,12	
Consumo de Gás G30-G31 / Cons. Gaz/ Cons. Gas / Gas Gons.	kg/h	0,84	
Peso Líquido / Poids Net / Peso Neto / Net Weight	kg	48	
Potência / Puissance / Potencia / Power	Qn/kW	22,2	



confirmar disponibilidade  
confirmer la disponibilité  
confirmar la disponibilidad  
confirm the availability

Profundidade / Profondeur Profundidad / Depth 700					
MODELO / MODÈLE / MODELO / MODEL		G 270 WG ER		G 370 WG ER	
CÓDIGO / CODE / CÓDIGO / CODE		2058.695		2058.698	
<b>Preço / Prix / Precio / Price</b>	€	<b>3.559,00</b>		<b>3.181,00</b>	
Dimensões / Dimensions / Dimensiones	mm	750x700x860		1090x700x350	
Grelhas / Grilles / Rejillas / Grids	nr	2		3	
Consumo de Gás G20 / Cons. Gaz / Cons. Gas / Gas Cons.	m3/h	1,52		1,26	
Consumo de Gás G30-G31 / Cons. Gaz/ Cons. Gas / Gas Gons.	kg/h	0,60		0,60	
Peso Líquido / Poids Net / Peso Neto / Net Weight	kg	46		65	
Potência / Puissance / Potencia / Power	Qn/kW	16		24	







UDI

**GRELHADORES PEDRA VULCÂNICA / VAPOR**  
GRILLES À PIERRE DE LAVE / VAPEUR  
PARRILLAS DE PIEDRA LÁVICA / VAPOR  
VOLCANIC STONE GRILLS / STEAM



Robustos, eficazes e versáteis. Construídos basicamente em aço inox, grelham rapidamente qualquer tipo de carne ou peixe de forma natural, higiénica e prática. A pedra lávica ou carvão vulcânico, sendo um produto poroso, inodoro e não tóxico, constitui um excelente filtro de chama e um bom difusor de calor. Podem ser utilizados também como grelhadores a vapor. Para tal, basta retirar a pedra lávica e colocar água no aparador.



Robustes, efficaces et versatiles. Construits en base d'acier inoxydable, grillent rapidement n'importe quel type de viande ou de poisson de façon naturelle, hygiénique et pratique. De par sa nature poreuse, inodore et non toxique, la pierre volcanique ou charbon volcanique constitue un excellent filtre de flamme et un bon diffuseur de chaleur il peut également être utilisé comme grill à vapeur. Pour cela, il suffit de retirer la pierre volcanique et placer de l'eau dans l'appareil.



Robustos, eficazes y versatiles. Construidos en acero inoxidable, asan rapidamente cualquier tipo de carne o pescado de una forma natural, higiénica y práctica. La piedra lávica o carbón volcánico siendo un producto poroso, inodoro y no tóxico, constituye un excelente filtro de llama, un buen esparcidor del calor. También pueden ser usados como asadores avapor. Para tal, basta retirar la piedra lávica y colocar agua en el aparador.



Sturdy, effective and versatile. Its basic stainless steel construction allows any type of meat or fish to be quickly grilled in a natural, hygienic and practical way. Since the lava stone or volcanic charcoal is porous, odorless and non-toxic, it is an excellent flame filter and good at distributing heat. It can also be used as a steam grill. As such, just remove the lava stone and put water in the sideboard.



MODELO / MODÈLE / MODELO / MODEL	4 GAMB.	
CÓDIGO / CODE / CÓDIGO / CODE	2058.207	
<b>Preço / Prix / Precio / Price</b>	<b>€</b>	<b>6.337,00</b>
Dimensões / Dimensions / Dimensiones	mm	1300x 700x 400
Superfície Útil / Surface Utile / Superficie Util / Working Surface	mm	1200x510
Grelhas / Grilles / Rejillas / Grids	nr	4
Consumo de Gás G20 / Cons. Gaz / Cons. Gas / Gas Gons.	m <sup>3</sup> /h	4,74
Consumo de Gás G30-G31 / Cons. Gaz / Cons. Gas / Gas Cons.	kg/h	3,48
Potência / Puissance / Potencia / Power	Qn/kw	44,8



banca  
plain de travail  
encimera  
worktop



PTBC

BRQ



BR220

MCP



PGN



PTBS



BPF





HOTELARIA • COZINHAS PROFISSIONAIS

HOSPITALITY INDUSTRY  
PROFESSIONAL KITCHENS

# COZINHAS PROFISSIONAIS

# Cook HIT<sup>by</sup> **UDI**<sup>®</sup>

## UM CONCEITO COM ASSINATURA UDI<sup>®</sup>

Dispomos de uma gama de equipamentos Cook HIT muito completa que permite responder às necessidades de todos os tipos de cozinhas profissionais.

A implementação do conceito terá sempre o suporte de uma equipa de Consultores de Projecto UDI<sup>®</sup> para uma maior garantia de sucesso e satisfação.

### PROFESSIONAL KITCHENS

A CONCEPT WITH  
UDI<sup>®</sup> SIGNATURE

We have at your disposal a very complete line of Cook HIT equipment to meet the needs of all types of professional kitchens.

The implementation of the concept will always be supported by a team of Project Consultants from UDI<sup>®</sup>, for a greater assurance of success and satisfaction.

CATÁLOGO  
Cook HIT  
Cook HIT  
CATALOGUE



## 500

Cook HIT 500, a dimensão extremamente compacta da linha satisfaz a necessidade dos restaurantes e snack bares onde o espaço é fator determinante para a escolha, mas sem comprometer a robustez e eficácia garantida pelos potentes queimadores de dupla coroa.

Cook HIT 500: the extremely compact size of the line meets the needs of restaurants and snack bars, where space is a determining factor for choice, but without compromising the robustness and efficiency provided by the powerful double crown burners.

## 600

Cook HIT 600, a linha de bancada é caracterizada pela sua versatilidade, capaz de realizar milagres em pequenos espaços, oferecendo dimensões ideais e máximo desempenho graças a módulos independentes que proporcionam higiene e facilidade de manutenção.

Cook HIT 600: the countertop line is characterized by its versatility, capable of performing miracles in small spaces, offering ideal dimensions and maximum performance thanks to independent modules that ensure good hygiene and easy maintenance.

Exemplo Linha Cook HIT 600  
Example of Cook HIT 600 line



## 700

Cook HIT 700 dá resposta às necessidades de zonas de trabalho funcionais e ergonómicas. Um conceito com soluções para interpretar os espaços limitados ou de pequena dimensão, com suficiente flexibilidade para tornar o seu projecto competitivo.

Cook HIT 700: it meets the needs of functional and ergonomic work areas. A concept with solutions designed to adapt to limited or small spaces, with enough flexibility to make your project a competitive one.

## 900

Cook HIT 900, a necessidade do alto rendimento interpretada pela UDi®. Um conceito capaz de valorizar de forma harmoniosa com a arquitectura do projecto, as exigências de: alta performance, design, ergonomia, versatilidade, potência, fiabilidade, sustentabilidade.

Cook HIT 900: the need for high performance, interpreted by UDi® in an integrated and harmonious way. Its concept is capable of valuing the demands for high performance, design, ergonomics, versatility, power, reliability and sustainability.



Exemplo Linha Cook HIT 700  
Example of Cook HIT 700 line



Exemplo Linha Cook HIT 900  
Example of Cook HIT 900 line

# Cook HIT

## Um conceito com assinatura UDI®

Un concept avec signature UDI®

Un concepto con firma UDI®

A concept with UDI® signature

Para além da tecnologia e performance aplicadas na vasta tipologia de equipamentos que compõem as soluções das suas linhas de cozinha profissional, a **UDI® é uma Atitude de complementaridade à arquitectura do seu projecto**, propondo-lhe a **criação de um ambiente de trabalho adaptado aos actuais desafios de uma equipa profissional**, sem esquecer as exigências do investidor para quem os valores da confiança e rentabilidade são fundamentais.

A implementação do conceito terá sempre o suporte de uma equipa de **Consultores de Projecto UDI® para uma maior garantia de sucesso e satisfação.**

En plus de la technologie et de la performance appliquée dans la vaste typologie des équipements qui composent les solutions de ses lignes de cuisine professionnelle, l'UDI® est une attitude complémentaire à l'architecture de votre projet, vous offrant de créer un environnement de travail adapté aux défis actuels d'une équipe professionnelle, sans oublier les exigences de l'investisseur pour qui les valeurs de confiance et de rentabilité sont fondamentales. La mise en œuvre du concept sera toujours avoir le soutien d'une équipe de projet UDI® Consultants pour une plus grande garantie de succès et de satisfaction.

Además la tecnología y el rendimiento aplicado en la gran tipología de los equipos que constituyen las soluciones de sus líneas de cocina profesional, UDI® es una Actitud complementaria a la arquitectura de su proyecto, que le posibilita crear un entorno de trabajo adaptado a los desafíos actuales de un equipo profesional, sin olvidar las exigencias de lo inversor por lo cual los valores de confianza y rentabilidad son fundamentales. La aplicación del concepto incluye el apoyo de un equipo de Consultoría de Proyecto UDI® para una mayor garantía de éxito y satisfacción.

Besides technology and performance applied in large type of equipment that set up the solutions of its lines of professional kitchen, UDI® is a complementary attitude to the architecture of its project, enabling you to create a working environment adapted to the current challenges of a professional team, without forgetting the demands of investor for which the values of trust and performance are critical.

The implementation of the concept will always have the support of a team by UDI® Consulting Project for a greater guarantee of success and satisfaction.



UDI

**FOGÃO GÁS - COOK HIT 500**  
**CUISINIÈRE A GAZ - COOK HIT 500**  
**COCINA A GAS - COOK HIT 500**  
**GAS STOVE - COOK HIT 500**



Fogão a gás com 2 queimadores com armário aberto, queimadores de alta eficiência, corpo em aço inoxidável, fácil de limpar, design económico, pés ajustáveis.



Cuisinière à gaz à 2 brûleurs avec armoire ouverte, brûleurs à haute efficacité, corps en acier inoxydable, conception économique, pieds réglables.



Cocina a gas con 2 quemadores con armario abierto, quemadores de alta eficiencia, cuerpo de acero inoxidable, fácil de limpiar, diseño económico, pies ajustables.



2 burner gas stove with open cupboard, high efficiency burners, stainless steel body, easy to clean, economical design, adjustable feet.



MODELO / MODÈLE / MODELO / MODEL CÓDIGO / CODE / CÓDIGO / CODE		UDFG5K200G 5500.001
<b>Preço / Prix / Precio / Price</b>	€	<b>1.602,00</b>
Dimensões / Dimensions / Dimensiones	mm	800x575x900
Potência nominal / Puissance nominale / Potência nominal / Rated power	Qn/kW	19
Potência dos queimadores (individual) / Puissance du brûleur (individual) / Potência los quemadores (individual) / Burners Power (individual)	kW	2x10
Entrada gás / Entrée gaz / Entrada gas / Gas inlet		R 1/2"
Volume / Volume / Volumen / Volume	m <sup>3</sup>	0,95
Peso Líquido-Bruto / Poids Net-Brut / Peso Neto-Bruto / Net-Gross Weight	Kg	68-75



MODELO / MODÈLE / MODELO / MODEL CÓDIGO / CODE / CÓDIGO / CODE		UDFG5K201G 5500.003
<b>Preço / Prix / Precio / Price</b>	€	<b>2.100,00</b>
Dimensões / Dimensions / Dimensiones	mm	1200x575x900
Potência nominal / Puissance nominale / Potência nominal / Rated power	Qn/kW	32
Potência dos queimadores (individual) / Puissance du brûleur (individual) / Potência los quemadores (individual) / Burners Power (individual)	kW	3x10
Entrada gás / Entrée gaz / Entrada gas / Gas inlet		R 1/2"
Volume / Volume / Volumen / Volume	m <sup>3</sup>	1,4
Peso Líquido / Poids Net / Peso Neto / Net Weight	Kg	-

### Fogão a gás 3 queimadores com 1 forno a gás

Cuisinière a gaz 3 feux avec 1 four gaz  
 Fogón a gas 3 fuegos con 1 hornos a gas  
 Gas stove with 3 burners and 1 gas ovens



1 grelha e 3 guias com 400x530mm  
 1 grille et 3 guides pour 400x530mm  
 1 rejilla y 3 carriles con 400x530mm  
 1 grid and 3 rails for 400x530mm

MODELO / MODÈLE / MODELO / MODEL CÓDIGO / CODE / CÓDIGO / CODE		UDG5K211G 5500.005
<b>Preço / Prix / Precio / Price</b>	€	<b>3.031,00</b>
Dimensões / Dimensions / Dimensiones	mm	1200x575x900
Potência nominal / Puissance nominale / Potência nominal / Rated power	Qn/kW	32,5
Potência dos queimadores (individual) / Puissance du brûleur (individual) / Potência los quemadores (individual) / Burners Power (individual)	kW	3x10
Entrada gás / Entrée gaz / Entrada gas / Gas inlet		1/2"
Volume / Volume / Volumen / Volume	m <sup>3</sup>	3,418
Peso Líquido / Poids Net / Peso Neto / Net Weight	Kg	-
Dim. forno e potência / Dim. four puissance / Dim. horno y potencia / Oven dim. and power	GN - kW	2x1/1 - 4



**UDS6K100E**  
5600.005

**Fogão elétrico bancada 2 placas redondas**

Cuisinière électrique 2 plaques rondes  
Fogón eléctrico 2 planchas redondas  
2 Rounded plate electric stove



MODELO / MODÈLE / MODELO / MODEL	UDS6K100E	
CÓDIGO / CODE / CÓDIGO / CODE	5600.005	
<b>Preço / Prix / Precio / Price</b>	€	<b>646,00</b>
Dimensões / Dimensions / Dimensiones	mm	300x600x300
Potência total / Puissance total / Potência total / Total power	kW	3
Tensão / Tension / Tension / Tension	V	400
Secções cabo / Sections câbles / Secciones cable / Cable sections	5x2,5-H05RNF	
Dimensões da placa fogão e potência (individual) / Dimensions la plaque poêle et puissance (individuel) / Dimensiones la placa fogón y potencia (individual) / Stove plate dimensions and power (individual)	Ø/kW	Ø150 / 1,5
Volume / Volume / Volumen / Volume	m <sup>3</sup>	0,13
Peso Líquido-Bruto / Poids Net-Brut / Peso Neto-Bruto / Net-Gross Weight	Kg	24

**UDS6K200E**  
5600.010

**Fogão elétrico bancada 4 placas redondas**

Cuisinière électrique 4 plaques rondes  
Fogón eléctrico 4 planchas redondas  
4 Rounded plate electric stove



MODELO / MODÈLE / MODELO / MODEL	UDS6K200E	
CÓDIGO / CODE / CÓDIGO / CODE	5600.010	
<b>Preço / Prix / Precio / Price</b>	€	<b>936,00</b>
Dimensões / Dimensions / Dimensiones	mm	600x600x300
Potência total / Puissance total / Potência total / Total power	kW	6
Tensão / Tension / Tension / Tension	V	400
Secções cabo / Sections câbles / Secciones cable / Cable sections	5x2,5-H05RNF	
Dimensões da placa fogão e potência (individual) / Dimensions la plaque poêle et puissance (individuel) / Dimensiones la placa fogón y potencia (individual) / Stove plate dimensions and power (individual)	Ø/kW	Ø150 / 1,5
Volume / Volume / Volumen / Volume	m <sup>3</sup>	0,26 m <sup>3</sup>
Peso Líquido-Bruto / Poids Net-Brut / Peso Neto-Bruto / Net-Gross Weight	Kg	45





UDI

**FRY-TOPS ELÉTRICOS BANCADA - COOK HIT 600**

GRIDDLES ELECTRIQUES BANC - COOK HIT 600

FRY-TOPS ELÉTRICOS DE BANCO - COOK HIT 600

BENCH ELECTRIC FRY-TOP - COOK HIT 600



**Frytop simples liso**

Frytop simple lise  
Frytop simples liso  
Single smooth frytop



MODELO / MODÈLE / MODELO / MODEL	UDS6I100E	
CÓDIGO / CODE / CÓDIGO / CODE	5600.035	
<b>Preço / Prix / Precio / Price</b>	€	<b>960,00</b>
Dimensões / Dimensions / Dimensiones	mm	300x600x300
Potência total / Puissance total / Potència total / Total power	kW	2,4
Tensão / Tension / Tensión / Tension	V	400
Secções cabo / Sections câbles / Secciones cable / Cable sections	5x2,5 mm <sup>2</sup> H05RNF	
Dimensões da placa / Dimensions la plaque / Dimensiones la placa / Plate dimensions	mm	386x400x12
Volume / Volume / Volumen / Volume	m <sup>3</sup>	0,13
Peso Líquido-Bruto / Poids Net-Brut / Peso Neto-Bruto / Net-Gross Weight	Kg	30

**Frytop duplo liso**

Frytop double lis  
Frytop doble liso  
Double smooth frytop



MODELO / MODÈLE / MODELO / MODEL	UDS6I200E	
CÓDIGO / CODE / CÓDIGO / CODE	5600.040	
<b>Preço / Prix / Precio / Price</b>	€	<b>1.373,00</b>
Dimensões / Dimensions / Dimensiones	mm	600x600x300
Potência total / Puissance total / Potència total / Total power	kW	6
Tensão / Tension / Tensión / Tension	V	400
Secções cabo / Sections câbles / Secciones cable / Cable sections	5x2,5 H05RNF	
Dimensões da placa / Dimensions la plaque / Dimensiones la placa / Plate dimensions	mm	586x400x12
Volume / Volume / Volumen / Volume	m <sup>3</sup>	0,28
Peso Líquido-Bruto / Poids Net-Brut / Peso Neto-Bruto / Net-Gross Weight	Kg	35

**Frytop simples nervurado**

Frytop simple strié  
Frytop simples ranurado  
Single ribbed frytop



MODELO / MODÈLE / MODELO / MODEL	UDS6I100E	
CÓDIGO / CODE / CÓDIGO / CODE	5600.025	
<b>Preço / Prix / Precio / Price</b>	€	<b>1.000,00</b>
Dimensões / Dimensions / Dimensiones	mm	300x600x300
Potência total / Puissance total / Potència total / Total power	kW	2,4
Tensão / Tension / Tensión / Tension	V	400
Secções cabo / Sections câbles / Secciones cable / Cable sections	5x2,5 mm <sup>2</sup> H05RNF	
Dimensões da placa / Dimensions la plaque / Dimensiones la placa / Plate dimensions	mm	386x400x15
Volume / Volume / Volumen / Volume	m <sup>3</sup>	0,13
Peso Líquido-Bruto / Poids Net-Brut / Peso Neto-Bruto / Net-Gross Weight	Kg	28

**Frytop duplo nervurado**

Frytop double strié  
Frytop doble ranurado  
Double ribbed frytop



MODELO / MODÈLE / MODELO / MODEL	UDS6I200E	
CÓDIGO / CODE / CÓDIGO / CODE	5600.030	
<b>Preço / Prix / Precio / Price</b>	€	<b>1.444,00</b>
Dimensões / Dimensions / Dimensiones	mm	600x600x300
Potência total / Puissance total / Potència total / Total power	kW	6
Tensão / Tension / Tensión / Tension	V	400
Secções cabo / Sections câbles / Secciones cable / Cable sections	5x2,5 H05RNF	
Dimensões da placa / Dimensions la plaque / Dimensiones la placa / Plate dimensions	mm	586x400x15
Volume / Volume / Volumen / Volume	m <sup>3</sup>	0,28
Peso Líquido-Bruto / Poids Net-Brut / Peso Neto-Bruto / Net-Gross Weight	Kg	35

**Fritadeira elétrica simples**

Friteuse électrique simple

Freidora eléctrica simple

Single electric fryer



MODELO / MODÈLE / MODELO / MODEL CÓDIGO / CODE / CÓDIGO / CODE		UDS6F100E 5600.015
<b>Preço / Prix / Precio / Price</b>	€	<b>1.203,00</b>
Dimensões / Dimensions / Dimensiones	mm	300x600x300
Potência total / Puissance total / Potência total / Total power	kW	9
Tensão / Tension / Tensión / Tension	V	400
Secções cabo / Sections câbles / Secciones cable / Cable sections		5x2,5 mm <sup>2</sup> H05RNF
Capacidade cuba / Capacité cuve / Capacidad cuba / Tank capacity	L	10
Dimensão cuba / Dimensiones cuve / Dimensiones cuba / Tank dimensions	mm	225x350x235
Dimensões cestos / Dim. paniers / Dim. cestas / Basket dim.	mm	195x265x130
Volume / Volume / Volumen / Volume	m <sup>3</sup>	0,13
Peso Líquido-Bruto / Poids Net-Brut / Peso Neto-Bruto / Net-Gross Weight	Kg	18

**Fritadeira elétrica dupla**

Friteuse électrique double

Freidora eléctrica doble

Double electric fryer



MODELO / MODÈLE / MODELO / MODEL CÓDIGO / CODE / CÓDIGO / CODE		UDS6F200E 5600.020
<b>Preço / Prix / Precio / Price</b>	€	<b>1.926,00</b>
Dimensões / Dimensions / Dimensiones	mm	600x600x300
Potência total / Puissance total / Potência total / Total power	kW	2x9
Tensão / Tension / Tensión / Tension	V	400
Secções cabo / Sections câbles / Secciones cable / Cable sections		5x2,5 mm <sup>2</sup> H05RNF
Capacidade cuba / Capacité cuve / Capacidad cuba / Tank capacity	L	2x10
Dimensão cuba / Dimensiones cuve / Dimensiones cuba / Tank dimensions	mm	225x350x235
Dimensões cestos / Dim. paniers / Dim. cestas / Basket dim.	mm	195x265x130
Volume / Volume / Volumen / Volume	m <sup>3</sup>	0,28
Peso Líquido-Bruto / Poids Net-Brut / Peso Neto-Bruto / Net-Gross Weight	Kg	31



UDI

**FRITADEIRAS GÁS BANCADA - COOK HIT 600**

FRITEUSES GAZ BANC - COOK HIT 600

FREIDORAS GAS DE BANCO - COOK HIT 600

BENCH GAS FRYERS - COOK HIT 600

**Fritadeira gás simples**Friteuse gaz simple  
Freidora gas simple  
Single gas fryer**NOVO  
NOUVEAU  
NUEVO  
NEW**

MODELO / MODÈLE / MODELO / MODEL CÓDIGO / CODE / CÓDIGO / CODE		UDS6F100E 5600.018
<b>Preço / Prix / Precio / Price</b>	<b>€</b>	<b>1.997,00</b>
Dimensões / Dimensions / Dimensiones	mm	400x600x300
Potência total / Puissance total / Potência total / Total power	kW	6
Capacidade cuba / Capacité cuve / Capacidad cuba / Tank capacity	L	8
Dimensões cestos /Dim. paniers /Dim. cestas /Basket dim.	mm	195x290x90
Volume / Volume / Volumen / Volume	m <sup>3</sup>	0,15
Peso Líquido-Bruto /Poids Net-Brut /Peso Neto-Bruto /Net-Gross Weight	Kg	23-25

**Fritadeira gás dupla**Friteuse gaz double  
Freidora gas doble  
Double gas fryer**NOVO  
NOUVEAU  
NUEVO  
NEW**

MODELO / MODÈLE / MODELO / MODEL CÓDIGO / CODE / CÓDIGO / CODE		UDS6F200E 5600.021
<b>Preço / Prix / Precio / Price</b>	<b>€</b>	<b>3.135,00</b>
Dimensões / Dimensions / Dimensiones	mm	800x600x300
Potência total / Puissance total / Potência total / Total power	kW	12
Capacidade cuba / Capacité cuve / Capacidad cuba / Tank capacity	L	2x8
Dimensões cestos /Dim. paniers /Dim. cestas /Basket dim.	mm	2 x 195x290x90
Volume / Volume / Volumen / Volume	m <sup>3</sup>	0,31
Peso Líquido-Bruto /Poids Net-Brut /Peso Neto-Bruto /Net-Gross Weight	Kg	39-43

elétrico  
électrique  
eléctrico  
electricgás  
gaz  
gas  
gas

**UDS6M100E**
**5600.055**
**Cozedor de pasta simples elétrico**

Cuiseur pâte simple électrique

Cocedor pasta simples eléctrico

Electric single pasta cooker

MODELO / MODÈLE / MODELO / MODEL CÓDIGO / CODE / CÓDIGO / CODE		UDS6M100E 5600.055
<b>Preço / Prix / Precio / Price</b>	<b>€</b>	<b>1.092,00</b>
Dimensões / Dimensions / Dimensiones	mm	300x600x300
Potência total / Puissance total / Potência total / Total power	kW	3
Tensão/Tension /Tensión / Tension	V	400
Potência nominal / Puissance nominale / Potência nominal / Rated power	Qn/kW	2,8
Secções cabo / Sections câbles / Secciones cable / Cable sections		5x2,5 H05RNF
Capacidade cuba / Capacite cuve / Capacidad cuba / Tank capacity	L	10
Dimensão cuba /Dimensiones cuve /Dimensiones cuba /Tank dimensions	mm	225x350x235
Dimensões cestos /Dim. paniers /Dim. cestas /Basket dim.	mm	200x90x120 x 3
Volume / Volume / Volumen / Volume	m <sup>3</sup>	0,14
Peso Líquido-Bruto /Poids Net-Brut /Peso Neto-Bruto /Net-Gross Weight	Kg	13



UDI

**BANHOS-MARIA BANCADA - COOK HIT 600**

BAIN-MARIE BANC - COOK HIT 600

BAÑOS MARÍA DE BANCO - COOK HIT 600

BENCH BAIN-MARIE - COOK HIT 600



**UDS6S100E**

**5600.065**

**Banho-maria simples elétrico**

Bain-marie simple électrique

Baño maría simples eléctrico

Single electric bain-marie

MODELO / MODÈLE / MODELO / MODEL	UDS6S100E	
CÓDIGO / CODE / CÓDIGO / CODE	5600.065	
<b>Preço / Prix / Precio / Price</b>	<b>€</b>	<b>826,00</b>
Dimensões / Dimensions / Dimensiones	mm	300x600x300
Potência total / Puissance total / Potência total / Total power	kW	1,5
Tensão / Tension / Tensión / Tension	V	230
Secções cabo / Sections câbles / Secciones cable / Cable sections		3x2,5 H05RNF
Capacidade cuba / Capacité cuve / Capacidad cuba / Tank capacity	L	2,5 LT
Dimensão cuba / Dimensiones cuve / Dimensiones cuba / Tank dimensions	mm	G/N 1/4 - 100 (265x162 mm)
Volume / Volume / Volumen / Volume	m³	0,18
Peso Líquido-Bruto / Poids Net-Brut / Peso Neto-Bruto / Net-Gross Weight	Kg	18



**UDS6T100N**  
**5600.045**

**Elemento neutro simples**

Élément neutre simple

Elemento neutro simples

Single neutral elemento



MODELO / MODÈLE / MODELO / MODEL	UDS6T100N	
CÓDIGO / CODE / CÓDIGO / CODE	5600.045	
<b>Preço / Prix / Precio / Price</b>	<b>€</b>	<b>317,00</b>
Dimensões / Dimensions / Dimensiones	mm	300x600x300
Volume / Volume / Volumen / Volume	m <sup>3</sup>	0,13
Peso Líquido-Bruto / Poids Net-Brut / Peso Neto-Bruto / Net-Gross Weight	Kg	12

**UDS6T200N**  
**5600.050**

**Elemento neutro duplo**

Élément neutre double

Elemento neutro doble

Double neutral elemento



MODELO / MODÈLE / MODELO / MODEL	UDS6T200N	
CÓDIGO / CODE / CÓDIGO / CODE	5600.050	
<b>Preço / Prix / Precio / Price</b>	<b>€</b>	<b>360,00</b>
Dimensões / Dimensions / Dimensiones	mm	600x600x300
Volume / Volume / Volumen / Volume	m <sup>3</sup>	0,28
Peso Líquido-Bruto / Poids Net-Brut / Peso Neto-Bruto / Net-Gross Weight	Kg	15



UDI

**AQUECEDOR DE BATATA FRITA BANCADA - COOK HIT 600**

CHAUFFE POMME DE TERRE BANC - COOK HIT 600

CALENTADOR DE PATATA FRITA DE BANCO - COOK HIT 600

BENCH FRYED CHIP WARMER - COOK HIT 600



**UDS6D100E**

**5600.060**

**Aquecedor de batata frita bancada**

Chauffe pomme de terre banc

Calentador de patata frita de banco

Bench fried chip warmer

MODELO / MODÈLE / MODELO / MODEL	UDS6D100E	
CÓDIGO / CODE / CÓDIGO / CODE	5600.060	
<b>Preço / Prix / Precio / Price</b>	<b>€</b>	<b>631,00</b>
Dimensões / Dimensions / Dimensiones	mm	450x600x300
Potência total / Puissance total / Potência total / Total power	W	850
Tensão / Tension / Tensión / Tension	V	230
Secções cabo / Sections câbles / Secciones cable / Cable sections		3x1,5 H05RNF
Capacidade cuba / Capacité cuve / Capacidad cuba / Tank capacity	L	15
Dimensão cuba / Dimensiones cuve / Dimensiones cuba / Tank dimensions	mm	GN 1/1-150 (530X325)
Dimensões cestos / Dim. paniers / Dim. cestas / Basket dim.	mm	-
Volume / Volume / Volumen / Volume	m <sup>3</sup>	0,16
Peso Líquido-Bruto / Poids Net-Brut / Peso Neto-Bruto / Net-Gross Weight	Kg	17

# Cook HIT 700



**DESAFIE A UDI® A EXPANDIR OS LIMITES DO SEU ESPAÇO!  
ESTA É A MISSÃO DOS NOSSOS CONSULTORES DE PROJECTO UDI®.**

DÉFIEZ L'UDI® DE REPOUSSER LES LIMITES DE VOTRE ESPACE!  
CE EST LA MISSION DE NOS CONSULTANTS PROJETS UDI®.

DESAFÍE A UDI® PARA AMPLIAR LOS LÍMITES DE SU ESPACIO!  
ESTA ES LA MISIÓN DE NUESTROS CONSULTORES DE PROYECTOS UDI®.

CHALLENGE UDI® TO EXPAND THE LIMITS OF YOUR SPACE!  
THIS IS THE MISSION OF OUR PROJECT CONSULTANTS.



**Um conceito com soluções para interpretar os espaços limitados ou de pequena dimensão, com suficiente flexibilidade para tornar o seu projecto competitivo.**

**A linha Cook HIT 700 dá resposta às necessidades de zonas de trabalho funcionais e ergonómicas, integrando-lhes as básicas promessas da marca:**

**DESIGN  
VERSATILIDADE  
HIGH TECH  
FIABILIDADE  
SUSTENTABILIDADE**

Un concept avec des solutions d'interpréter les espaces restreints ou petits, avec suffisamment de souplesse pour faire de votre projet concurrentiel.

La ligne cuisinier à succès 700, répond aux besoins des domaines de travail fonctionnels et ergonomiques, en les intégrant les promesses de base de la marque:

CONCEPTION  
POLYVALENCE  
HAUTE TECHNOLOGIE  
FIABILITÉ  
DURABILITÉ

Un concepto con soluciones para interpretación de los espacios limitados o de pequeñas dimensiones, con flexibilidad suficiente para que su proyecto sea competitivo.

La línea Cook HIT 700, contesta las necesidades funcionales y ergonómicas de las áreas de trabajo, integrándoles las promesas básicas de la marca:

DISEÑO  
VERSATILIDAD  
ALTA TECNOLOGÍA  
FIABILIDAD  
SOSTENIBILIDAD

A concept with solutions for interpreting the limited spaces or small areas, with sufficient flexibility in order to make your project competitive.

The Cook HIT 700 line, answer the needs of functional and ergonomic work areas, integrating the basic promises of the brand:

DESIGN  
VERSATILITY  
HIGH TECHNOLOGY  
RELIABILITY  
SUSTAINABILITY





**BOTÃO**  
Concepção segundo princípios de ergonomia e preocupações de higienização fácil.

**BOUTON**  
Concevoir selon les principes de l'ergonomie et des préoccupations de nettoyage faciles.

**BOTÓN**  
Concepción según principios ergonómicos y preocupaciones de fácil limpieza.

**KNOB**  
Conception by ergonomic principles and easy cleaning concerns.

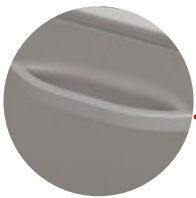

**PUXADOR**  
Design de linhas simples e depuradas.  
Concepção segundo princípios de ergonomia e preocupações de higienização fácil.

**POIGNÉE**  
Concevoir des lignes simples et propres.  
Conception selon les principes de l'ergonomie et des préoccupations de nettoyage faciles.

**TIRADOR**  
Diseño de líneas simples y depuradas.  
Concepción según principios ergonómicos y preocupaciones de fácil limpieza.

**HANDLE**  
Design simple and clean lines.  
Conception by ergonomic principles and easy cleaning concerns.





UDI

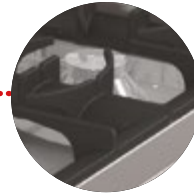

**TABULEIRO DE RECOLHA DE RESÍDUOS**  
 Limpeza e manutenção fáceis  
 Queimadores removíveis  
 Recolha de gorduras e outros resíduos em tabuleiro amovível  
 Acesso facilitado ao interior do equipamento

**BAC DE COLLECTE DES DÉCHETS**  
 Nettoyage et l'entretien  
 Brûleurs amovibles  
 Collecteur des graisses et autres déchets dans le bac amovible  
 Accès facile à l'intérieur de la machine

**BANDEJA COLECTORA DE RESÍDUOS**  
 Limpieza y mantenimiento fácil  
 Quemadores removibles  
 Colección de grasa y otros residuos en bandeja extraíble  
 Fácil acceso al interior de la máquina

**WASTE DRAIN PAN**  
 Cleaning and easy maintenance  
 Removable burners  
 Collector of grease and other waste in removable tray  
 Easy access to the inside of the machine



Queimadores Cromados (Standard)  
 Brûleurs Chrome (Standard)  
 Quemadores De Cromo (Standard)  
 Chrome Burners (Standard)

Equipamentos preparados de série para Gás Natural  
 Equipements préparés en standard pour le gaz naturel  
 Equipos preparados de serie para Gas Natural  
 Equipment prepared as standard for Natural Gas





FOGÕES A GÁS  
CUISINIÈRES A GAZ  
COCINAS A GAS  
GAS RANGE

FOGÕES ELÉTRICOS  
CUISINIÈRES ÉLECTRIQUES  
COCINAS ELÉCTRICAS  
ELECTRIC RANGE

PLACAS ARDENTES A GÁS  
CUISINIÈRES TOUT FOYER GAZ  
PLACAS DE COCINA A GAS  
GAS HOT PLATES

FRY-TOPS A GÁS  
GAS FRY-TOP  
FRY-TOPS A GAS  
GAS FRY-TOP

FRY-TOPS ELÉTRICOS  
GRIDDLES ÉLECTRIQUES  
FRY-TOPS ELÉCTRICOS  
ELECTRIC FRY-TOP

GRELHADORES DE PEDRA LÁVICA A GÁS  
GRILLES A ROCHE LAVIQUE A GAZ  
PARRILLAS DE PIEDRA LÁVICA  
GAS AND LAVA STONE GRILLS

FRITADEIRAS A GÁS  
FRITEUSES GAS  
FREIDORAS A GAS  
GAS FRYERS

FRITADEIRAS ELÉTRICAS  
FRITEUSES ÉLECTRIQUES  
FREIDORAS ELÉCTRICAS  
ELECTRIC FRYERS

AQUECEDOR DE BATATA FRITA  
CHAUFFE POMME DE TERRE  
CALENTADOR DE PATATA FRITA  
FRYED CHIP WARMER

COZEDORES DE PASTA  
CUISEURS A PATES  
COCEDORES DE PASTA  
PASTA COOKERS

BANHOS-MARIA  
BAIN-MARIE  
BAÑOS MARÍA  
BAIN-MARIES

ELEMENTOS NEUTROS  
ÉLÉMENT NEUTRE  
ELEMENTOS NEUTROS  
NEUTRAL UNITS

FRITADEIRAS BASCULANTES ELÉTRICAS/GÁS  
FRITEUSES BASCULANT ÉLECTRIQUE/GAZ  
FREIDORAS BASCULANTES ELÉCTRICAS/GAS  
ELECTRIC/GAS TILTING FRYERS

DESENHOS TÉCNICOS  
DESSINS TECHNIQUES  
DIBUJOS TÉCNICOS  
TECHNICAL DRAWINGS

ACESSÓRIOS E OPCIONAIS  
ACCESSOIRES ET OPTIONNELS  
ACCESORIOS Y OPCIONALES  
OPTIONALS AND SPARE PARTS





UDI

CookHIT  
700

TREMPES  
RÉCHAUDS  
COCINILLAS  
STOVES



Estrutura em Aço Inoxidável 304  
Durável  
Desenho ergonómico  
Fácil de limpar e higiénico



Cadre principal en acier inoxydable 304  
Robuste  
Design ergonomique  
Facile à nettoyer et hygiénique



Estructura de acero inoxidable 304  
Resistente  
Diseño ergonómico  
Fácil de limpiar e higiénico



Stainless steel 304 main frame  
Heavy duty  
Ergonomic design  
Easy to clean and hygienic



NOVO  
NOUVEAU  
NUEVO  
NEW



MODELO / MODÈLE / MODELO / MODEL CÓDIGO / CODE / CÓDIGO / CODE	MONOLUME GÁS 5700.718	
Preço / Prix / Precio / Price	€	1.680,00
Dimensões / Dimensions / Dimensiones	mm	1000x700x900
Peso Líquido-Bruto / Poids Net-Brut / Peso Neto-Bruto / Net-Gross Weight	Kg	49-56
Potência queimadores / Puissance brûleur / Potência quemadores / Burners Power	kW	2x8,5

NOVO  
NOUVEAU  
NUEVO  
NEW



MODELO / MODÈLE / MODELO / MODEL CÓDIGO / CODE / CÓDIGO / CODE	MONOLUME GÁS 5700.720	
Preço / Prix / Precio / Price	€	2.347,00
Dimensões / Dimensions / Dimensiones	mm	1000x700x900
Peso Líquido-Bruto / Poids Net-Brut / Peso Neto-Bruto / Net-Gross Weight	Kg	76-86
Potência queimadores / Puissance brûleur / Potência quemadores / Burners Power	kW	2x8,5



elétrico  
électrique  
eléctrico  
electric



gás  
gaz  
gas  
gas

OPCIONAIS CookHIT 700 / OPTIONNELLES CookHIT 700 / OPCIONALES CookHIT 700 / CookHIT 700 OPTIONALS 204>207

Consulte condições na pág. 6 • Voir conditions dans la page 6 • Ver condiciones en la pág. 6 • Conditions on page 6



**Com armário+porta | Avec armoire+porte | Con armario+puerta | With cupboard+door**

MODELO / MODÈLE / MODELO / MODEL	UDF072APG	
CÓDIGO / CODE / CÓDIGO / CODE	5700.002	
<b>Preço / Prix / Precio / Price</b>	€	<b>1.583,00</b>
Dimensões / Dimensions / Dimensiones	mm	400x730x900
Potência queimadores / Puissance brûleur / Potência quemadores / Burners Power	kW	2x6,5
Peso Líquido / Poids Net / Peso Neto / Net Weight	Kg	50

**Fogão a gás 4 queimadores com 1 forno gás** - Cuisinière a gaz 4 feux avec 1 four gaz  
 Fogón al gas 4 fuegos con 1 horno gas - Gas stove 4 burners with 1 gas oven

MODELO / MODÈLE / MODELO / MODEL	UDF074FG	
CÓDIGO / CODE / CÓDIGO / CODE	5700.008	
<b>Preço / Prix / Precio / Price</b>	€	<b>2.963,00</b>
Dimensões / Dimensions / Dimensiones	mm	800x730x900
Potência queimadores / Puissance brûleur / Potência quemadores / Burners Power	kW	4x6,5
Dim. forno e potência / Dim. four puissance / Dim. horno y potencia / Oven dim. and power		545x645x300 2/1 GN 6 kW
Peso Líquido / Poids Net / Peso Neto / Net Weight	Kg	115

**Fogão a gás 4 queimadores com armário e 2 portas** - Cuisinière a gaz 4 feux avec armoire et 2 portes -  
 Fogón a gas 4 fuegos con armario y 2 puertas - Gas stove 4 burners with cupboard and 2 doors

MODELO / MODÈLE / MODELO / MODEL	UDF074APG	
CÓDIGO / CODE / CÓDIGO / CODE	5700.004	
<b>Preço / Prix / Precio / Price</b>	€	<b>2.092,00</b>
Dimensões / Dimensions / Dimensiones	mm	800x730x800
Potência queimadores / Puissance brûleur / Potência quemadores / Burners Power	kW	4x6,5
Peso Líquido / Poids Net / Peso Neto / Net Weight	Kg	73

**Fogão a gás 6 queimadores + Maxiforno** - Cuisinière a gaz 6 feux + Maxiforno  
 Fogón a gas 6 fuegos + Maxihorno - Gas stove 6 burners + Maxioven

MODELO / MODÈLE / MODELO / MODEL	UDF076FMG	
CÓDIGO / CODE / CÓDIGO / CODE	5700.006	
<b>Preço / Prix / Precio / Price</b>	€	<b>4.579,00</b>
Dimensões / Dimensions / Dimensiones	mm	1200x730x900
Potência queimadores / Puissance brûleur / Potência quemadores / Burners Power	kW	6x6,5
Dim. forno e potência / Dim. four puissance / Dim. horno y potencia / Oven dim. and power		970x645x290 6 kW
Peso Líquido / Poids Net / Peso Neto / Net Weight	Kg	176

**Fogão a gás 6 queimadores com 1 forno a gás\*** - Cuisinière a gaz 6 feux avec 1 four gaz - Fogón a gas 6  
 fuegos con 1 horno a gas - Gas stove 6 burners with 1 gas oven

MODELO / MODÈLE / MODELO / MODEL	UDF076FAPG	
CÓDIGO / CODE / CÓDIGO / CODE	5700.010	
<b>Preço / Prix / Precio / Price</b>	€	<b>4.462,00</b>
Dimensões / Dimensions / Dimensiones	mm	1200x730x900
Potência queimadores / Puissance brûleur / Potência quemadores / Burners Power	kW	6x6,5
Dim. forno e potência / Dim. four puissance / Dim. horno y potencia / Oven dim. and power		545x645x300 2/1 GN 6 kW
Peso Líquido / Poids Net / Peso Neto / Net Weight	Kg	173

**Fogão a gás 6 queimadores com armário e 3 portas** - Cuisinière a gaz 6 feux avec armoire et 3 portes -  
 Fogón a gas 6 fuegos con armario y 3 puertas - Gas stove 6 burners with cupboard and 3 doors

MODELO / MODÈLE / MODELO / MODEL	UDF076APG	
CÓDIGO / CODE / CÓDIGO / CODE	5700.011	
<b>Preço / Prix / Precio / Price</b>	€	<b>3.559,00</b>
Dimensões / Dimensions / Dimensiones	mm	1200x730x900
Potência queimadores / Puissance brûleur / Potência quemadores / Burners Power	kW	6x6,5
Peso Líquido / Poids Net / Peso Neto / Net Weight	Kg	135

**WOK com armário+porta | WOK avec armoire+porte | WOK con armario+puerta | WOK with cupboard+door**

MODELO / MODÈLE / MODELO / MODEL	UDFC7SAPG WOK	
CÓDIGO / CODE / CÓDIGO / CODE	5700.015	
<b>Preço / Prix / Precio / Price</b>	€	<b>1.518,00</b>
Dimensões / Dimensions / Dimensiones	mm	400x730x900
Potência queimadores / Puissance brûleur / Potência quemadores / Burners Power	kW	10
Peso Líquido-Bruto / Poids Net-Brut/ Peso Neto-Bruto / Net-Gross Weight	Kg	45-62



UDI

Cook HIT  
700

**FOGÕES GÁS - COOK HIT 700**  
 CUISINIÈRES A GAZ - COOK HIT 700  
 COCINAS A GAS - COOK HIT 700  
 GAS RANGE - COOK HIT 700



**NOVO**  
 NOUVEAU  
 NUEVO  
 NEW



**Fogão a gás 4 queimadores com 1 forno elétrico** - Cuisinière a gaz 4 feux avec 1 four électrique  
 Fogón al gas 4 fuegos con 1 horno eléctrico - Gas stove 4 burners with 1 electric oven

MODELO / MODÈLE / MODELO / MODEL	UDF074FE
CÓDIGO / CODE / CÓDIGO / CODE	5700.009
<b>Preço / Prix / Precio / Price</b>	€ <b>3.571,00</b>
Dimensões / Dimensions / Dimensiones	mm 800x730x900
Potência queimadores /Puissance brûleur /Potência quemadores /Burners Power	kW 4x6,5
Dim. forno e potência /Dim. four puissance /Dim. horno y potencia /Oven dim. and power	2/1 GN 6 kW
Peso Líquido /Poids Net /Peso Neto /Net Weight	Kg 106

**NOVO**  
 NOUVEAU  
 NUEVO  
 NEW



**Fogão a gás 8 queimadores com armário e 4 portas** - Cuisinière a gaz 8 feux avec armoire et 4 portes -  
 Fogón a gas 8 fuegos con armario y 4 puertas - Gas stove 8 burners with cupboard and 4 doors

MODELO / MODÈLE / MODELO / MODEL	UDF078APG
CÓDIGO / CODE / CÓDIGO / CODE	5700.013
<b>Preço / Prix / Precio / Price</b>	€ <b>5.186,00</b>
Dimensões / Dimensions / Dimensiones	mm 1600x730x900
Potência queimadores /Puissance brûleur /Potência quemadores /Burners Power	kW 8x6,5
Peso Líquido /Poids Net /Peso Neto /Net Weight	Kg 176

**NOVO**  
 NOUVEAU  
 NUEVO  
 NEW



**Fogão a gás 8 queimadores com 2 fornos a gás** - Cuisinière a gaz 8 feux avec 2 fours gaz - Fogón a gas 8  
 fuegos con 2 hornos a gas - Gas stove 8 burners with 2 gas ovens

MODELO / MODÈLE / MODELO / MODEL	UDF078FG
CÓDIGO / CODE / CÓDIGO / CODE	5700.007
<b>Preço / Prix / Precio / Price</b>	€ <b>6.877,00</b>
Dimensões / Dimensions / Dimensiones	mm 1600x730x900
Potência queimadores /Puissance brûleur /Potência quemadores /Burners Power	kW 8x6,5
Dim. forno e potência /Dim. four puissance /Dim. horno y potencia /Oven dim. and power	GN2/1x4 - 6kWx2
Peso Líquido-Bruto / Poids Net-Brut/ Peso Neto-Bruto / Net-Gross Weight	Kg 215-230



elétrico  
 électrique  
 eléctrico  
 electric



gás  
 gaz  
 gas  
 gas

OPCIONAIS CookHIT 700 / OPTIONNELLES CookHIT 700 / OPCIONALES CookHIT 700 / CookHIT 700 OPTIONALS 204>207

Consulte condições na pág. 6 • Voir conditions dans la page 6 • Ver condiciones en la pág. 6 • Conditions on page 6



**Fogão elétrico de placas redondas com armário+porta** - Cuisinière électrique de plaques rondes avec armoire+porte - Fogón eléctrico de plancha redonda con armario+puerta - Rounded plate electric stove with cupboard+door

MODELO / MODÈLE / MODELO / MODEL	UDF072APER
CÓDIGO / CODE / CÓDIGO / CODE	5700.012
<b>Preço / Prix / Precio / Price</b>	€ <b>1.585,00</b>
Dimensões / Dimensions / Dimensiones	mm 400x730x900
Potência total / Puissance total / Potência total / Total power	kW 3,5
Tensão / Tension / Tension / Tension	V 230
Dimensões placa fogão e potência / Dimensions plaque poêle et puissance / Dimensiones placa fogón y potencia / Stove plate dimensions and power	Ø/kW 180 / 1,5 - 200 / 2
Peso Líquido-Bruto / Poids Net-Brut / Peso Neto-Bruto / Net-Gross Weight	Kg 38



**Fogão elétrico de placas redondas com armário+porta** - Cuisinière électrique de plaques rondes avec armoire+porte - Fogón eléctrico de plancha redonda con armario+puerta - Rounded plate electric stove with cupboard+door

MODELO / MODÈLE / MODELO / MODEL	UDF074APER
CÓDIGO / CODE / CÓDIGO / CODE	5700.014
<b>Preço / Prix / Precio / Price</b>	€ <b>2.026,00</b>
Dimensões / Dimensions / Dimensiones	mm 800x730x900
Potência total / Puissance total / Potência total / Total power	kW 7
Tensão / Tension / Tension / Tension	V 400
Dimensões placa fogão e potência / Dimensions plaque poêle et puissance / Dimensiones placa fogón y potencia / Stove plate dimensions and power	Ø/kW 180 / 2X1,5 - 200 / 2X2
Peso Líquido-Bruto / Poids Net-Brut / Peso Neto-Bruto / Net-Gross Weight	Kg 110-130



**Fogão elétrico com forno elétrico** - Cuisinière électrique avec four électrique - Fogón eléctrico con horno eléctrico - Electric stove with electric oven

MODELO / MODÈLE / MODELO / MODEL	UDF074FER
CÓDIGO / CODE / CÓDIGO / CODE	5700.016
<b>Preço / Prix / Precio / Price</b>	€ <b>3.670,00</b>
Dimensões / Dimensions / Dimensiones	mm 800x730x900
Potência total / Puissance total / Potência total / Total power	kW 13
Tensão / Tension / Tension / Tension	V 400
Dimensões do forno e potência / Dimensions four et puissance / Dimensiones del horno y potencia / Oven dimensions and power	mm -kW 545x645x300 / 1x 2/1 GN 6 kW
Dimensões placa fogão e potência / Dimensions plaque poêle et puissance / Dimensiones placa fogón y potencia / Stove plate dimensions and power	Ø/kW 180 / 2X1,5 - 200 / 2X2
Peso Líquido-Bruto / Poids Net-Brut / Peso Neto-Bruto / Net-Gross Weight	Kg 120-140

**NOVO  
NOUVEAU  
NUEVO  
NEW**



**Fogão elétrico placas redondas com armário+porta** - Cuisinière électrique plaques rondes avec armoire+porte - Fogón eléctrico plancha redonda con armario+puerta - Rounded plate electric stove with cupboard+door

MODELO / MODÈLE / MODELO / MODEL	UDF076APE
CÓDIGO / CODE / CÓDIGO / CODE	5700.130
<b>Preço / Prix / Precio / Price</b>	€ <b>2.762,00</b>
Dimensões / Dimensions / Dimensiones	mm 1200x730x900
Potência total / Puissance total / Potência total / Total power	kW 12,3
Tensão / Tension / Tension / Tension	V 400
Dimensões placa fogão e potência / Dimensions plaque poêle et puissance / Dimensiones placa fogón y potencia / Stove plate dimensions and power	Ø/kW 180 / 1,85kW x 3 / 200 / 2,25kW x 3
Peso Líquido-Bruto / Poids Net-Brut / Peso Neto-Bruto / Net-Gross Weight	Kg 111-123

**NOVO  
NOUVEAU  
NUEVO  
NEW**



**Fogão elétrico com forno elétrico** - Cuisinière électrique avec four électrique - Fogón eléctrico con horno eléctrico - Electric stove with electric oven

MODELO / MODÈLE / MODELO / MODEL	UDF076FAP
CÓDIGO / CODE / CÓDIGO / CODE	5700.132
<b>Preço / Prix / Precio / Price</b>	€ <b>4.073,00</b>
Dimensões / Dimensions / Dimensiones	mm 1200x730x900
Potência total / Puissance total / Potência total / Total power	kW 18
Tensão / Tension / Tension / Tension	V 400
Dimensões do forno e potência / Dimensions four et puissance / Dimensiones del horno y potencia / Oven dimensions and power	mm -kW 545x645x300 / 1x 2/1 GN 6 kW
Dimensões placa fogão e potência / Dimensions plaque poêle et puissance / Dimensiones placa fogón y potencia / Stove plate dimensions and power	Ø/kW 180 / 1,85kW x 3 / 200 / 2,25kW x 3
Peso Líquido-Bruto / Poids Net-Brut / Peso Neto-Bruto / Net-Gross Weight	Kg 145-





UDI

Cook HIT  
700**PLACAS ARDENTES GÁS - COOK HIT 700**

CUISINIÈRES TOUT FOYER GAZ - COOK HIT 700

PLACAS DE COCINA A GAS - COOK HIT 700

GAS HOT PLATES - COOK HIT 700

**UDPA7APG**

5700.018

**Placa ardente gás com armário+porta**

Cuisinière gaz avec armoire+porte

Placa a gas con armario+puerta

Gas plate stove with cupboard+door



MODELO / MODÈLE / MODELO / MODEL	UDPA7APG	
CÓDIGO / CODE / CÓDIGO / CODE	5700.018	
<b>Preço / Prix / Precio / Price</b>	<b>€</b>	<b>2.575,00</b>
Dimensões / Dimensions / Dimensiones	mm	800x730x900
Potência nominal / Puissance nominale / Potência nominal / Rated power	Qn/kW	5
Potência queimadores / Puissance brûleur / Potência quemadores / Burners Power	kW	5
Consumo de gás / Consommation de gaz / Consumo gas / Gas Consumption G20	m <sup>3</sup> /h	0,53
Entrada de gás / Entrée de gaz / Entrada gas / Gas inlet		R 1/2"
Consumo de gás / Consommation de gaz G30/G31 / Consumo gas / Gas consumption G30/G31	Kg/h	0,39
Dim. forno e potência / Dim. four puissance / Dim. horno y potencia / Oven dim. and power	mm- kW	-
Dimensões da placa de fogão / Dimensions de la plaque de poêle / Dimensiones de la placa fogón / Stove plate dimensions	mm	750x500
Volume / Volume / Volume / Volume	m <sup>3</sup>	0,75
Peso Líquido-Bruto / Poids Net-Brut / Peso Neto-Bruto / Net-Gross Weight	Kg	145

**UDPA7FG**

5700.020

**Placa ardente gás com forno a gás**

Cuisinière gaz avec four gaz

Placa a gas con horno a gas

Gas plate stove with gas oven



MODELO / MODÈLE / MODELO / MODEL	UDPA7FG	
CÓDIGO / CODE / CÓDIGO / CODE	5700.020	
<b>Preço / Prix / Precio / Price</b>	<b>€</b>	<b>3.337,00</b>
Dimensões / Dimensions / Dimensiones	mm	800x730x900
Potência nominal / Puissance nominale / Potência nominal / Rated power	Qn/kW	11
Potência queimadores / Puissance brûleur / Potência quemadores / Burners Power	kW	5
Consumo de gás / Consommation de gaz / Consumo gas / Gas Consumption G20	m <sup>3</sup> /h	1,16
Entrada de gás / Entrée de gaz / Entrada gas / Gas inlet		R 1/2"
Consumo de gás / Consommation de gaz G30/G31 / Consumo gas / Gas consumption G30/G31	Kg/h	0,85
Dim. forno e potência / Dim. four puissance / Dim. horno y potencia / Oven dim. and power	mm- kW	545x645x300 1x 2/1GN 6 kW
Dimensões da placa de fogão / Dimensions de la plaque de poêle / Dimensiones de la placa fogón / Stove plate dimensions	mm	750x500
Volume / Volume / Volume / Volume	m <sup>3</sup>	0,75
Peso Líquido-Bruto / Poids Net-Brut / Peso Neto-Bruto / Net-Gross Weight	Kg	160-180



sob pedido  
sur demande  
bajo pedido  
on request

**NOVO**  
**NOUVEAU**  
**NUEVO**  
**NEW**



MODELO / MODÈLE / MODELO / MODEL CÓDIGO / CODE / CÓDIGO / CODE	UDFWI7APE WOK 5700.017
<b>Preço / Prix / Precio / Price</b>	<b>€ 8.047.00</b>
Dimensões / Dimensions / Dimensiones	mm 400x730x900
Potência total / Puissance total / Potência total / Total power	kW 5
Tensão / Tension / Tension / Tension	V 230
Peso Líquido-Bruto / Poids Net-Brut / Peso Neto-Bruto / Net-Gross Weight	Kg 48

**NOVO**  
**NOUVEAU**  
**NUEVO**  
**NEW**



MODELO / MODÈLE / MODELO / MODEL CÓDIGO / CODE / CÓDIGO / CODE	UDFI72APE 5700.023
<b>Preço / Prix / Precio / Price</b>	<b>€ 8.114.00</b>
Dimensões / Dimensions / Dimensiones	mm 400x730x900
Potência total / Puissance total / Potência total / Total power	kW 7
Tensão / Tension / Tension / Tension	V 230
Peso Líquido-Bruto / Poids Net-Brut / Peso Neto-Bruto / Net-Gross Weight	Kg 36

**NOVO**  
**NOUVEAU**  
**NUEVO**  
**NEW**



MODELO / MODÈLE / MODELO / MODEL CÓDIGO / CODE / CÓDIGO / CODE	UDFI74APE 5700.025
<b>Preço / Prix / Precio / Price</b>	<b>€ 15.393.00</b>
Dimensões / Dimensions / Dimensiones	mm 800x730x900
Potência total / Puissance total / Potência total / Total power	kW 14
Tensão / Tension / Tension / Tension	V 400
Peso Líquido-Bruto / Poids Net-Brut / Peso Neto-Bruto / Net-Gross Weight	Kg 57



UDI

Cook HIT  
700**FOGÃO COM PLACA ARDENTE GÁS - COOK HIT 700**

CUISINIÈRES TOUT FOYER GAZ - COOK HIT 700

FOGÓN CON PLACAS DE COCINA A GAS - COOK HIT 700

OVEN WITH GAS HOT PLATES - COOK HIT 700

**NOVO**  
**NOUVEAU**  
**NUEVO**  
**NEW****Placa ardente gás com armário+porta**

Cuisinière gaz avec armoire+porte

Placa a gas con armario+puerta

Gas plate stove with cupboard+door

MODELO / MODÈLE / MODELO / MODEL	UDFPA74APG	
CÓDIGO / CODE / CÓDIGO / CODE	5700.019	
<b>Preço / Prix / Precio / Price</b>	€	<b>4.631.00</b>
Dimensões / Dimensions / Dimensiones	mm	1200x730x900
Potência / Puissance / Potência / Power	kW	32,3
Potência dos queimadores (individual) / Puissance du brûleur / Potência de los quemadores / Burners Power	kW	6,5
Entrada de gás / Entrée de gaz / Entrada gas / Gas inlet		R 1/2"
Dim. forno e potência / Dim. four puissance / Dim. horno y potencia / Oven dim. and power	mm- kW	-
Dimensões da placa de fogão / Dimensions de la plaque de poêle / Dimensiones de la placa fogón / Stove plate dimensions	mm	750x500
Peso Líquido-Bruto / Poids Net-Brut / Peso Neto-Bruto / Net-Gross Weight	Kg	129

**NOVO**  
**NOUVEAU**  
**NUEVO**  
**NEW****Com forno a gás**

Avec four gaz

Con horno a gas

With gas oven

MODELO / MODÈLE / MODELO / MODEL	UDFPA74FGAP	
CÓDIGO / CODE / CÓDIGO / CODE	5700.021	
<b>Preço / Prix / Precio / Price</b>	€	<b>5.930,00</b>
Dimensões / Dimensions / Dimensiones	mm	1200x730x900
Potência / Puissance / Potência / Power	kW	39,5
Potência dos queimadores (individual) / Puissance du brûleur / Potência de los quemadores / Burners Power	kW	6,5
Entrada de gás / Entrée de gaz / Entrada gas / Gas inlet		R 1/2"
Dim. forno e potência / Dim. four puissance / Dim. horno y potencia / Oven dim. and power	mm- kW	545x645x300 1x 2/1GN 6 kW
Dimensões da placa de fogão / Dimensions de la plaque de poêle / Dimensiones de la placa fogón / Stove plate dimensions	mm	750x500
Peso Líquido-Bruto / Poids Net-Brut / Peso Neto-Bruto / Net-Gross Weight	Kg	175

**Frytop simples liso\*** - Frytop simple lise - Frytop simples liso - Single smooth frytop

MODELO / MODÈLE / MODELO / MODEL CÓDIGO / CODE / CÓDIGO / CODE		UDFT7SLAPG 5700.022	UDFT7SLAPG 5700.022C
<b>Preço / Prix / Precio / Price</b>	€	<b>1.632,00</b>	<b>2.075,00</b>
Dimensões / Dimensions / Dimensiones	mm	400x730x900	400x730x900
Potência nominal / Puissance nominale / Potência nominal / Rated power	Qn/kw	6,5	6,5
Potência queimadores / Puissance brûleur / Potência quemadores / Burners Power	kw	6	6
Dimensões da placa / Dimensions de la plaque / Dimensiones de la placa / Plate dimensions	mm	392x500x15	392x500x15
Peso Líquido / Poids Net / Peso Neto / Net Weight	Kg	75	75

\* Com armário+porta | Avec armoire+porte | Con armario+puerta | With cupboard+door

Placa de Cromoduro  
Placa en Cromo duro  
Plaque Chrome Dur  
Hard Chrome Plate

**Frytop simples nervurado\*** - Frytop simple strié - Frytop simples ranurado - Single ribbed frytop

MODELO / MODÈLE / MODELO / MODEL CÓDIGO / CODE / CÓDIGO / CODE		UDFT7SNAPG 5700.026
<b>Preço / Prix / Precio / Price</b>	€	<b>2.067,00</b>
Dimensões / Dimensions / Dimensiones	mm	400x730x900
Potência nominal / Puissance nominale / Potência nominal / Rated power	Qn/kw	6,5
Potência queimadores / Puissance brûleur / Potência quemadores / Burners Power	kw	6
Dimensões da placa / Dimensions de la plaque / Dimensiones de la placa / Plate dimensions	mm	392x500x15
Peso Líquido-Bruto / Poids Net-Brut / Peso Neto-Bruto / Net-Gross Weight	Kg	80-95

\* Com armário+porta | Avec armoire+porte | Con armario+puerta | With cupboard+door

**Frytop duplo liso\*** - Frytop double lise - Frytop doble liso - Double smooth frytop

MODELO / MODÈLE / MODELO / MODEL CÓDIGO / CODE / CÓDIGO / CODE		UDFT7DLAPG 5700.030	UDFT7DLAPG 5700.030C
<b>Preço / Prix / Precio / Price</b>	€	<b>2.327,00</b>	<b>2.985,00</b>
Dimensões / Dimensions / Dimensiones	mm	800x730x900	800x730x900
Potência nominal / Puissance nominale / Potência nominal / Rated power	Qn/kw	13	13
Potência queimadores / Puissance brûleur / Potência quemadores / Burners Power	kw	2x6	2x6
Dimensões da placa / Dimensions de la plaque / Dimensiones de la placa / Plate dimensions	mm	792x500x15	792x500x15
Peso Líquido / Poids Net / Peso Neto / Net Weight	Kg	106	106

\* Com armário+porta | Avec armoire+porte | Con armario+puerta | With cupboard+door

Placa de Cromoduro  
Placa en Cromo duro  
Plaque Chrome Dur  
Hard Chrome Plate

**Frytop duplo nervurado\*** - Frytop double strié - Frytop doble ranurado - Double ribbed frytop

MODELO / MODÈLE / MODELO / MODEL CÓDIGO / CODE / CÓDIGO / CODE		UDFT7DNAPG 5700.034
<b>Preço / Prix / Precio / Price</b>	€	<b>2.683,00</b>
Dimensões / Dimensions / Dimensiones	mm	800x730x900
Potência nominal / Puissance nominale / Potência nominal / Rated power	Qn/kw	13
Potência queimadores / Puissance brûleur / Potência quemadores / Burners Power	kw	2x6
Dimensões da placa / Dimensions de la plaque / Dimensiones de la placa / Plate dimensions	mm	792x500x15
Peso Líquido / Poids Net / Peso Neto / Net Weight	Kg	106

\* Com armário+porta | Avec armoire+porte | Con armario+puerta | With cupboard+door

**Frytop duplo misto** - Frytop double mixte - Frytop doble mixto Double combi frytop

MODELO / MODÈLE / MODELO / MODEL CÓDIGO / CODE / CÓDIGO / CODE		UDFT7DAPG 5700.038	UDFT7DAPG 5700.038C
<b>Preço / Prix / Precio / Price</b>	€	<b>2.397,00</b>	<b>3.270,00</b>
Dimensões / Dimensions / Dimensiones	mm	800x730x900	800x730x900
Potência nominal / Puissance nominale / Potência nominal / Rated power	Qn/kw	13	13
Potência queimadores / Puissance brûleur / Potência quemadores / Burners Power	kw	2x6	2x6
Dimensões da placa / Dimensions de la plaque / Dimensiones de la placa / Plate dimensions	mm	792x500x15	792x500x15
Peso Líquido / Poids Net / Peso Neto / Net Weight	Kg	106	106

\* Com armário+porta | Avec armoire+porte | Con armario+puerta | With cupboard+door

Placa de Cromoduro  
Placa en Cromo duro  
Plaque Chrome Dur  
Hard Chrome Plate

Cook HIT  
700**FRY-TOPS ELÉTRICOS - COOK HIT 700**

GRIDDLES ELECTRIQUES - COOK HIT 700

FRY-TOPS ELÉTRICOS - COOK HIT 700

ELECTRIC FRY-TOP - COOK HIT 700

**Frytop simples liso\*** - Frytop simple lise - Frytop simples liso - Single smooth frytop

MODELO / MODÈLE / MODELO / MODEL	UDFT7SLAPE	
CÓDIGO / CODE / CÓDIGO / CODE	5700.024	
<b>Preço / Prix / Precio / Price</b>	€	<b>1.894,00</b>
Dimensões / Dimensions / Dimensiones	mm	400x730x900
Potência total / Puissance total / Potência total / Total power	kW	3,6
Tensão / Tension / Tensión / Tension	V	400
Dimensões da placa / Dimensions de la plaque / Dimensiones de la placa / Plate dimensions	mm	392x500x15
Peso Líquido-Bruto / Poids Net-Brut / Peso Neto-Bruto / Net-Gross Weight	Kg	80/95

\* Com armário+porta | Avec armoire+porte | Con armario+puerta | With cupboard+door

**Frytop simples nervurado\*** - Frytop simple strié - Frytop simples ranurado - Single ribbed frytop

MODELO / MODÈLE / MODELO / MODEL	UDFT7SNAPE	
CÓDIGO / CODE / CÓDIGO / CODE	5700.028	
<b>Preço / Prix / Precio / Price</b>	€	<b>2.109,00</b>
Dimensões / Dimensions / Dimensiones	mm	400x730x900
Potência total / Puissance total / Potência total / Total power	kW	3,6
Tensão / Tension / Tensión / Tension	V	400
Dimensões da placa / Dimensions de la plaque / Dimensiones de la placa / Plate dimensions	mm	392x500x15
Peso Líquido-Bruto / Poids Net-Brut / Peso Neto-Bruto / Net-Gross Weight	Kg	80

\* Com armário+porta | Avec armoire+porte | Con armario+puerta | With cupboard+door

**Frytop duplo liso\*** - Frytop double lise - Frytop doble liso - Double smooth frytop

MODELO / MODÈLE / MODELO / MODEL	UDFT7DLAPE	UDFT7DLAPE
CÓDIGO / CODE / CÓDIGO / CODE	5700.032	5700.032C
<b>Preço / Prix / Precio / Price</b>	€	<b>2.388,00</b>
Dimensões / Dimensions / Dimensiones	mm	800x730x900
Potência total / Puissance total / Potência total / Total power	kW	7,2
Tensão / Tension / Tensión / Tension	V	400
Dimensões da placa / Dimensions de la plaque / Dimensiones de la placa / Plate dimensions	mm	792x500x15
Peso Líquido-Bruto / Poids Net-Brut / Peso Neto-Bruto / Net-Gross Weight	Kg	120/140

Placa de Cromoduro  
Placa en Cromo duro  
Plaque Chrome Dur  
Hard Chrome Plate

\* Com armário+porta | Avec armoire+porte | Con armario+puerta | With cupboard+door

**Frytop duplo nervurado\*** - Frytop double strié - Frytop doble ranurado - Double ribbed frytop

MODELO / MODÈLE / MODELO / MODEL	UDFT7DNAPE	
CÓDIGO / CODE / CÓDIGO / CODE	5700.036	
<b>Preço / Prix / Precio / Price</b>	€	<b>2.732,00</b>
Dimensões / Dimensions / Dimensiones	mm	800x730x900
Potência total / Puissance total / Potência total / Total power	kW	7,2
Tensão / Tension / Tensión / Tension	V	400
Dimensões da placa / Dimensions de la plaque / Dimensiones de la placa / Plate dimensions	mm	792x500x15
Peso Líquido-Bruto / Poids Net-Brut / Peso Neto-Bruto / Net-Gross Weight	Kg	120/140

\* Com armário+porta | Avec armoire+porte | Con armario+puerta | With cupboard+door

**Frytop duplo misto** - Frytop double mixte - Frytop doble mixto Double combi frytop

MODELO / MODÈLE / MODELO / MODEL	UDFT7DMAPE	
CÓDIGO / CODE / CÓDIGO / CODE	5700.040	
<b>Preço / Prix / Precio / Price</b>	€	<b>2.428,00</b>
Dimensões / Dimensions / Dimensiones	mm	800x730x900
Potência total / Puissance total / Potência total / Total power	kW	7,2
Tensão / Tension / Tensión / Tension	V	400
Dimensões da placa / Dimensions de la plaque / Dimensiones de la placa / Plate dimensions	mm	792x500x15
Peso Líquido-Bruto / Poids Net-Brut / Peso Neto-Bruto / Net-Gross Weight	Kg	120-140

\* Com armário+porta | Avec armoire+porte | Con armario+puerta | With cupboard+door

OPCIONAIS CookHIT 700 / OPTIONNELLES CookHIT 700 / OPCIONALES CookHIT 700 / CookHIT 700 OPTIONALS 204&gt;207

Consulte condições na pág. 6 • Voir conditions dans la page 6 • Ver condiciones en la pág. 6 • Conditions on page 6

181



MODELO / MODÈLE / MODELO / MODEL CÓDIGO / CODE / CÓDIGO / CODE	UDGA7SAPG 5700.074
<b>Preço / Prix / Precio / Price</b>	€ <b>2.184,00</b>
Dimensões / Dimensions / Dimensiones	mm 400x730x900
Peso Líquido-Bruto / Poids Net-Brut / Peso Neto-Bruto / Net-Gross Weight	Kg 80-105

\* **Com armário+porta** | Avec armoire+porte | Con armario+puerta | With cupboard+door

MODELO / MODÈLE / MODELO / MODEL CÓDIGO / CODE / CÓDIGO / CODE	UDGA7DAPG 5700.076
<b>Preço / Prix / Precio / Price</b>	€ <b>3.539,00</b>
Dimensões / Dimensions / Dimensiones	mm 800x730x900
Peso Líquido-Bruto / Poids Net-Brut / Peso Neto-Bruto / Net-Gross Weight	Kg 152-170

\* **Com armário+porta** | Avec armoire+porte | Con armario+puerta | With cupboard+door

**GRELHADORES DE PEDRA LÁVICA GÁS - COOK HIT 700**

 GRILLES A ROCHE LAVIQUE A GAZ - COOK HIT 700  
 PARRILAS DE PIEDRA LÁVICA A GAS - COOK HIT 700  
 GAS GRILLS AND LAVA STONE - COOK HIT 700

MODELO / MODÈLE / MODELO / MODEL CÓDIGO / CODE / CÓDIGO / CODE	UDGPL7SAPG 5700.068
<b>Preço / Prix / Precio / Price</b>	€ <b>2.115,00</b>
Dimensões / Dimensions / Dimensiones	mm 400x730x900
Peso Líquido-Bruto / Poids Net-Brut / Peso Neto-Bruto / Net-Gross Weight	Kg 62-76

\* **Com armário+porta** | Avec armoire+porte | Con armario+puerta | With cupboard+door

MODELO / MODÈLE / MODELO / MODEL CÓDIGO / CODE / CÓDIGO / CODE	UDGPL7DAPG 5700.070
<b>Preço / Prix / Precio / Price</b>	€ <b>2.670,00</b>
Dimensões / Dimensions / Dimensiones	mm 800x730x900
Peso Líquido-Bruto / Poids Net-Brut / Peso Neto-Bruto / Net-Gross Weight	Kg 118-128

\* **Com armário+porta** | Avec armoire+porte | Con armario+puerta | With cupboard+door



UDI

Cook HIT  
700

FRITADEIRAS GÁS - COOK HIT 700

FRITEUSES GAS - COOK HIT 700

FREIDORAS A GAS - COOK HIT 700

GAS FRYERS - COOK HIT 700



**Standard: Simples 2-1/2 Cestos | Dupla: 4-1/2 Cestos (140x280x130)** | Standard: Simple 2-1/2 Panier | Double: 4-1/2 Panier (140x280x130) |  
Standard: Simples 2-1/2 Cestas | Doble: 4-1/2 Cestas (140x280x130) | Standard: Single 2-1/2 Basket | Double: 4-1/2 Basket (140x280x130)



MODELO / MODÈLE / MODELO / MODEL CÓDIGO / CODE / CÓDIGO / CODE		UDFR718APG 5700.044
<b>Preço / Prix / Precio / Price</b>	€	<b>2.380,00</b>
Dimensões / Dimensions / Dimensiones	mm	400x730x900
Potência queimadores / Puissance brûleur / Potência quemadores / Burners Power	kW	3x5
Capacidade cuba / Capacité cuve / Capacidad cuba / Tank capacity	lt	15
Dimensão cuba / Dimensiones cuve / Dimensiones cuba / Tank dimensions	mm	300x345x290
Dimensões cestos / Dim. paniers / Dim. cestas / Basket dim.	mm	2 x140x280x130
Peso Líquido-Bruto / Poids Net-Brut / Peso Neto-Bruto / Net-Gross Weight	Kg	43

\* Com armário+porta | Avec armoire+porte | Con armario+puerta | With cupboard+door



MODELO / MODÈLE / MODELO / MODEL CÓDIGO / CODE / CÓDIGO / CODE		UDFR718DAPG 5700.048
<b>Preço / Prix / Precio / Price</b>	€	<b>3.902,00</b>
Dimensões / Dimensions / Dimensiones	mm	800x730x900
Potência queimadores / Puissance brûleur / Potência quemadores / Burners Power	kW	6x5
Capacidade cuba / Capacité cuve / Capacidad cuba / Tank capacity	lt	15+15
Dimensão cuba / Dimensiones cuve / Dimensiones cuba / Tank dimensions	mm	2 x 300x345x290
Dimensões cestos / Dim. paniers / Dim. cestas / Basket dim.	mm	4 x 140x280x130
Peso Líquido-Bruto / Poids Net-Brut / Peso Neto-Bruto / Net-Gross Weight	Kg	73

\* Com armário+porta | Avec armoire+porte | Con armario+puerta | With cupboard+door



Standard: Simples 2-1/2 Cestos | Dupla: 4-1/2 Cestos (140x280x170) | Standard: Simple 2-1/2 Panier | Double: 4-1/2 Panier (140x280x170) |  
Standard: Simples 2-1/2 Cestas | Doble: 4-1/2 Cestas (140x280x170) | Standard: Single 2-1/2 Basket | Double: 4-1/2 Basket (140x280x170)

NOVO  
NOUVEAU  
NUEVO  
NEW



MODELO / MODÈLE / MODELO / MODEL CÓDIGO / CODE / CÓDIGO / CODE		UDFR710APE 5700.041	UDFR718APE 5700.042
<b>Preço / Prix / Precio / Price</b>	€	<b>1.980,00</b>	<b>2.025,00</b>
Dimensões / Dimensions / Dimensiones	mm	400x730x900	400x730x900
Potência total / Puissance total / Potência total / Total power	kW	7,5	15
Tensão / Tension / Tensión / Tension	V	400	400
Capacidade cuba / Capacité cuve / Capacidad cuba / Tank capacity	L	10	18
Dimensão cuba / Dimensiones cuve / Dimensiones cuba / Tank dimensions	mm	-	300x365x260
Dimensões cestos / Dim. paniers / Dim. cestas / Basket dim.	mm	200x260x115	2 x 140x280x170
Peso Líquido-Bruto / Poids Net-Brut / Peso Neto-Bruto / Net-Gross Weight	Kg	53	48/55

\* Com armário+porta | Avec armoire+porte | Con armario+puerta | With cupboard+door

NOVO  
NOUVEAU  
NUEVO  
NEW



MODELO / MODÈLE / MODELO / MODEL CÓDIGO / CODE / CÓDIGO / CODE		UDFR718DAPE 5700.045	UDFR718DAPE 5700.046
<b>Preço / Prix / Precio / Price</b>	€	<b>3.262,00</b>	<b>3.478,00</b>
Dimensões / Dimensions / Dimensiones	mm	800x730x900	800x730x900
Potência total / Puissance total / Potência total / Total power	kW	15	30
Tensão / Tension / Tensión / Tension	V	400	400
Capacidade cuba / Capacité cuve / Capacidad cuba / Tank capacity	L	10+10	18+18
Dimensão cuba / Dimensiones cuve / Dimensiones cuba / Tank dimensions	mm	-	2 x 300x365x260
Dimensões cestos / Dim. paniers / Dim. cestas / Basket dim.	mm	200x260x115x2	4 x 140x280x170
Peso Líquido-Bruto / Poids Net-Brut / Peso Neto-Bruto / Net-Gross Weight	Kg	81	76/86

\* Com armário+porta | Avec armoire+porte | Con armario+puerta | With cupboard+door

## AQUECEDOR DE BATATA FRITA COM ARMÁRIO+PORTA

CHAUFFE POMME DE TERRE AVEC ARMOIRE+PORTE

CALENTADOR DE PATATA FRITA CON ARMARIO+PUERTA

FRYED CHIP WARMER WITH CUPBOARD+DOOR



MODELO / MODÈLE / MODELO / MODEL CÓDIGO / CODE / CÓDIGO / CODE		UDABF7APE 5700.050
<b>Preço / Prix / Precio / Price</b>	€	<b>1.385,00</b>
Dimensões / Dimensions / Dimensiones	mm	400x730x900
Potência total / Puissance total / Potência total / Total power	kW	0,85
Tensão / Tension / Tensión / Tension	V	230
Secções cabo / Sections câbles / Secciones de cable / Cable sections		3x1,5 mm <sup>2</sup> H05RNF
Capacidade cuba / Capacité cuve / Capacidad cuba / Tank capacity	L	21
Dimensão cuba / Dimensiones cuve / Dimensiones cuba / Tank dimensions	mm	GN 1/1x150
Volume / Volume / Volume / Volume	m <sup>3</sup>	0,45
Peso Líquido-Bruto / Poids Net-Brut / Peso Neto-Bruto / Net-Gross Weight	Kg	55/65

\* Com armário+porta | Avec armoire+porte | Con armario+puerta | With cupboard+door





UDI

Cook HIT  
700

COZEDORES DE PASTA - COOK HIT 700

CUISEURS A PATES - COOK HIT 700

COCEDORES DE PASTA - COOK HIT 700

PASTA COOKERS - COOK HIT 700

**Cozedor de pasta simples a gás**Cuiser pâte simple a gaz  
Cocedor pasta simples a gas  
Gas single pasta cooker

MODELO / MODÈLE / MODELO / MODEL CÓDIGO / CODE / CÓDIGO / CODE		UDCP7SAPG 5700.057
<b>Preço / Prix / Precio / Price</b>	€	<b>2.085,00</b>
Dimensões / Dimensions / Dimensiones	mm	400x730x900
Potência total / Puissance total / Potência total / Total power	kW	8
Capacidade cuba / Capacité cuve / Capacidad cuba / Tank capacity	L	22
Dimensão cuba / Dimensiones cuve / Dimensiones cuba / Tank dimensions	mm	247x400x300
Dimensões cestos / Dim. paniers / Dim. cestas / Basket dim.	mm	2 x 110x160x235 1 x 220x180x235
Peso Líquido-Bruto / Poids Net-Brut / Peso Neto-Bruto / Net-Gross Weight	Kg	67-74

\* Com armário+porta | Avec armoire+porte | Con armario+puerta | With cupboard+door

**Cozedor de pasta simples elétrico\***Cuiser pâte simple électrique  
Cocedor pasta simples eléctrico  
Electric single pasta cooker

MODELO / MODÈLE / MODELO / MODEL CÓDIGO / CODE / CÓDIGO / CODE		UDCP7SAPE 5700.058
<b>Preço / Prix / Precio / Price</b>	€	<b>2.087,00</b>
Dimensões / Dimensions / Dimensiones	mm	400x730x900
Potência total / Puissance total / Potência total / Total power	kW	10
Tensão/Tension Tensión / Tension	V	400
Capacidade cuba / Capacité cuve / Capacidad cuba / Tank capacity	L	22
Dimensão cuba / Dimensiones cuve / Dimensiones cuba / Tank dimensions	mm	300x365x260
Dimensões cestos / Dim. paniers / Dim. cestas / Basket dim.	mm	2 x 120x160x200 1 x 220x170x200
Peso Líquido-Bruto / Poids Net-Brut / Peso Neto-Bruto / Net-Gross Weight	Kg	42

\* Com armário+porta | Avec armoire+porte | Con armario+puerta | With cupboard+door

**Cozedor de pasta duplo elétrico\***Cuiser pâte double électrique  
Cocedor pasta doble eléctrico  
Double electric pasta cooker

MODELO / MODÈLE / MODELO / MODEL CÓDIGO / CODE / CÓDIGO / CODE		UDCP7DAPE 5700.056
<b>Preço / Prix / Precio / Price</b>	€	<b>3.711,00</b>
Dimensões / Dimensions / Dimensiones	mm	800x730x900
Potência total / Puissance total / Potência total / Total power	kW	20
Tensão/Tension Tensión / Tension	V	400
Capacidade cuba / Capacité cuve / Capacidad cuba / Tank capacity	L	22+22
Dimensão cuba / Dimensiones cuve / Dimensiones cuba / Tank dimensions	mm	2 x 300x365x260
Dimensões cestos / Dim. paniers / Dim. cestas / Basket dim.	mm	4 x 120x160x200 2 x 220x170x200
Peso Líquido-Bruto / Poids Net-Brut / Peso Neto-Bruto / Net-Gross Weight	Kg	75

\* Com armário+porta | Avec armoire+porte | Con armario+puerta | With cupboard+door

eléctrico  
électrique  
eléctrico  
electricgás  
gaz  
gas  
gas

OPCIONAIS CookHIT 700 / OPTIONNELLES CookHIT 700 / OPCIONALES CookHIT 700 / CookHIT 700 OPTIONALS 204&gt;207

Consulte condições na pág. 6 • Voir conditions dans la page 6 • Ver condiciones en la pág. 6 • Conditions on page 6

185

**Containers não incluídos**

 Containers pas inclus  
 Containers no incluido  
 Containers not included

**Ver página de acessórios**

 Voir page d'accessoires  
 Ver página de accesorios  
 See accessories page

**GN 1/1**

**UDBM7DAPE**
**Banho-maria simples elétrico com armário+porta**

 Bain-marie simple électrique avec armoire+porte  
 Baño maría simples eléctrico con armario+puerta  
 Single electric bain-marie with cupboard+door

MODELO / MODÈLE / MODELO / MODEL	UDBM7SAPE	
CÓDIGO / CODE / CÓDIGO / CODE	5700.054	
<b>Preço / Prix / Precio / Price</b>	<b>€</b>	<b>1.548,00</b>
Dimensões / Dimensions / Dimensiones	mm	400x730x900
Potência total / Puissance total / Potência total / Total power	kW	1,5
Tensão / Tension / Tensión / Tension	V	230
Secções cabo / Sections câbles / Secciones de cable / Cable sections		3x4 mm <sup>2</sup> H05RNF
Capacidade cuba / Capacité cuve / Capacidad cuba / Tank capacity	L	21
Dimensão cuba / Dimensiones cuve / Dimensiones cuba / Tank dimensions	mm	1 x GN 1/3x150 - 1 x GN2/3x150
Volume / Volume / Volume / Volume	m <sup>3</sup>	0,38
Peso Líquido-Bruto / Poids Net-Brut / Peso Neto-Bruto / Net-Gross Weight	Kg	36

**Banho-maria duplo elétrico com armário+porta**

 Bain-marie double électrique avec armoire+porte  
 Baño maría doble eléctrico con armario+puerta  
 Double electric bain-marie with cupboard+door

MODELO / MODÈLE / MODELO / MODEL	UDBM7DAPE	
CÓDIGO / CODE / CÓDIGO / CODE	5700.052	
<b>Preço / Prix / Precio / Price</b>	<b>€</b>	<b>2.002,00</b>
Dimensões / Dimensions / Dimensiones	mm	800x730x900
Potência total / Puissance total / Potência total / Total power	kW	3
Tensão / Tension / Tensión / Tension	V	230
Secções cabo / Sections câbles / Secciones de cable / Cable sections		3x4 mm <sup>2</sup> H 05 R NF
Capacidade cuba / Capacité cuve / Capacidad cuba / Tank capacity	L	42
Dimensão cuba / Dimensiones cuve / Dimensiones cuba / Tank dimensions	mm	1 x GN 1/1x150 - 3 x GN 1/4x150
Volume / Volume / Volume / Volume	m <sup>3</sup>	0,75
Peso Líquido-Bruto / Poids Net-Brut / Peso Neto-Bruto / Net-Gross Weight	Kg	65



UDI

Cook HIT  
700

**ELEMENTOS NEUTROS - COOK HIT 700**

ÉLÉMENT NEUTRE - COOK HIT 700

ELEMENTOS NEUTROS - COOK HIT 700

NEUTRAL UNITS - COOK HIT 700



**Elemento neutro simples com armário+porta**

Élément neutre simple avec armoire+porte

Elemento neutro simples con armario+puerta

Single neutral elemento with cupboard+door

MODELO / MODÈLE / MODELO / MODEL	UDEN7SAP	
CÓDIGO / CODE / CÓDIGO / CODE	5700.078	
<b>Preço / Prix / Precio / Price</b>	€	<b>1.014,00</b>
Dimensões / Dimensions / Dimensiones	mm	400x730x900
Peso Líquido-Bruto / Poids Net-Brut / Peso Neto-Bruto / Net-Gross Weight	Kg	35-40



**Elemento neutro duplo com armário+porta**

Élément neutre double avec armoire+porte

Elemento neutro doble con armario+puerta

Double neutral elemento with cupboard+door

MODELO / MODÈLE / MODELO / MODEL	UDEN7DAP	
CÓDIGO / CODE / CÓDIGO / CODE	5700.080	
<b>Preço / Prix / Precio / Price</b>	€	<b>1.415,00</b>
Dimensões / Dimensions / Dimensiones	mm	800x730x900
Peso Líquido-Bruto / Poids Net-Brut / Peso Neto-Bruto / Net-Gross Weight	Kg	40-50



MODELO / MODÈLE / MODELO / MODEL	UDFB760E	
CÓDIGO / CODE / CÓDIGO / CODE	5700.064	
<b>Preço / Prix / Precio / Price</b>	<b>€</b>	<b>4.513,00</b>
Dimensões / Dimensions / Dimensiones	mm	800x730x900
Potência / Puissance Potência / Power	Qn/kW	9
Tensão / Tension / Tension / Tension	V	400
Capacidade cuba / Capacité cuve / Capacidad cuba / Tank capacity	L	60
Dimensão cuba / Dimensiones cuve / Dimensiones cuba / Tank dimensions	mm	695x450x200
Peso Líquido-Bruto / Poids Net-Brut / Peso Neto-Bruto / Net-Gross Weight	Kg	110/130



MODELO / MODÈLE / MODELO / MODEL	UDFB760G	
CÓDIGO / CODE / CÓDIGO / CODE	5700.066	
<b>Preço / Prix / Precio / Price</b>	<b>€</b>	<b>5.394,00</b>
Dimensões / Dimensions / Dimensiones	mm	800x730x900
Potência / Puissance Potência / Power	Qn/kW	18
Tensão / Tension / Tension / Tension	V	230
Capacidade cuba / Capacité cuve / Capacidad cuba / Tank capacity	L	60
Dimensão cuba / Dimensiones cuve / Dimensiones cuba / Tank dimensions	mm	695x450x200
Peso Líquido-Bruto / Poids Net-Brut / Peso Neto-Bruto / Net-Gross Weight	Kg	110/130



UDI



sob pedido  
sur demande  
bajo pedido  
on request

**MARMITAS - COOK HIT 700**

MARMITES - COOK HIT 700

MARMITAS - COOK HIT 700

BOILING PANS - COOK HIT 700



**AQUECIMENTO COM ÓLEO TÉRMICO EM CIRCUITO HERMÉTICO**

CHAUFFAGE A L'HUILE THERMIQUE EN CIRCUIT HERMETIC  
CALEFACCIÓN CON ACEITE TÉRMICO EN CIRCUITO HERMÉTICO  
HEATING WITH THERMAL OIL IN HERMETIC CIRCUIT

**Cuba Aço Inox 304**

Cuba Acero Inox 304  
Cuve Acier Inox 304  
Stainless Steel 304 Vat

**MAIOR  
EFICIÊNCIA**

O óleo térmico mantém a temperatura estabilizada

**FACILIDADE  
UTILIZAÇÃO**

Sem necessidade de reabastecimento diário da dupla câmara.

**INCREASED EFFICIENCY**

Easy to use  
No need for daily restocking of the double chamber.

**EFFICACITÉ ACCRUE**

Facilité d'utilisation  
Pas besoin de réapprovisionnement quotidien de la double chambre.

**MAYOR EFICIENCIA**

Facilidad de uso  
No hay necesidad de reposición diaria de la doble cámara

**NOVO  
NOUVEAU  
NUEVO  
NEW**



**AQUECIMENTO INDIRETO CHAUFFAGE INDIRECT CALENTAMIENTO INDIRECTO INDIRECT HEATING**

MODELO / MODÈLE / MODELO / MODEL		UDM760E
CÓDIGO / CODE / CÓDIGO / CODE		5700.072
<b>Preço / Prix / Precio / Price</b>	<b>€</b>	<b>4.333,00</b>
Dimensões / Dimensions / Dimensiones	mm	800x730x900
Potência / Puissance Potência / Power	kW	6
Tensão / Tension / Tension / Tension	V	400
Capacidade cuba / Capacité cuve / Capacidad cuba / Tank capacity	L	60
Peso Líquido-Bruto / Poids Net-Brut / Peso Neto-Bruto / Net-Gross Weight	Kg	135

**NOVO  
NOUVEAU  
NUEVO  
NEW**



**AQUECIMENTO INDIRETO CHAUFFAGE INDIRECT CALENTAMIENTO INDIRECTO INDIRECT HEATING**

MODELO / MODÈLE / MODELO / MODEL		UDM760E
CÓDIGO / CODE / CÓDIGO / CODE		5700.073
<b>Preço / Prix / Precio / Price</b>	<b>€</b>	<b>6.287,00</b>
Dimensões / Dimensions / Dimensiones	mm	800x730x900
Potência / Puissance Potência / Power	kW	6
Tensão / Tension / Tension / Tension	V	400
Capacidade cuba / Capacité cuve / Capacidad cuba / Tank capacity	L	60
Dimensão cuba / Dimensiones cuve / Dimensiones cuba / Tank dimensions	mm	695x450x200
Peso Líquido-Bruto / Poids Net-Brut / Peso Neto-Bruto / Net-Gross Weight	Kg	105



elétrico  
électrique  
eléctrico  
electric

OPCIONAIS CookHIT 700 / OPTIONNELLES CookHIT 700 / OPCIONALES CookHIT 700 / CookHIT 700 OPTIONALS 204>207

Consulte condições na pág. 6 • Voir conditions dans la page 6 • Ver condiciones en la pág. 6 • Conditions on page 6



DESENHOS TÉCNICOS  
DESSINS TECHNIQUES  
DIBUJOS TÉCNICOS  
TECHNICAL DRAWINGS

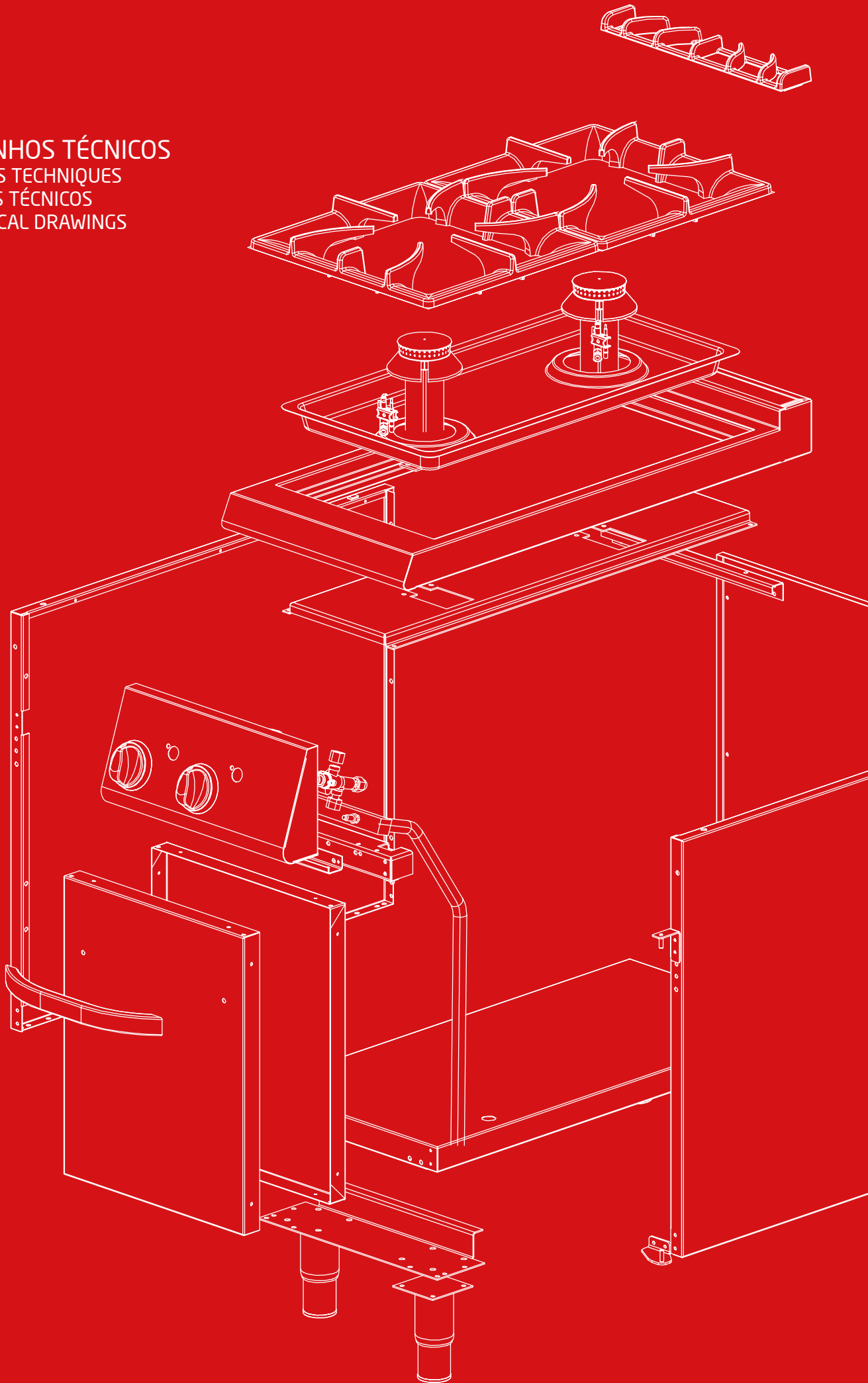



FOGÕES A GÁS  
CUISINIÈRES A GAZ  
COCINAS A GAS  
GAS RANGE  
**UDF072APG**  
5700.002

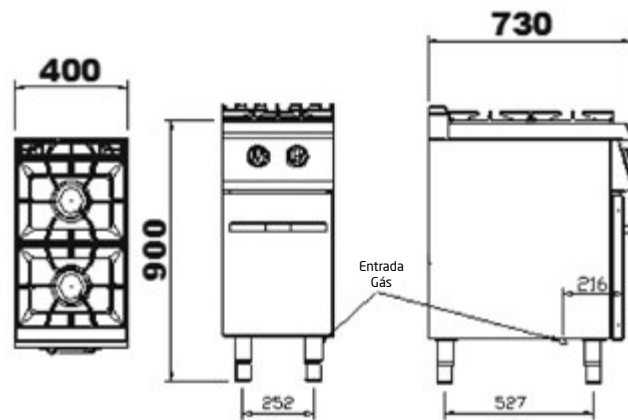

FOGÕES A GÁS  
CUISINIÈRES A GAZ  
COCINAS A GAS  
GAS RANGE  
**UDFC7SAPG**  
5700.015

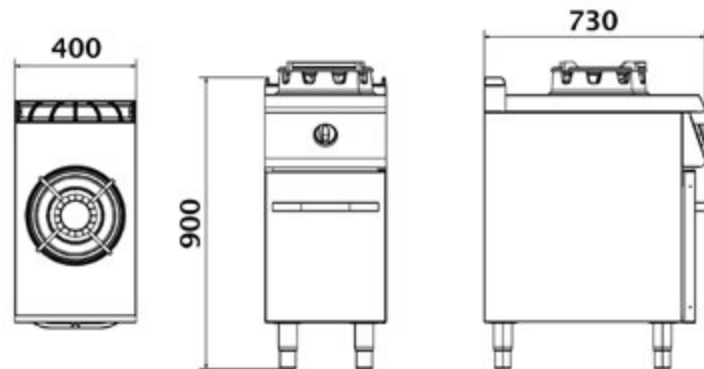

FOGÕES A GÁS  
CUISINIÈRES A GAZ  
COCINAS A GAS  
GAS RANGE  
**UDF074APG**  
5700.004

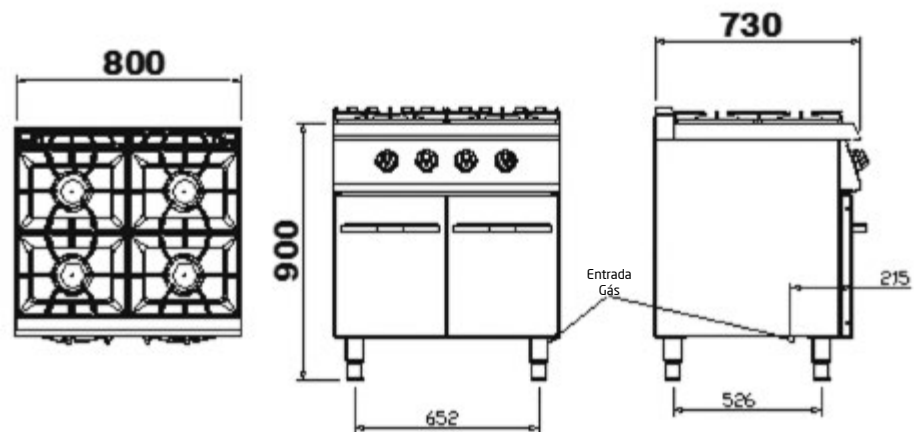





UDI

Cook HIT  
700

**COOK HIT 700 - DESENHOS TÉCNICOS**

COOK HIT 700 - DESSINS TECHNIQUES

COOK HIT 700 - DIBUJOS TÉCNICOS

COOK HIT 700 - TECHNICAL DRAWINGS



FOGÕES A GÁS  
CUISINIÈRES A GAZ  
COCINAS A GAS  
GAS RANGE

**UDF076FMG**

5700.006



FOGÕES A GÁS  
CUISINIÈRES A GAZ  
COCINAS A GAS  
GAS RANGE

**UDF074FG**

5700.008

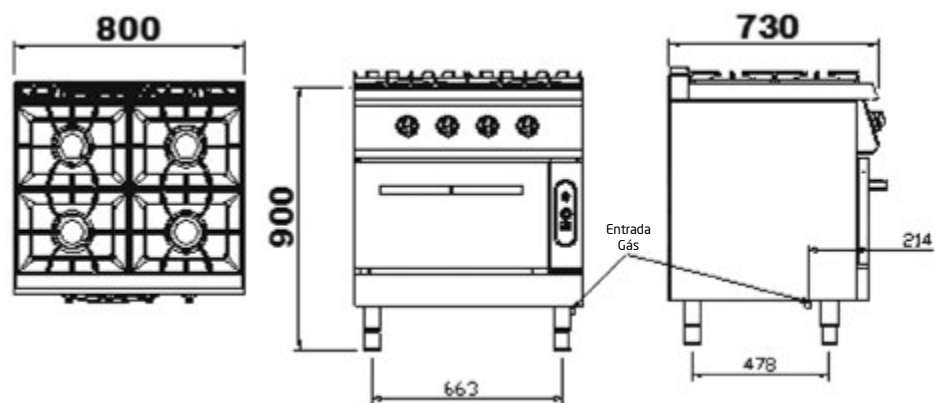

FOGÕES A GÁS  
CUISINIÈRES A GAZ  
COCINAS A GAS  
GAS RANGE

**UDF076APG**

5700.010

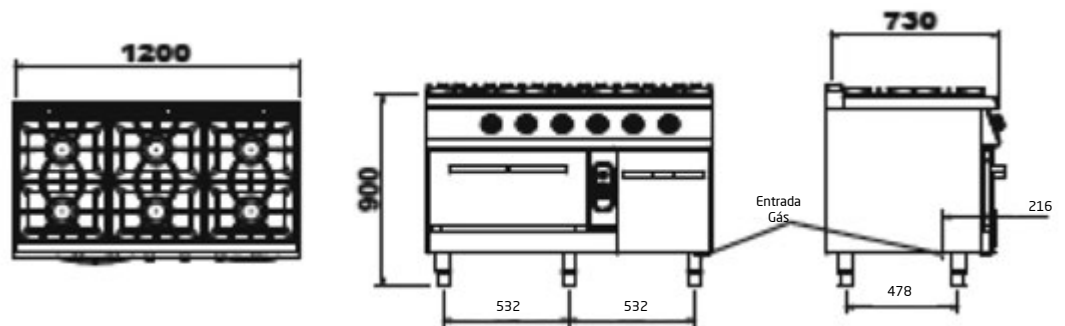

FOGÕES ELÉTRICOS  
CUISINIÈRES ELECTRIQUES  
COCINAS ELÉCTRICAS  
ELECTRIC RANGE

**UDF072APER**

5700.012

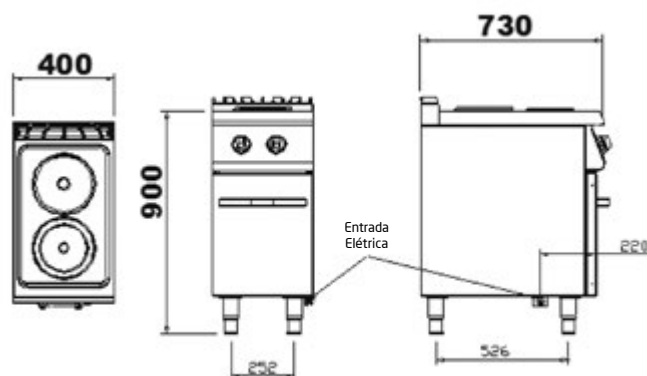



FOGÕES ELÉTRICOS  
CUISINIÈRES ELECTRIQUES  
COCINAS ELÉCTRICAS  
ELECTRIC RANGE

**UDF074APER**

5700.014

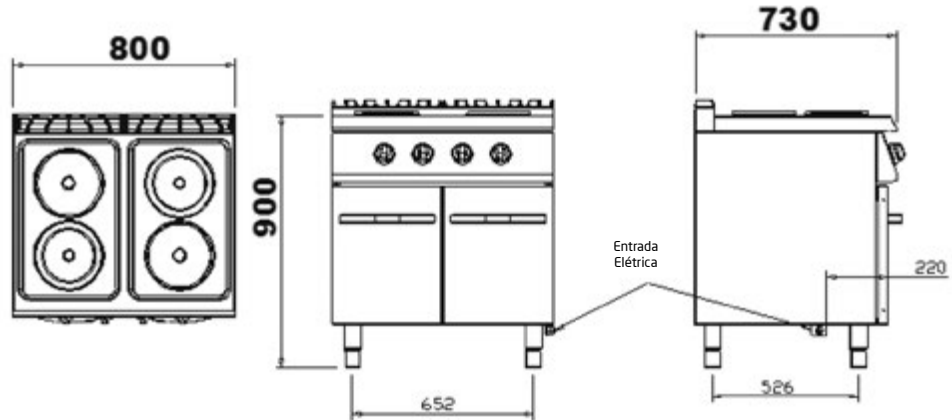

FOGÕES ELÉTRICOS  
CUISINIÈRES ELECTRIQUES  
COCINAS ELÉCTRICAS  
ELECTRIC RANGE

**UDF074FE**

5700.016

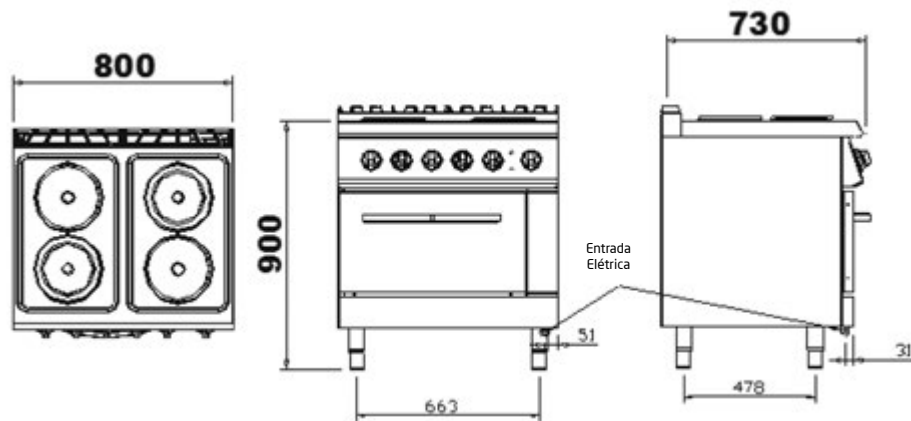

PLACAS ARDENTES A GÁS  
CUISINIÈRES TOUT FOYER GAZ  
PLACAS DE COCINA A GAS  
GAS HOT PLATES

**UDPA7APG**

5700.018

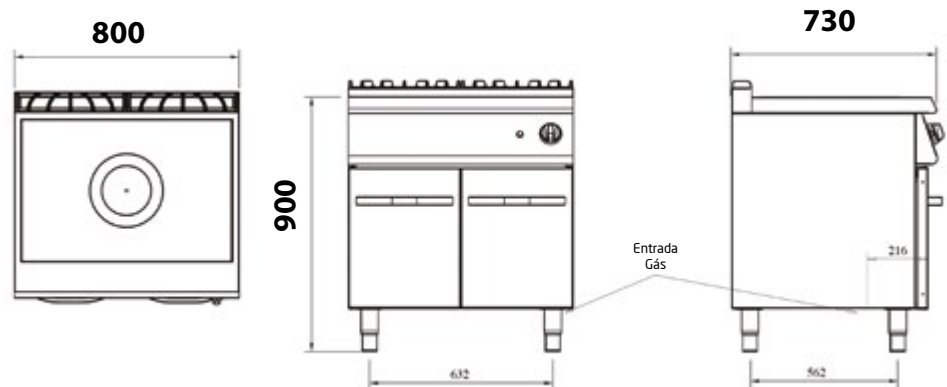

PLACAS ARDENTES A GÁS  
CUISINIÈRES TOUT FOYER GAZ  
PLACAS DE COCINA A GAS  
GAS HOT PLATES

**UDPA7FG**

5700.020

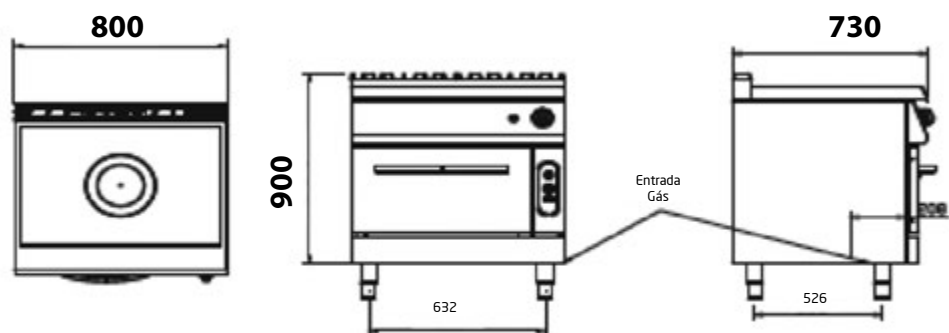



UDI

Cook HIT  
700

**COOK HIT 700 - DESENHOS TÉCNICOS**

COOK HIT 700 - DESSINS TECHNIQUES

COOK HIT 700 - DIBUJOS TÉCNICOS

COOK HIT 700 - TECHNICAL DRAWINGS



FRY-TOPS A GÁS  
GAS FRY-TOP  
FRY-TOPS A GAS  
GAS FRY-TOP  
**UDFT7SLAPG**  
5700.022

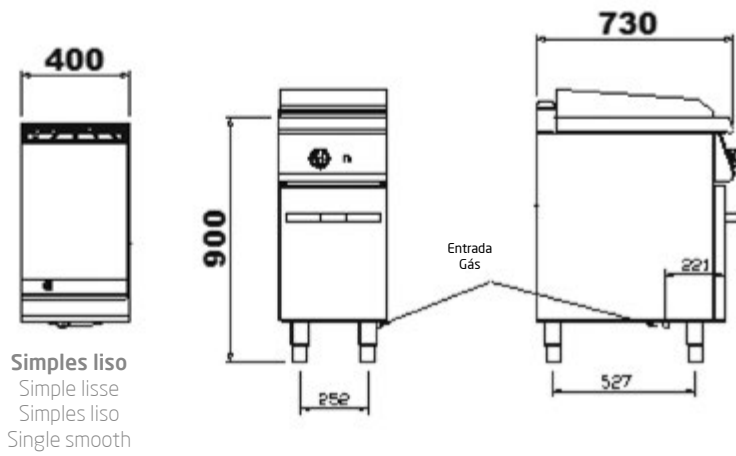

**Simples liso**  
Simple lisse  
Simples liso  
Single smooth

FRY-TOPS A GÁS  
GAS FRY-TOP  
FRY-TOPS A GAS  
GAS FRY-TOP  
**UDFT7SNAPG**  
5700.026

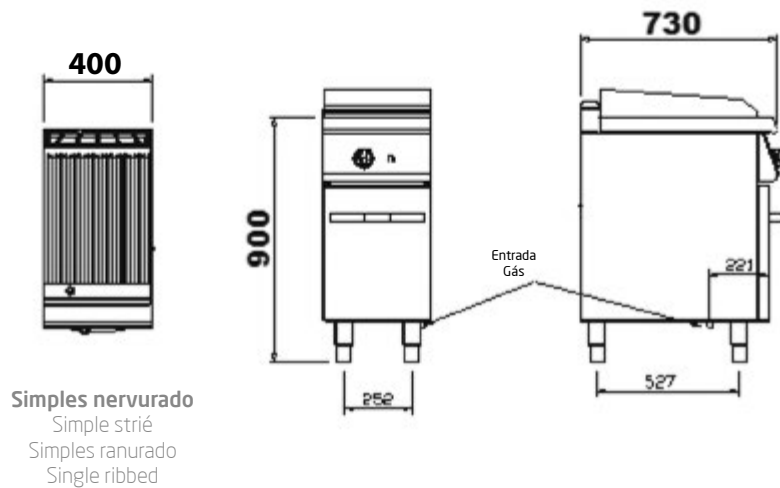

**Simples nervurado**  
Simple strié  
Simples ranurado  
Single ribbed

FRY-TOPS A GÁS  
GAS FRY-TOP  
FRY-TOPS A GAS  
GAS FRY-TOP  
**UDFT7DLAPG**  
5700.030

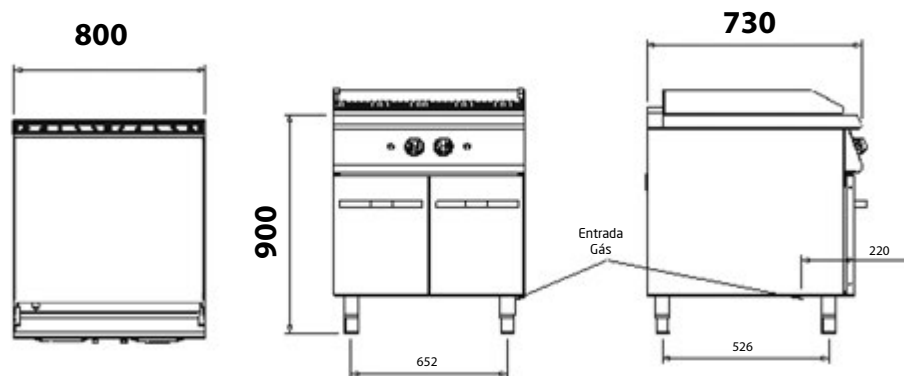

**Duplo liso**  
Double lisse  
Doble liso  
Double smooth



FRY-TOPS A GÁS  
GAS FRY-TOP  
FRY-TOPS A GAS  
GAS FRY-TOP  
**UDFT7DNAPG**  
5700.034

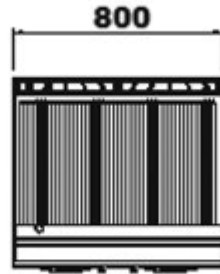

**Duplo nervurado**  
Double strié  
Doble ranurado  
Double ribbed

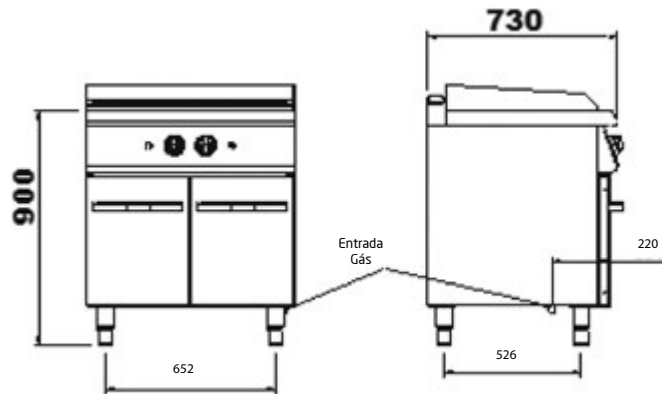

FRY-TOPS A GÁS  
GAS FRY-TOP  
FRY-TOPS A GAS  
GAS FRY-TOP  
**UDFT7DMAPG**  
5700.038



**Duplo misto**  
Double mixte  
Doble mixto  
Double combi

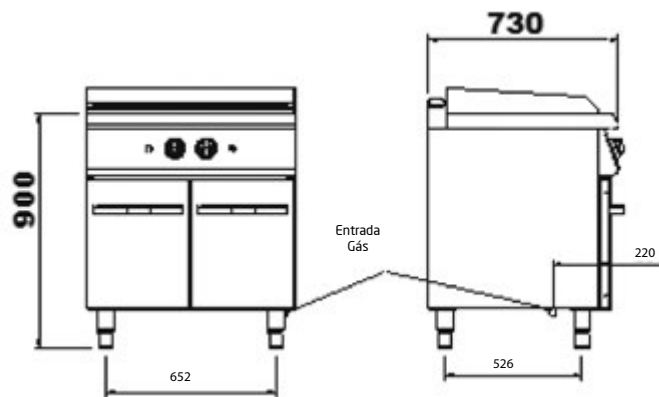

FRY-TOPS ELÉTRICOS  
GRIDDLES ELECTRIQUES  
FRY-TOPS ELÉTRICOS  
ELECTRIC FRY-TOP  
**UDFT7SLAPE**  
5700.024



**Simples liso**  
Simple lisse  
Simples liso  
Single smooth

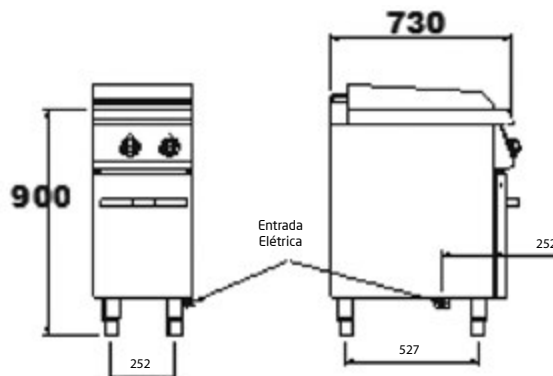



UDI

Cook HIT  
700

**COOK HIT 700 - DESENHOS TÉCNICOS**

COOK HIT 700 - DESSINS TECHNIQUES

COOK HIT 700 - DIBUJOS TÉCNICOS

COOK HIT 700 - TECHNICAL DRAWINGS



FRY-TOPS ELÉTRICOS  
GRIDDLES ÉLECTRIQUES  
FRY-TOPS ELÉCTRICOS  
ELECTRIC FRY-TOP

**UDFT7SNAPE**

5700.028



**Simple nervurado**

Simple strié  
Simple ranurado  
Single ribbed

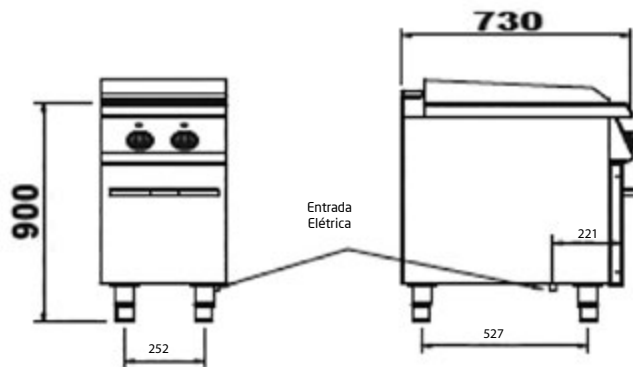

FRY-TOPS ELÉTRICOS  
GRIDDLES ÉLECTRIQUES  
FRY-TOPS ELÉCTRICOS  
ELECTRIC FRY-TOP

**UDFT7DLAPE**

5700.032

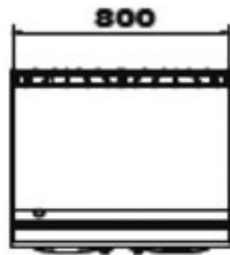

**Duplo liso**

Double lisse  
Doble liso  
Double smooth

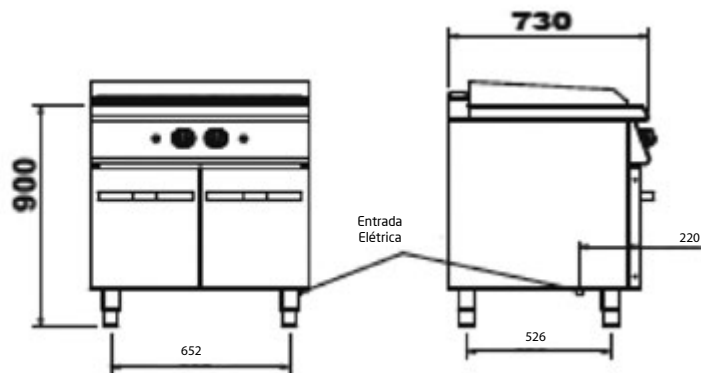

FRY-TOPS ELÉTRICOS  
GRIDDLES ÉLECTRIQUES  
FRY-TOPS ELÉCTRICOS  
ELECTRIC FRY-TOP

**UDFT7DNAPE**

5700.036



**Duplo nervurado**

Double strié  
Doble ranurado  
Double ribbed

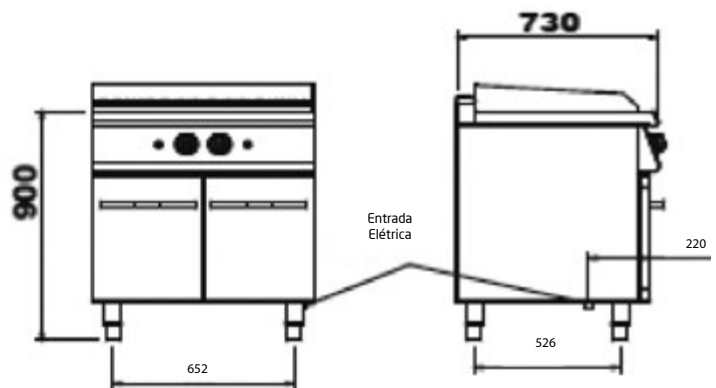



FRY-TOPS ELÉTRICOS  
GRIDDLES ELÉCTRIQUES  
FRY-TOPS ELÉCTRICOS  
ELECTRIC FRY-TOP

**UDFT7DMAPE**

5700.040

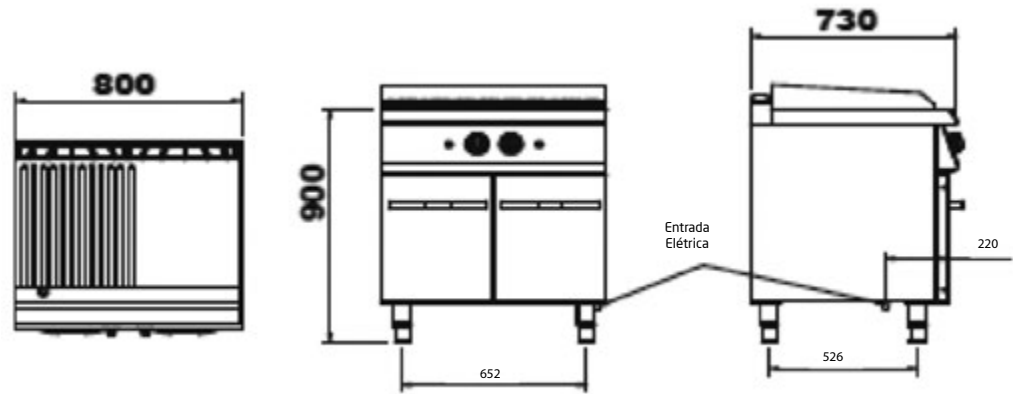

Duplo misto  
Double mixte  
Doble mixto  
Double combi

FRITADEIRAS ELÉTRICAS  
FRITEUSES ELECTRIQUES  
FREIDORAS ELÉCTRICAS  
ELECTRIC FRYERS

**UDFR718APE**

5700.042

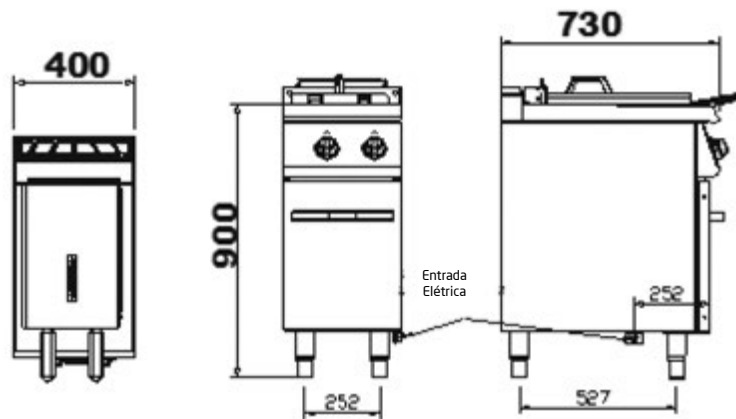

FRITADEIRAS ELÉTRICAS  
FRITEUSES ELECTRIQUES  
FREIDORAS ELÉCTRICAS  
ELECTRIC FRYERS

**UDFR718DAPE**

5700.046

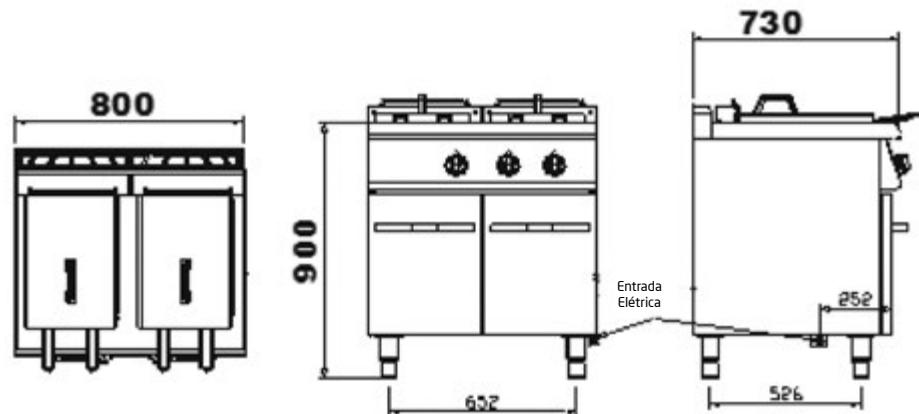



UDI

Cook HIT  
700

**COOK HIT 700 - DESENHOS TÉCNICOS**

COOK HIT 700 - DESSINS TECHNIQUES

COOK HIT 700 - DIBUJOS TÉCNICOS

COOK HIT 700 - TECHNICAL DRAWINGS



FRITADEIRAS GÁS  
FRITEUSES GAS  
FREIDORAS GAS  
GAS FRYERS  
**UDFR718APG**  
5700.044

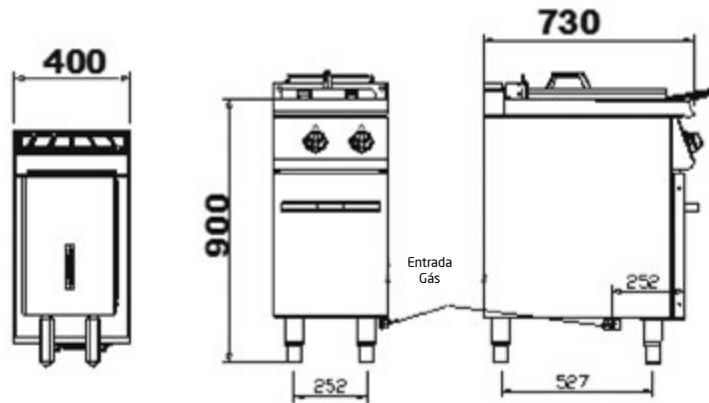

FRITADEIRAS GÁS  
FRITEUSES GAS  
FREIDORAS GAS  
GAS FRYERS  
**UDFR 718DAPG**  
5700.048

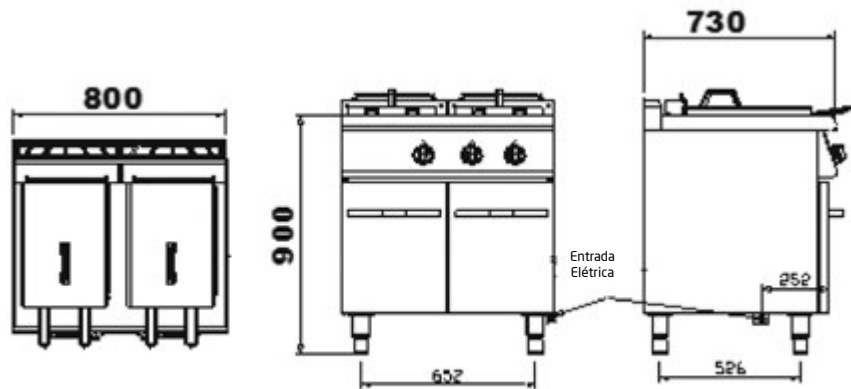

AQUECEDOR DE BATATA FRITA  
CHAUFFE POMME DE TERRE  
CALENTADOR DE PATATA FRITA  
FRYED CHIP WARMER  
**UDABF7APE**  
5700.050

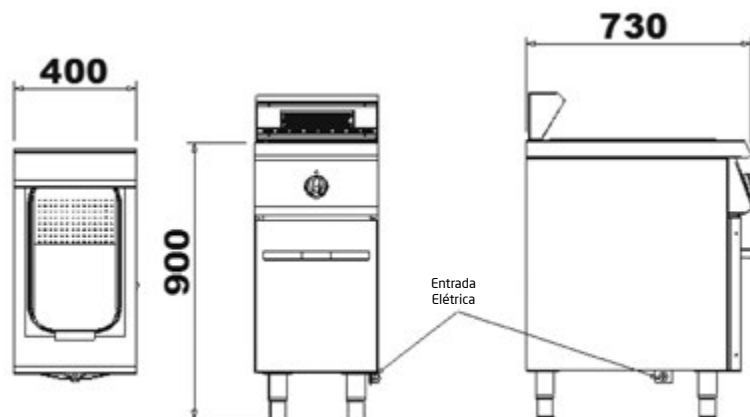



BANHOS-MARIA  
BAIN-MARIE  
BAÑOS MARÍA  
BAIN-MARIES

**UDBM7SAPE**

5700.054

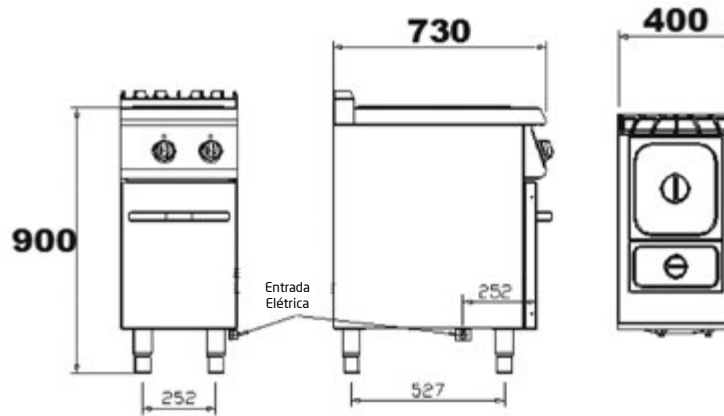

COZEDORES DE PASTA  
CUISEURS A PATES  
COCEDORES DE PASTA  
PASTA COOKERS

**UDCP7DAPE**

5700.056

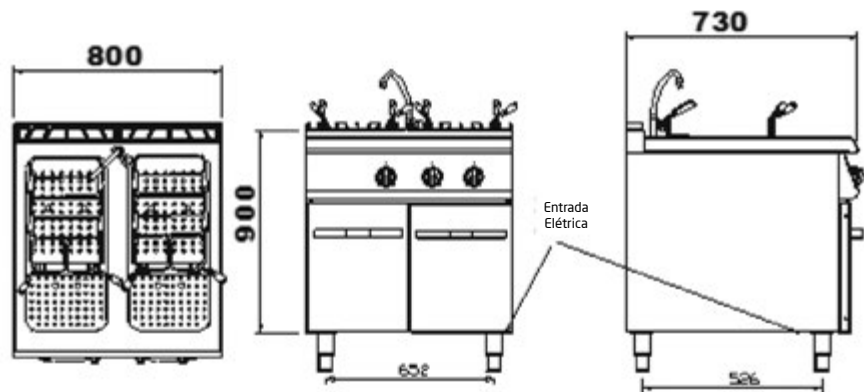

COZEDORES DE PASTA  
CUISEURS A PATES  
COCEDORES DE PASTA  
PASTA COOKERS

**UDCP7SAPG**

5700.057

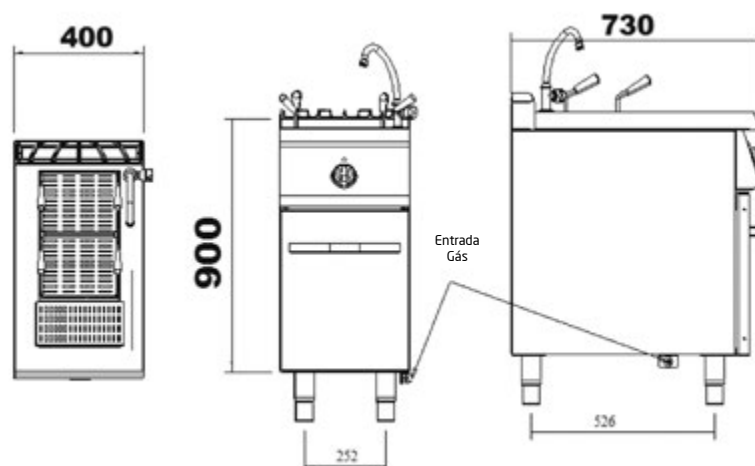





UDI

Cook HIT  
700

**COOK HIT 700 - DESENHOS TÉCNICOS**

COOK HIT 700 - DESSINS TECHNIQUES

COOK HIT 700 - DIBUJOS TÉCNICOS

COOK HIT 700 - TECHNICAL DRAWINGS



COZEDORES DE PASTA  
CUISEURS A PATES  
COCEDORES DE PASTA  
PASTA COOKERS  
**UDCP7SAPE**  
5700.058

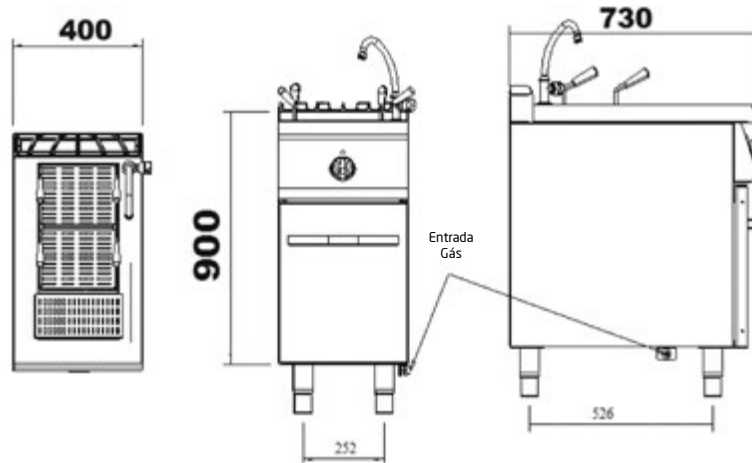

COZEDORES DE PASTA  
CUISEURS A PATES  
COCEDORES DE PASTA  
PASTA COOKERS  
**UDBM7DAPE**  
5700.052

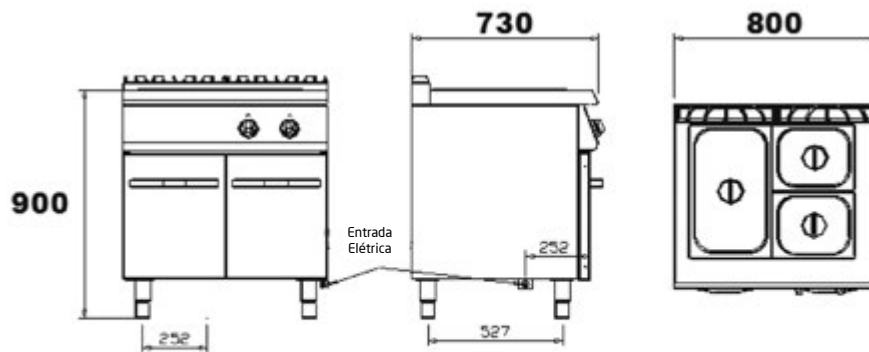

FRITADEIRAS BASCULANTES ELÉTRICAS  
FRITEUSES BASCULANT ÉLECTRIQUE  
FREIDORAS BASCULANTES ELÉCTRICAS  
ELECTRIC TILTING FRYERS  
**UDFB760E**  
5700.064

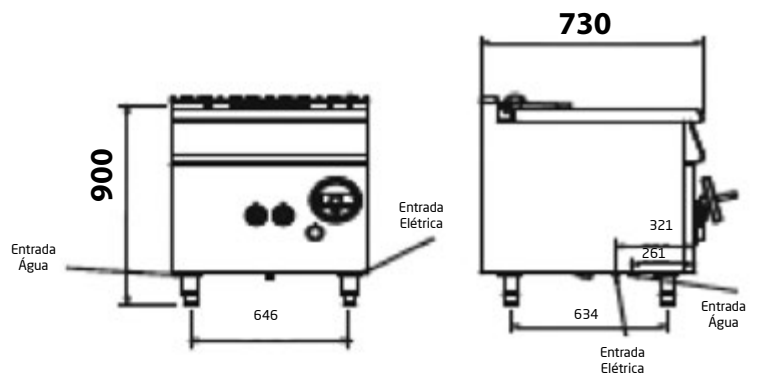



FRITADEIRAS BASCULANTES GÁS  
FRITEUSES BASCULANT GAZ  
FREIDORAS BASCULANTES GAS  
GAS TILTING FRYERS

**UDFB760G**

5700.066

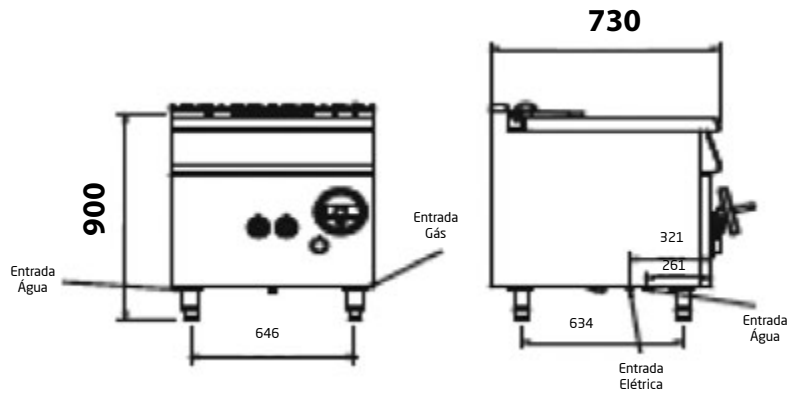
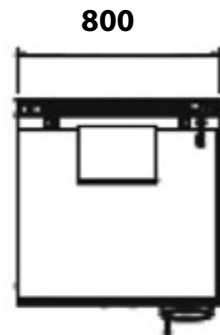

GRELHADORES DE PEDRA LÁVICA A GÁS  
GRILLES A ROCHE LAVIQUE A GAZ  
PARRILAS DE PIEDRA LÁVICA A GAS  
GAS GRILLS AND LAVA STONE

**UDGPL7SAPG**

5700.068

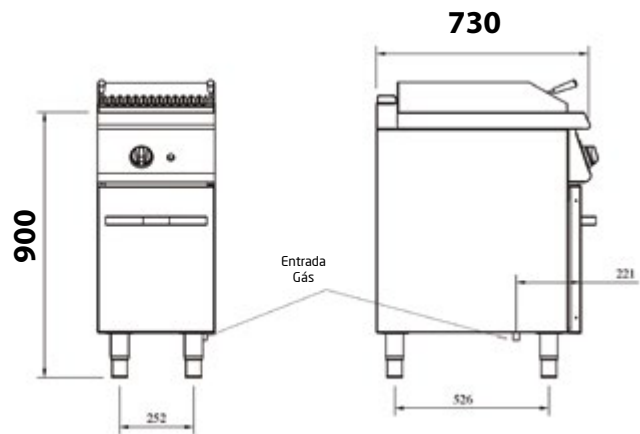

GRELHADORES DE PEDRA LÁVICA A GÁS  
GRILLES A ROCHE LAVIQUE A GAZ  
PARRILAS DE PIEDRA LÁVICA A GAS  
GAS GRILLS AND LAVA STONE

**UDGPL7DAPG**

5700.070

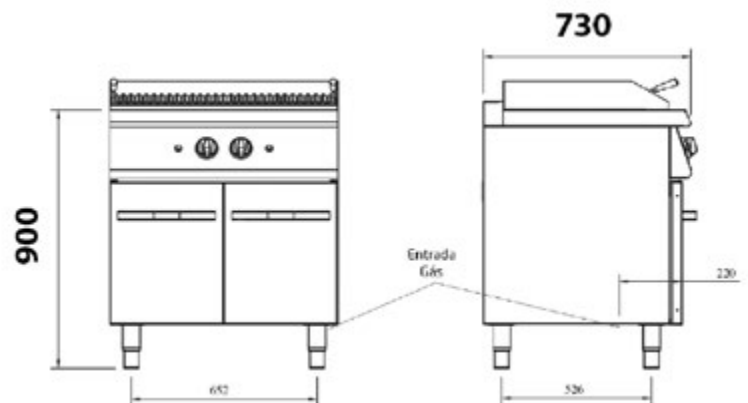
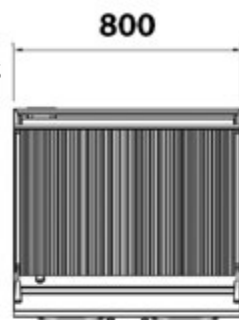



## ACESSÓRIOS E OPCIONAIS

ACCESSOIRES ET OPTIONNELS

ACCESORIOS Y OPCIONALES

OPTIONALS AND SPARE PARTS

**Modelo / Modèle / Modelo / Model**  
**TABULEIRO P/ FORNO UDI**

 PLATEAU P/FOUR UDI  
 BANDEJA P/HORNO UDI  
 TRAY F/OVEN UDI

Código / Code / Código / Code

**5700.090**
**158,00€**

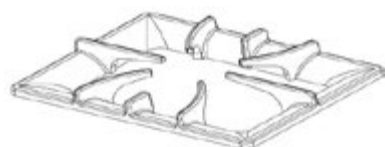
 Dimensões / Dimensions / Dimensiones  
**GN2/1 - 530X650X65**

**Modelo / Modèle / Modelo / Model**  
**GRELHA P/ FOGÃO**

 GRILLES P/CUISINIÈRES  
 REJILLAS P/COCINAS  
 GRILLS F/GAS RANGE

Código / Code / Código / Code

**5700.092**
**81,00€**

 Dimensões / Dimensions / Dimensiones  
**290X395**

**Modelo / Modèle / Modelo / Model**  
**CHAMINÉ P/ EXTRAÇÃO DE FUMO**

 CHEMINÉE P/ EXTRACTION FUMÉE  
 CHIMENEA P/ EXTRACCIÓN DE HUMO  
 FLUE F/ SMOKE EXTRACTION

Código / Code / Código / Code

**5700.094**
**32,00€**

 Dimensões / Dimensions / Dimensiones  
**400X70**

**Modelo / Modèle / Modelo / Model**  
**TABULEIRO P/ MAXIFORNO**

 PLATEAU P/MAXIFORNO  
 BANDEJA P/MAXIFORNO  
 TRAY F/MAXIFORNO

Código / Code / Código / Code

**5700.096**
**106,00€**

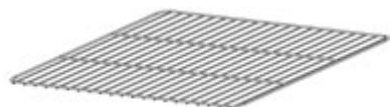
 Dimensões / Dimensions / Dimensiones  
**935X640**

**Modelo / Modèle / Modelo / Model**  
**GRELHA P/ MAXIFORNO**

 GRILLES P/MAXIFORNO  
 REJILLAS P/MAXIFORNO  
 GRILLS F/MAXIFORNO

Código / Code / Código / Code

**5700.098**
**114,00€**

 Dimensões / Dimensions / Dimensiones  
**935X590**

**Modelo / Modèle / Modelo / Model**  
**GRELHA P/ FORNO GN2/1**

 GRILLES P/FOUR  
 REJILLAS P/HORNO  
 GRILLS F/OVEN UDI

Código / Code / Código / Code

**5700.100 / 5900.110**
**57,00€**

 Dimensões / Dimensions / Dimensiones  
**535 X590**



UDI

Cook HIT  
700

**ACESSÓRIOS E OPCIONAIS - COOK HIT 700**

ACCESSOIRES ET OPTIONNELS - COOK HIT 700

ACCESORIOS Y OPCIONALES - COOK HIT 700

OPCIONALS AND SPARE PARTS - COOK HIT 700

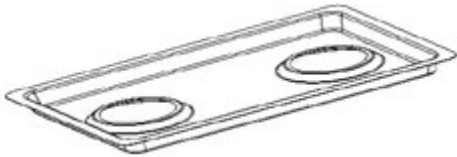

Modelo / Modèle / Modelo / Model  
**TABULEIRO DE RECOLHA DE RESÍDUOS**

PLATEAU  
BANDEJA  
TRAY

Dimensões / Dimensions / Dimensiones  
**524X338X30**

Código / Code / Código / Code  
**5700.102**  
**298,00€**



Modelo / Modèle / Modelo / Model  
**CESTO P/ FRITADEIRA 18LTS ELECTRICA**

PANIER P/ FRITEUSES 18LTS ELECTRIQUES  
CESTAP/ FREIDORAS 18LTS ELÉCTRICAS  
BASKET F/ FRYERS 18LTS ELECTRIC

Dimensões / Dimensions / Dimensiones  
**140x235x185**

Código / Code / Código / Code  
**5700.107**  
**150,00€**



Modelo / Modèle / Modelo / Model  
**CESTO P/ FRITADEIRA 18LTS GÁS**

PANIER P/ FRITEUSES 18LTS GAZ  
CESTAP/ FREIDORAS 18LTS GAS  
BASKET F/ FRYERS 18LTS GAS

Dimensões / Dimensions / Dimensiones  
**260x280x130**  
Dimensões / Dimensions / Dimensiones  
**280x280x130**

Código / Code / Código / Code  
**5700.104**  
**96,00€**  
**5700.109**  
**96,00€**



Modelo / Modèle / Modelo / Model  
**CESTO P/ FRITADEIRA 18LTS GÁS**

PANIER P/ FRITEUSES 18LTS GAZ  
CESTAP/ FREIDORAS 18LTS GAS  
BASKET F/ FRYERS 18LTS GAS

Dimensões / Dimensions / Dimensiones  
**140x280x130**

Código / Code / Código / Code  
**5700.105**  
**86,00€**



Modelo / Modèle / Modelo / Model  
**CESTO P/ COZE PASTA SIMPLES ELECTRICO**

PANIER P/ CUISEURS A PATES SIMPLE ELECTRIQUES  
CESTAP/ COCEDORES DE PASTA SIMPLES ELÉCTRICAS  
BASKET F/ PASTA COOKERS SINGLE ELECTRIC

Dimensões / Dimensions / Dimensiones  
**270x145x180**

Código / Code / Código / Code  
**5700.106**  
**107,00€**



Modelo / Modèle / Modelo / Model  
**CESTO PEQUENO P/ COZE PASTA SIMPLES ELE**

PANIER P/ CUISEURS A PATES SIMPLE ELECTRIQUES  
CESTAP/ COCEDORES DE PASTA SIMPLES ELÉCTRICAS  
BASKET F/ PASTA COOKERS SINGLE ELECTRIC

Dimensões / Dimensions / Dimensiones  
**135x180x180**

Código / Code / Código / Code  
**5700.108**  
**85,00€**



Modelo / Modèle / Modelo / Model  
**CESTO P/ COZE PASTA SIMPLES GAS**  
 PANIER P/ CUISEURS A PATES SIMPLE GAZ  
 CESTAP/ COCEDORES DE PASTA SIMPLES GAS  
 BASKET F/ PASTA COOKERS SINGLE GAS

Dimensões / Dimensions / Dimensiones  
**237x190x255**

Código / Code / Código / Code  
**5900.122**  
**150,00€**



Modelo / Modèle / Modelo / Model  
**CESTO PEQUENO P/ COZE PASTA SIMPLES GAS**  
 PANIER P/ CUISEURS A PATES SIMPLE GAZ  
 CESTAP/ COCEDORES DE PASTA SIMPLES GAS  
 BASKET F/ PASTA COOKERS SINGLE GAS

Dimensões / Dimensions / Dimensiones  
**115x190x255**

Código / Code / Código / Code  
**5700.112**  
**135,00€**



Modelo / Modèle / Modelo / Model  
**TRAVESSÃO P/ BANHO MARIA**  
 TRAVERSE BAIN-MARIE  
 TRAVESSA BAÑOS MARÍA  
 CROSSMEMBER BAIN-MARIES

Dimensões / Dimensions / Dimensiones  
**529X24X11**

Código / Code / Código / Code  
**5700.116**  
**29,00€**



Modelo / Modèle / Modelo / Model  
**TRAVESSÃO P/ BANHO MARIA**  
 TRAVERSE BAIN-MARIE  
 TRAVESSA BAÑOS MARÍA  
 CROSSMEMBER BAIN-MARIES

Dimensões / Dimensions / Dimensiones  
**264X48X11**

Código / Code / Código / Code  
**5700.118**  
**29,00€**

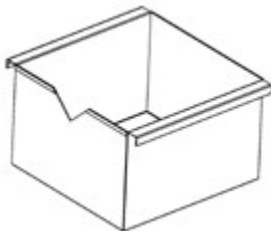

Modelo / Modèle / Modelo / Model  
**CUBA DE RECUPERADOR DE ÓLEO**  
 BAC RÉCUPÉRATION HUILE  
 CUBA DE RECUPERADOR DEACEITE  
 OIL DRAIN-OFF PAN

Dimensões / Dimensions / Dimensiones  
**250X520X200**

Código / Code / Código / Code  
**5700.120**  
**143,00€**



Modelo / Modèle / Modelo / Model  
**RASPADOR**  
 RACLETTE  
 RASPADOR  
 SCRAPER

Código / Code / Código / Code  
**5700.122**  
**120,00€**



UDI

Cook HIT  
700

**ACESSÓRIOS E OPCIONAIS - COOK HIT 700**

ACCESSOIRES ET OPTIONNELS - COOK HIT 700

ACCESORIOS Y OPCIONALES - COOK HIT 700

OPCIONALS AND SPARE PARTS - COOK HIT 700



Modelo / Modèle / Modelo / Model  
**TAMPA EM AÇO INOX**

COUVERCLE EN ACIER INOX  
TAPA EN ACERO  
STAINLESS STEEL COVER

Dimensões / Dimensions / Dimensiones  
**1/1 GN - 325x530**

Código / Code / Código / Code  
**5900.830**  
**26,00€**

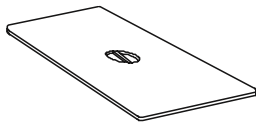

Modelo / Modèle / Modelo / Model  
**TAMPA EM AÇO INOX**

COUVERCLE EN ACIER INOX  
TAPA EN ACERO  
STAINLESS STEEL COVER

Dimensões / Dimensions / Dimensiones  
**1/2 GN - 325x265**

Código / Code / Código / Code  
**5900.850**  
**17,00€**



Modelo / Modèle / Modelo / Model  
**TAMPA EM AÇO INOX**

COUVERCLE EN ACIER INOX  
TAPA EN ACERO  
STAINLESS STEEL COVER

Dimensões / Dimensions / Dimensiones  
**1/3GN - 325x176**

Código / Code / Código / Code  
**5900.880**  
**13,00€**

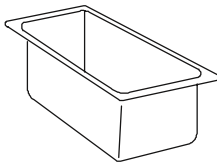

Modelo / Modèle / Modelo / Model  
**CONTAINER EM AÇO INOX**

BAC EN ACIER INOX  
CUBA EN ACERO INOX  
STAINLESS STEEL CONTAINER

Dimensões / Dimensions / Dimensiones  
**1/1 GN 150h - 530x325x150**

Código / Code / Código / Code  
**5900.824**  
**50,00€**

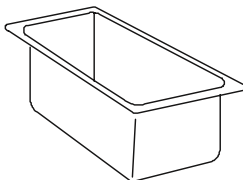

Modelo / Modèle / Modelo / Model  
**CONTAINER EM AÇO INOX**

BAC EN ACIER INOX  
CUBA EN ACERO INOX  
STAINLESS STEEL CONTAINER

Dimensões / Dimensions / Dimensiones  
**1/2 GN 150h - 325x265x150**

Código / Code / Código / Code  
**2050.018**  
**35,00€**

**5900.862**  
**31,00€**

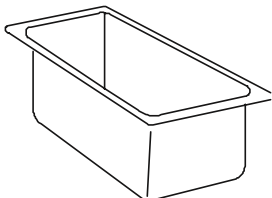

Modelo / Modèle / Modelo / Model  
**CONTAINER EM AÇO INOX**

BAC EN ACIER INOX  
CUBA EN ACERO INOX  
STAINLESS STEEL CONTAINER

Dimensões / Dimensions / Dimensiones  
**1/3 GN 150h - 325x176x150**

Código / Code / Código / Code  
**5900.870**  
**36,00€**

## A NECESSIDADE DO ALTO RENDIMENTO INTERPRETADA PELA UDI®.

Um conceito capaz de valorizar de forma integrada e harmoniosa com a arquitectura do projecto, as exigências de:

**ALTA PERFORMANCE  
DESIGN  
ERGONOMIA  
VERSATILIDADE  
POTÊNCIA  
FIABILIDADE  
SUSTENTABILIDADE**

## LA NÉCESSITÉ POUR LA HAUTE PERFORMANCE INTERPRÉTÉE PAR L'UDI®.

Un concept qui peut améliorer de façon intégrée et harmonieuse avec l'architecture du projet, les exigences de:

**HAUTE PERFORMANCE  
LE DESIGN  
L'ERGONOMIE  
LA POLYVALENCE  
LA PUISSANCE  
LA FIABILITÉ  
LA DURABILITÉ**

## LA NECESIDAD DE UN ALTO RENDIMIENTO INTERPRETADA POR UDI®.

Un concepto con capacidad para valorizar las exigencias de:

**ALTO RENDIMIENTO  
DISEÑO  
ERGONOMÍA  
VERSATILIDAD  
POTENCIA  
FIABILIDAD  
SOSTENIBILIDAD.**

De modo integrado y harmonioso con la arquitectura del proyecto.

## UDI® INTERPRETATION ABOUT HIGH PERFORMANCE NEEDS

A concept capable to enhance the demands of:

**HIGH PERFORMANCE  
DESIGN  
ERGONOMICS  
VERSATILITY  
POWER RELIABILITY  
SUSTAINABILITY**

In an integrated and harmonious way with the project architecture.





**SOLUÇÕES PARA  
RESTAURANTES, HOTEIS E RESORTS  
CATERING E TAKE AWAY  
HOSPITAIS  
ESCOLAS**

SOLUTIONS POUR:  
RESTAURANTS, HÔTELS ET VILLÉGIATURES  
RESTAURATION ET À TAKE-AWAY  
HÔPITAUX  
ÉCOLES

SOLUCIONES PARA:  
RESTAURANTES, HOTELES Y RESORTS  
CATERING Y TAKE AWAY  
HOSPITALES  
ESCUELAS

SOLUTIONS FOR:  
RESTAURANTS, HOTELS AND RESORTS  
CATERING AND TAKE-AWAY  
HOSPITALS  
SCHOOLS



**10kW**

**QUEIMADORES**  
Alto rendimento =  
10kW potência  
queimadores 10kW  
nos fogões a gás com  
maxiforno/forno

**BRÛLEURS**  
Haut rendement =  
Puissance 10kW  
Bruleur de 10kW  
Sur cuisiniere a gaz  
avec maxifour/four

**QUEMADORES**  
Alto rendimiento =  
Potencia 10kW  
quemadores 10 kW  
en cocinas a gas con  
maxihorno/horno

**BURNERS**  
High performance =  
10kW power  
burners 10kW  
on a gas stove with  
maxifour/four



**BOTÃO**  
Concepção  
segundo princípios  
de ergonomia e  
preocupações de  
higienização fácil.

**BOUTON**  
Concevoir selon  
les principes de  
l'ergonomie et des  
préoccupations de  
nettoyage faciles.

**BOTÓN**  
Concepción según  
principios ergonómicos  
y preocupaciones de  
fácil limpieza.

**KNOB**  
Conception by  
ergonomic principles  
and easy cleaning  
concerns.

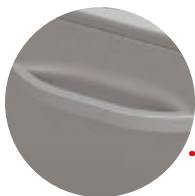

**PUXADOR**  
Design de linhas simples e  
depuradas.  
Concepção segundo  
princípios de ergonomia e  
preocupações de higienização  
fácil.

**POIGNÉE**  
Concevoir des lignes simples  
et propres.  
Conception selon les  
principes de l'ergonomie  
et des préoccupations de  
nettoyage faciles.

**TIRADOR**  
Diseño de líneas simples y  
depuradas.  
Concepción según  
principios ergonómicos y  
preocupaciones de fácil  
limpieza.

**HANDLE**  
Design simple and clean lines.  
Conception by ergonomic  
principles and easy cleaning  
concerns.





UDI



**TABULEIRO DE RECOLHA DE RESIDUOS**  
 Limpeza e manutenção fáceis  
 Queimadores removíveis  
 Recolha de gorduras e outros resíduos em tabuleiro amovível  
 Acesso facilitado ao interior do equipamento

**BAC DE COLLECTE DES DÉCHETS**  
 Nettoyage et l'entretien  
 Brûleurs amovibles  
 Collecteur des graisses et autres déchets dans le bac amovible  
 Accès facile à l'intérieur de la machine

**BANDEJA COLECTORA DE RESIDUOS**  
 Limpieza y mantenimiento fácil  
 Quemadores removibles  
 Colección de grasa y otros residuos en bandeja extraíble  
 Fácil acceso al interior de la máquina

**WASTE DRAIN PAN**  
 Cleaning and easy maintenance  
 Removable burners  
 Collector of grease and other waste in removable tray  
 Easy access to the inside of the machine



Queimadores Cromados (Standard)  
 Brûleurs Chrome (Standard)  
 Quemadores De Cromo (Standard)  
 Chrome Burners (Standard)

Equipamentos preparados de série para Gás Natural  
 Équipements préparés en standard pour le gaz naturel  
 Equipos preparados de serie para Gas Natural  
 Equipment prepared as standard for Natural Gas



**FOGÕES A GÁS**

CUISINIÈRES A GAZ  
COCINAS A GAS  
GAS RANGE

**FOGÕES ELÉTRICOS**

CUISINIÈRES ELECTRIQUES  
COCINAS ELÉCTRICAS  
ELECTRIC RANGE

**PLACAS ARDENTES A GÁS**

CUISINIÈRES TOUT FOYER GAZ  
PLACAS DE COCINA A GAS  
GAS HOT PLATES

**FRY-TOPS A GÁS**

GAS FRY-TOP  
FRY-TOPS A GAS  
GAS FRY-TOP

**FRY-TOPS ELÉTRICOS**

GRIDDLES ELECTRIQUES  
FRY-TOPS ELÉCTRICOS  
ELECTRIC FRY-TOP

**GRELHADORES DE PEDRA LÁVICA A GÁS**

GRILLES ET GRILLES A ROCHE LAVIQUE A GAZ  
PARRILLAS Y PARRILLAS DE PIEDRA LÁVICA  
GAS GRILLS AND LAVA STONE GRILLS

**FRITADEIRAS A GÁS**

FRITEUSES GAS  
FREIDORAS A GAS  
GAS FRYERS

**FRITADEIRAS ELÉTRICAS**

FRITEUSES ELECTRIQUES  
FREIDORAS ELÉCTRICAS  
ELECTRIC FRYERS





UDI

Cook HIT  
900

Cook HIT  
900



### AQUECEDOR DE BATATA FRITA

CHAUFFE POMME DE TERRE  
CALENTADOR DE PATATA FRITA  
FRYED CHIP WARMER

### COZEDORES DE PASTA

CUISEURS A PATES  
COCEDORES DE PASTA  
PASTA COOKERS

### BANHOS-MARIA

BAIN-MARIE  
BAÑOS MARÍA  
BAIN-MARIES

### ELEMENTOS NEUTROS

ÉLÉMENT NEUTRE  
ELEMENTOS NEUTROS  
NEUTRAL UNITS

### MARMITAS

MARMITES  
MARMITAS  
BOILING PANS

### FRITADEIRAS BASCULANTES A GÁS

FRITEUSE BASCULANT GAZ  
FREIDORAS BASCULANTES GAS  
GAS TILTING FRYERS

### FRITADEIRA BASCULANTE ELÉTRICA

FRITEUSE BASCULANT ÉLECTRIQUE  
FREIDORAS BASCULANTES ELÉCTRICAS  
ELECTRIC TILTING FRYERS

### DESENHOS TÉCNICOS

DESSINS TECHNIQUES  
DIBUJOS TÉCNICOS  
TECHNICAL DRAWINGS

### ACESSÓRIOS E OPCIONAIS

ACCESSOIRES ET OPTIONNELS  
ACCESORIOS Y OPCIONALES  
OPCIONALS AND SPARE PARTS

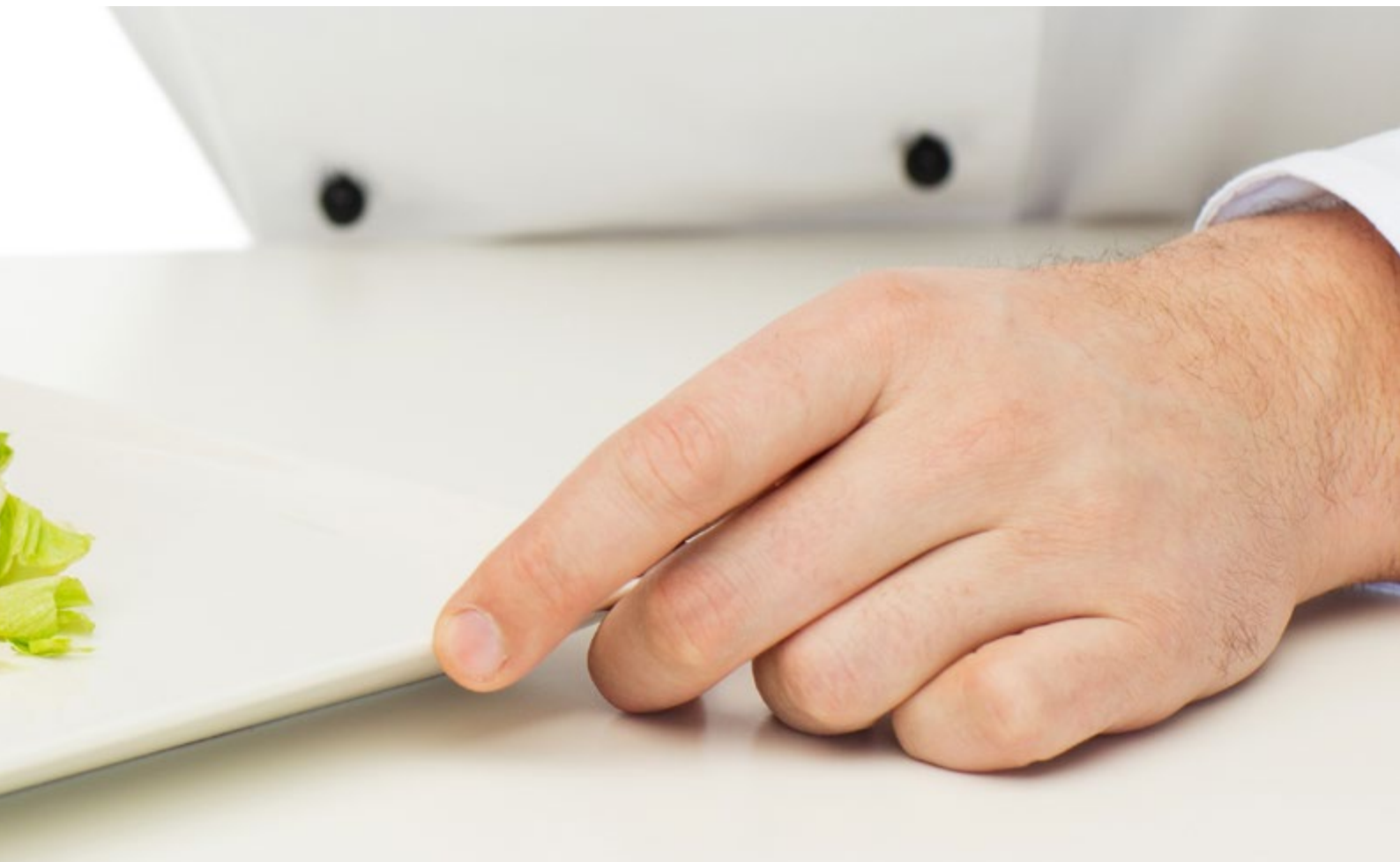



**Fogão a gás 2 queimadores** - Cuisinière a gaz 2 feux - Fogón a gas 2 fuegos - Gas stove 2 burners

MODELO / MODÈLE / MODELO / MODEL CÓDIGO / CODE / CÓDIGO / CODE		UDF092APG 5900.002
<b>Preço / Prix / Precio / Price</b>	€	<b>1.733,00</b>
Dimensões / Dimensions / Dimensiones	mm	400x 900x 900
Potência queimadores /Puissance brûleur /Potência quemadores /Burners Power	kW	2x10
Peso Líquido-Bruto /Poids Net-Brut /Peso Neto-Bruto /Net-Gross Weight	Kg	58-65



**Fogão Wok** - Cuisinière Wok - Fogón Wok - Wok stove

MODELO / MODÈLE / MODELO / MODEL CÓDIGO / CODE / CÓDIGO / CODE		UDFW9APE 5900.015A
<b>Preço / Prix / Precio / Price</b>	€	<b>1.608,00</b>
Dimensões / Dimensions / Dimensiones	mm	400x 900x 900
Potência queimadores /Puissance brûleur /Potência quemadores /Burners Power	kW	15
Peso Líquido-Bruto /Poids Net-Brut /Peso Neto-Bruto /Net-Gross Weight	Kg	85-94



**Fogão a gás 4 queimadores\*** - Cuisinière a gaz 4 feux - Fogón al gas 4 fuegos - Gas stove 4 burners

MODELO / MODÈLE / MODELO / MODEL CÓDIGO / CODE / CÓDIGO / CODE		UDF094APG 5900.004
<b>Preço / Prix / Precio / Price</b>	€	<b>2.764,00</b>
Dimensões / Dimensions / Dimensiones	mm	800x 900x 900
Potência queimadores /Puissance brûleur /Potência quemadores /Burners Power	kW	3x10 + 1x6,5
Peso Líquido-Bruto /Poids Net-Brut /Peso Neto-Bruto /Net-Gross Weight	Kg	97-110



**Fogão a gás 4 queimadores com forno Gás** - Cuisinière a gaz 4 feux avec four gaz - Fogón a gas 4 fuegos con horno gas - Gas stove 4 burners with gas oven

MODELO / MODÈLE / MODELO / MODEL CÓDIGO / CODE / CÓDIGO / CODE		UDF094FG 5900.008
<b>Preço / Prix / Precio / Price</b>	€	<b>3.402,00</b>
Dimensões / Dimensions / Dimensiones	mm	800x 900x 900
Potência queimadores /Puissance brûleur /Potência quemadores /Burners Power	kW	3x10 + 1x6,5
Dim. forno e potência /Dim. four puissance /Dim. horno y potencia /Oven dim. and power	mm	545x645x300 - 1x2/1 GN 6 kW
Peso / Poids / Peso / Weight	Kg	135-145

**NOVO  
NOUVEAU  
NUEVO  
NEW**



**Fogão a gás 4 queimadores com forno elétrico** - Cuisinière a gaz 4 feux avec four électrique - Fogón a gas 4 fuegos con horno eléctrico - Gas stove 4 burners with electric oven

MODELO / MODÈLE / MODELO / MODEL CÓDIGO / CODE / CÓDIGO / CODE		UDF094FE 5900.009
<b>Preço / Prix / Precio / Price</b>	€	<b>4.100,00</b>
Dimensões / Dimensions / Dimensiones	mm	800x 900x 900
Potência queimadores /Puissance brûleur /Potência quemadores /Burners Power	kW	4x8,5
Dim. forno e potência /Dim. four puissance /Dim. horno y potencia /Oven dim. and power	mm	545x645x300 - 1x2/1 GN 6 kW
Peso / Poids / Peso / Weight	Kg	144





UDI

Cook HIT  
900

**FOGÕES GÁS - COOK HIT 900**  
**CUISINIÈRES A GAZ - COOK HIT 900**  
**COCINAS A GAS - COOK HIT 900**  
**GAS RANGE - COOK HIT 900**



**Fogão a gás 6 queimadores + Maxiforno** - Cuisinière a gaz 6 feux + Maxiforno - Fogón a gas 6 fuegos v+ Maxihorno - Gas stove 6 burners + Maxioven



MODELO / MODÈLE / MODELO / MODEL CÓDIGO / CODE / CÓDIGO / CODE	UDF096FMG 5900.006
<b>Preço / Prix / Precio / Price</b>	€ <b>5.170,00</b>
Dimensões / Dimensions / Dimensiones	mm 1200x 900x900
Potência queimadores /Puissance brûleur /Potência quemadores /Burners Power	kW 4x10 + 2x6,5
Peso Líquido-Bruto / Poids Net-Brut/ Peso Neto-Bruto / Net-Gross Weight	Kg 197-212

**Fogão a gás 6 queimadores\*** - Cuisinière a gaz 6 feux - Fogón a gas 6 fuegos - Gas stove 6 burners



MODELO / MODÈLE / MODELO / MODEL CÓDIGO / CODE / CÓDIGO / CODE	UDF096APG 5900.011
<b>Preço / Prix / Precio / Price</b>	€ <b>4.632,00</b>
Dimensões / Dimensions / Dimensiones	mm 1200x 900x 900
Potência queimadores /Puissance brûleur /Potência quemadores /Burners Power	kW 4x10 + 2x6,5
Peso Líquido-Bruto / Poids Net-Brut/ Peso Neto-Bruto / Net-Gross Weight	Kg 122-152

**Fogão a gás 6 queimadores com forno a gás\*** - Cuisinière a gaz 6 feux avec four gaz - Fogón a gas 6 fuegos con horno a gas - Gas stove 6 burners with gas oven



MODELO / MODÈLE / MODELO / MODEL CÓDIGO / CODE / CÓDIGO / CODE	UDF096FG 5900.010
<b>Preço / Prix / Precio / Price</b>	€ <b>5.118,00</b>
Dimensões / Dimensions / Dimensiones	mm 1200x 900x 900
Potência queimadores /Puissance brûleur /Potência quemadores /Burners Power	kW 4x10 + 2x6,5
Dim. forno e potência /Dim. four puissance /Dim. horno y potencia /Oven dim. and power	mm 545x645x300 kW / 1x2/1GN 6 Kw
Peso Líquido-Bruto / Poids Net-Brut/ Peso Neto-Bruto / Net-Gross Weight	Kg 180-210

**Fogão a gás 8 queimadores** - Cuisinière a gaz 8 feux - Fogón a gas 8 fuegos - Gas stove with 8 burners



MODELO / MODÈLE / MODELO / MODEL CÓDIGO / CODE / CÓDIGO / CODE	UDF098APG 5900.015
<b>Preço / Prix / Precio / Price</b>	€ <b>5.899,00</b>
Dimensões / Dimensions / Dimensiones	mm 1600x 900x 900
Potência queimadores /Puissance brûleur /Potência quemadores /Burners Power	kW 6x10 + 2x6,5
Peso Líquido /Poids Net /Peso Neto /Net Weight	Kg 172

**Fogão a gás 8 queimadores com 2 fornos a gás** - Cuisinière a gaz 8 feux avec 2 four gaz - Fogón a gas 8 fuegos con 2 hornos a gas - Gas stove with 8 burners and 2 gas ovens



MODELO / MODÈLE / MODELO / MODEL CÓDIGO / CODE / CÓDIGO / CODE	UDF098FG 5900.014
<b>Preço / Prix / Precio / Price</b>	€ <b>7.849,00</b>
Dimensões / Dimensions / Dimensiones	mm 1600x 900x 900
Potência queimadores /Puissance brûleur /Potência quemadores /Burners Power	kW 6x10 + 2x6,5
Dim. forno e potência /Dim. four puissance /Dim. horno y potencia /Oven dim. and power	mm 2x(545x 645x300) kW 2x2/1GN 2x6kw
Peso Líquido-Bruto / Poids Net-Brut/ Peso Neto-Bruto / Net-Gross Weight	Kg 274-300



**Fogão elétrico de 2 placas quadradas com armário+porta** - Cuisinière électrique de 2 plaques carrées avec armoire+porte - Fogón eléctrico de 2 planchas cuadradas con armário+puerta - 2 square plate electric stove with cupboard+door



MODELO / MODÈLE / MODELO / MODEL CÓDIGO / CODE / CÓDIGO / CODE	UDF092APEQ	
	5900.012	
<b>Preço / Prix / Precio / Price</b>	€	<b>2.241,00</b>
Dimensões / Dimensions / Dimensiones	mm	400x900x900
Potência total / Puissance total / Potência total / Total power	kW	6
Tensão / Tension / Tension / Tension	V	400
Potência placas / Puissance plaques / Potência placas / Plates Power	kW	2x3 kW
Dim. placa de fogão / Dim. plaque de poêle / Dim. placa fogón / Stove plate dim.	mm	2x300x300
Peso Líquido-Bruto / Poids Net-Brut / Peso Neto-Bruto / Net-Gross Weight	Kg	70-85

**Fogão elétrico de 4 placas quadradas com armário+porta** - Cuisinière électrique de 4 plaques carrées avec armoire+porte - Fogón eléctrico de 4 planchas cuadradas con armário+puerta - 4 square plate electric stove with cupboard+door



MODELO / MODÈLE / MODELO / MODEL CÓDIGO / CODE / CÓDIGO / CODE	UDF094APEQ	
	5900.013	
<b>Preço / Prix / Precio / Price</b>	€	<b>3.548,00</b>
Dimensões / Dimensions / Dimensiones	mm	800x900x900
Potência total / Puissance total / Potência total / Total power	kW	12
Tensão / Tension / Tension / Tension	V	400
Potência placas / Puissance plaques / Potência placas / Plates Power	kW	4x3 kW
Dim. placa de fogão / Dim. plaque de poêle / Dim. placa fogón / Stove plate dim.	mm	4x300x300
Peso Líquido-Bruto / Poids Net-Brut / Peso Neto-Bruto / Net-Gross Weight	Kg	115-130

**Fogão elétrico com forno elétrico** - Cuisinière électrique avec four électrique - Fogón eléctrico con - orno eléctrico - Electric stove with electric oven



MODELO / MODÈLE / MODELO / MODEL CÓDIGO / CODE / CÓDIGO / CODE	UDF094AFE0	
	5900.016	
<b>Preço / Prix / Precio / Price</b>	€	<b>4.158,00</b>
Dimensões / Dimensions / Dimensiones	mm	800x900x900
Potência total / Puissance total / Potência total / Total power	kW	18
Tensão / Tension / Tension / Tension	V	400
Potência placas / Puissance plaques / Potência placas / Plates Power	kW	4x3 kW /opcional 4x4
Dim. forno e potência / Dim. four puissance / Dim. horno y potencia / Oven dim. and power	mm- kW	545x645x300 -6 kW
Dim. placa de fogão / Dim. plaque de poêle / Dim. placa fogón / Stove plate dim.	mm	4x300x300
Peso Líquido-Bruto / Poids Net-Brut / Peso Neto-Bruto / Net-Gross Weight	Kg	150-170

**Fogão elétrico de 6 placas quadradas com armário+porta** - Cuisinière électrique de 6 plaques carrées avec armoire+porte - Fogón eléctrico de 6 planchas cuadradas con armário+puerta - 6 square plate electric stove with cupboard+door

**NOVO  
NOUVEAU  
NUEVO  
NEW**



MODELO / MODÈLE / MODELO / MODEL CÓDIGO / CODE / CÓDIGO / CODE	UDF096APEQ	
	5900.017	
<b>Preço / Prix / Precio / Price</b>	€	<b>5.778,00</b>
Dimensões / Dimensions / Dimensiones	mm	1200x900x900
Potência total / Puissance total / Potência total / Total power	kW	18
Tensão / Tension / Tension / Tension	V	400
Potência placas / Puissance plaques / Potência placas / Plates Power	kW	6x3 kW
Dim. placa de fogão / Dim. plaque de poêle / Dim. placa fogón / Stove plate dim.	mm	6x300x300
Peso Líquido-Bruto / Poids Net-Brut / Peso Neto-Bruto / Net-Gross Weight	Kg	194

**Fogão elétrico 6 placas com forno elétrico** - Cuisinière électrique avec four électrique - Fogón eléctrico con - orno eléctrico - Electric stove with electric oven

**NOVO  
NOUVEAU  
NUEVO  
NEW**



MODELO / MODÈLE / MODELO / MODEL CÓDIGO / CODE / CÓDIGO / CODE	UDF094GAPEAPQ	
	5900.017A	
<b>Preço / Prix / Precio / Price</b>	€	<b>5.806,00</b>
Dimensões / Dimensions / Dimensiones	mm	1200x900x900
Potência total / Puissance total / Potência total / Total power	kW	24
Tensão / Tension / Tension / Tension	V	400
Potência placas / Puissance plaques / Potência placas / Plates Power	kW	6x3 kW
Dim. forno e potência / Dim. four puissance / Dim. horno y potencia / Oven dim. and power	mm- kW	545x645x300 -6 kW
Dim. placa de fogão / Dim. plaque de poêle / Dim. placa fogón / Stove plate dim.	mm	6x300x300
Peso / Poids / Peso / Weight	Kg	247





UDI

Cook HIT  
900**PLACAS ARDENTES GÁS - COOK HIT 900**

CUISINIÈRES TOUT FOYER GAZ - COOK HIT 900

PLACAS A GAS - COOK HIT 900

GAS HOT PLATES - COOK HIT 900

**Placa ardente gás com armário+porta** Cuisinière gaz avec armoire+porte - Fogón gas con armario+puerta - Gas plate stove with cupboard+door

MODELO / MODÈLE / MODELO / MODEL CÓDIGO / CODE / CÓDIGO / CODE	UDPA9APG 5900.018	
<b>Preço / Prix / Precio / Price</b>	€	<b>2.488,00</b>
Dimensões / Dimensions / Dimensiones	mm	800x900x900
Potência nominal / Puissance nominale / Potência nominal / Rated power	Qn/kW	5
Potência da placa / Puissance plaque/ Potência de la placa / Plate Power	kW	5
Dim. forno e potência / Dim. four et puissance / Dim. horno y potencia / Oven dim. and power	mm kW	-
Peso Líquido-Bruto / Poids Net-Brut / Peso Neto-Bruto / Net-Gross Weight	Kg	170-190

**Placa ardente gás com forno a gás** - Cuisinière gaz avec four gaz - Fogón gas con horno a gas - Gas plate stove with gas oven

MODELO / MODÈLE / MODELO / MODEL CÓDIGO / CODE / CÓDIGO / CODE	UDPA9FG 5900.020	
<b>Preço / Prix / Precio / Price</b>	€	<b>4.148,00</b>
Dimensões / Dimensions / Dimensiones	mm	800x900x900
Potência nominal / Puissance nominale / Potência nominal / Rated power	Qn/kW	11
Potência da placa / Puissance plaque/ Potência de la placa / Plate Power	kW	5 + 6
Dim. forno e potência / Dim. four et puissance / Dim. horno y potencia / Oven dim. and power	mm kW	545x645x300 - 1x 2/1 GN 6 Kw
Peso Líquido-Bruto / Poids Net-Brut / Peso Neto-Bruto / Net-Gross Weight	Kg	170-190

**PLACA DE INDUÇÃO - COOK HIT 900**

INDUCTION PLATE - COOK HIT 900

PLACA DE INDUCCIÓN - COOK HIT 900

INDUCTION PLATEA - COOK HIT 900

sob pedido  
sur demande  
bajo pedido  
on requestNOVO  
NOUVEAU  
NUEVO  
NEW

MODELO / MODÈLE / MODELO / MODEL CÓDIGO / CODE / CÓDIGO / CODE	UDFI92APE 5900.022	
<b>Preço / Prix / Precio / Price</b>	€	<b>8.768,00</b>
Dimensões / Dimensions / Dimensiones	mm	400x900x900
Potência total / Puissance total / Potência total / Total power	kW	10
Tensão / Tension / Tension / Tension	V	400
Volume / Volume / Volumen / Volume	m3	0,55
Peso / Poids / Peso / Weight	Kg	92

NOVO  
NOUVEAU  
NUEVO  
NEW

MODELO / MODÈLE / MODELO / MODEL CÓDIGO / CODE / CÓDIGO / CODE	UDFI94APE 5900.023	
<b>Preço / Prix / Precio / Price</b>	€	<b>16.807,00</b>
Dimensões / Dimensions / Dimensiones	mm	800x900x900
Potência total / Puissance total / Potência total / Total power	kW	20
Tensão / Tension / Tension / Tension	V	400
Volume / Volume / Volumen / Volume	m3	0,9
Peso / Poids / Peso / Weight	Kg	189

 Placa de Cromoduro  
Placa en Cromo duro  
Plaque Chrome Dur  
Hard Chrome Plate

**Frytop simples liso\*** - Frytop simple lise - Frytop simples liso - Single smooth frytop

MODELO / MODÈLE / MODELO / MODEL CÓDIGO / CODE / CÓDIGO / CODE	UDFT9SLAPG 5900.021	UDFT9SLAPG 5900.021C
<b>Preço / Prix / Precio / Price</b>	€ <b>2.046,00</b>	<b>2.774,00</b>
Dimensões / Dimensions / Dimensiones	mm 400x900x900	400x900x900
Potência nominal / Puissance nominale / Potência nominal / Rated power	Qn/kW 9	9
Dimensões placa / Dimensions plaque / Dimensiones placa / Plate dimensions	mm 392x670x15	392x670x15
Peso / Poids / Peso / Weight	Kg 75	75

**Frytop simples nervurado\*** - Frytop simple strié - Frytop simples ranurado - Single ribbed frytop

MODELO / MODÈLE / MODELO / MODEL CÓDIGO / CODE / CÓDIGO / CODE	UDFT9SNAPG 5900.026
<b>Preço / Prix / Precio / Price</b>	€ <b>2.408,00</b>
Dimensões / Dimensions / Dimensiones	mm 400x900x900
Potência nominal / Puissance nominale / Potência nominal / Rated power	Qn/kW 9
Dimensões placa / Dimensions plaque / Dimensiones placa / Plate dimensions	mm 392x670x15
Peso / Poids / Peso / Weight	Kg 75

 Placa de Cromoduro  
Placa en Cromo duro  
Plaque Chrome Dur  
Hard Chrome Plate

**Frytop duplo liso\*** - Frytop double lise - Frytop doble liso - Double smooth frytop

MODELO / MODÈLE / MODELO / MODEL CÓDIGO / CODE / CÓDIGO / CODE	UDFT9DLAPG 5900.030	UDFT9DLAPG 5900.030C
<b>Preço / Prix / Precio / Price</b>	€ <b>3.073,00</b>	<b>4.084,00</b>
Dimensões / Dimensions / Dimensiones	mm 800x900x900	800x900x900
Potência nominal / Puissance nominale / Potência nominal / Rated power	Qn/kW 18	18
Dimensões placa / Dimensions plaque / Dimensiones placa / Plate dimensions	mm 792x670x15	792x670x15
Peso / Poids / Peso / Weight	Kg 145	145

**Frytop duplo nervurado\*** - Frytop double strié - Frytop doble ranurado - Double ribbed frytop

MODELO / MODÈLE / MODELO / MODEL CÓDIGO / CODE / CÓDIGO / CODE	UDFT9DNAPG 5900.034
<b>Preço / Prix / Precio / Price</b>	€ <b>3.116,00</b>
Dimensões / Dimensions / Dimensiones	mm 800x900x900
Potência nominal / Puissance nominale / Potência nominal / Rated power	Qn/kW 18
Dimensões placa / Dimensions plaque / Dimensiones placa / Plate dimensions	mm 792x670x15
Peso / Poids / Peso / Weight	Kg 145

 Placa de Cromoduro  
Placa en Cromo duro  
Plaque Chrome Dur  
Hard Chrome Plate

**Frytop duplo misto\*** - Frytop double mixte - Frytop doble mixto - Double combi frytop

MODELO / MODÈLE / MODELO / MODEL CÓDIGO / CODE / CÓDIGO / CODE	UDFT9DMAPG 5900.038	UDFT9DMAPG 5900.038C
<b>Preço / Prix / Precio / Price</b>	€ <b>3.126,00</b>	<b>4.157,00</b>
Dimensões / Dimensions / Dimensiones	mm 800x900x900	800x900x900
Potência nominal / Puissance nominale / Potência nominal / Rated power	Qn/kW 18	18
Dimensões placa / Dimensions plaque / Dimensiones placa / Plate dimensions	mm 396+396x670x15	396+396x670x15
Peso / Poids / Peso / Weight	Kg 145	145

\* Com armário+porta | Avec armoire+porte | Con armario+puerta | With cupboard+door



UDI

Cook HIT  
900

FRY-TOPS ELÉTRICOS - COOK HIT 900

GRIDDLES ELECTRIQUES - COOK HIT 900

FRY-TOPS ELÉTRICOS - COOK HIT 900

ELECTRIC FRY-TOP - COOK HIT 900

**Frytop simples liso\*** - Frytop simple lise - Frytop simples liso - Single smooth frytop

MODELO / MODÈLE / MODELO / MODEL	UDFT9SLAPE	
CÓDIGO / CODE / CÓDIGO / CODE	5900.024	
<b>Preço / Prix / Precio / Price</b>	€	<b>2.074,00</b>
Dimensões / Dimensions / Dimensiones	mm	400x900x900
Potência total / Puissance total / Potência total / Total power	kW	6
Tensão / Tension / Tensión / Tension	V	400
Dimensões placa / Dimensions plaque / Dimensiones placa / Plate dimensions	mm	392x670x15
Peso Líquido / Poids Net / Peso Neto / Net Weight	Kg	52

**Frytop simples nervurado\*** - Frytop simple strié - Frytop simples ranurado - Single ribbed frytop

MODELO / MODÈLE / MODELO / MODEL	UDFT9SNAPE	
CÓDIGO / CODE / CÓDIGO / CODE	5900.028	
<b>Preço / Prix / Precio / Price</b>	€	<b>2.640,00</b>
Dimensões / Dimensions / Dimensiones	mm	400x900x900
Potência total / Puissance total / Potência total / Total power	kW	6
Tensão / Tension / Tensión / Tension	V	400
Dimensões placa / Dimensions plaque / Dimensiones placa / Plate dimensions	mm	392x670x15
Peso Líquido / Poids Net / Peso Neto / Net Weight	Kg	52

Placa de Cromoduro  
Placa en Cromo duro  
Plaque Chrome Dur  
Hard Chrome Plate**Frytop duplo liso\*** - Frytop double lise - Frytop doble liso - Double smooth frytop

MODELO / MODÈLE / MODELO / MODEL	UDFT9DLAPE	UDFT9DLAPE	
CÓDIGO / CODE / CÓDIGO / CODE	5900.032	5900.032C	
<b>Preço / Prix / Precio / Price</b>	€	<b>2.968,00</b>	<b>4.149,00</b>
Dimensões / Dimensions / Dimensiones	mm	800x900x900	800x900x900
Potência total / Puissance total / Potência total / Total power	kW	12	12
Tensão / Tension / Tensión / Tension	V	400	400
Dimensões placa / Dimensions plaque / Dimensiones placa / Plate dimensions	mm	792x670x15	792x670x15
Peso Líquido / Poids Net / Peso Neto / Net Weight	Kg	145	145

**Frytop duplo nervurado\*** - Frytop double strié - Frytop doble ranurado - Double ribbed frytop

MODELO / MODÈLE / MODELO / MODEL	UDFT9DNAPE	
CÓDIGO / CODE / CÓDIGO / CODE	5900.036	
<b>Preço / Prix / Precio / Price</b>	€	<b>3.359,00</b>
Dimensões / Dimensions / Dimensiones	mm	800x900x900
Potência total / Puissance total / Potência total / Total power	kW	12
Tensão / Tension / Tensión / Tension	V	400
Dimensões placa / Dimensions plaque / Dimensiones placa / Plate dimensions	mm	792x670x15
Peso Líquido / Poids Net / Peso Neto / Net Weight	Kg	145

**Frytop duplo misto\*** - Frytop double mixte - Frytop doble mixto - Double combi frytop

MODELO / MODÈLE / MODELO / MODEL	UDFT9DMAPE	
CÓDIGO / CODE / CÓDIGO / CODE	5900.040	
<b>Preço / Prix / Precio / Price</b>	€	<b>3.230,00</b>
Dimensões / Dimensions / Dimensiones	mm	800x900x900
Potência total / Puissance total / Potência total / Total power	kW	12
Tensão / Tension / Tensión / Tension	V	400
Dimensões placa / Dimensions plaque / Dimensiones placa / Plate dimensions	mm	396+396x670x15
Peso Líquido / Poids Net / Peso Neto / Net Weight	Kg	145

\* Com armário+porta | Avec armoire+porte | Con armario+puerta | With cupboard+door

OPCIONAIS CookHIT 900 / OPTIONNELLES CookHIT 900 / OPCIONALES CookHIT 900 / CookHIT 900 OPTIONALS 246&gt;248

Consulte condições na pág. 6 • Voir conditions dans la page 6 • Ver condiciones en la pág. 6 • Conditions on page 6

219

## GRELHADORES DE PEDRA LÁVICA GÁS - COOK HIT 900

GRILLES A ROCHE LAVIQUE A GAZ - COOK HIT 900  
PARRILAS DE PIEDRA LÁVICA A GAS - COOK HIT 900  
GAS GRILLS AND LAVA STONE - COOK HIT 900



MODELO / MODÈLE / MODELO / MODEL CÓDIGO / CODE / CÓDIGO / CODE	UDGPL9SAPG 5900.050
<b>Preço / Prix / Precio / Price</b>	€ <b>2.657,00</b>
Dimensões / Dimensions / Dimensiones	mm 400x900x900
Potência nominal / Puissance nominale / Potência nominal / Rated power	Qn/ kW 11
Potência queimadores / Puissance brûleur / Potência quemadores / Burners Power	kW 8,5
Peso Líquido / Poids Net / Peso Neto / Net Weight	Kg 62

**NOVO**  
NOUVEAU  
NUEVO  
NEW



MODELO / MODÈLE / MODELO / MODEL CÓDIGO / CODE / CÓDIGO / CODE	UDGPL92DAPG 5900.053
<b>Preço / Prix / Precio / Price</b>	€ <b>4.541,00</b>
Dimensões / Dimensions / Dimensiones	mm 800x900x900
Potência nominal / Puissance nominale / Potência nominal / Rated power	Qn/ kW 18
Peso Líquido / Poids Net / Peso Neto / Net Weight	Kg 145

## GRELHADORES GÁS A ÁGUA - COOK HIT 900

GRILLES GAZ À L'EAU - COOK HIT 900  
PARRILAS GAS A AGUA - COOK HIT 900  
GAS WATER GRILLS - COOK HIT 900



**NOVO**  
NOUVEAU  
NUEVO  
NEW



MODELO / MODÈLE / MODELO / MODEL CÓDIGO / CODE / CÓDIGO / CODE	UDGA9SAPG 5900.049
<b>Preço / Prix / Precio / Price</b>	€ <b>2.373,00</b>
Dimensões / Dimensions / Dimensiones	mm 400x900x900
Peso Líquido / Poids Net / Peso Neto / Net Weight	Kg 114

**NOVO**  
NOUVEAU  
NUEVO  
NEW



MODELO / MODÈLE / MODELO / MODEL CÓDIGO / CODE / CÓDIGO / CODE	UDGA9DAPG 5900.049A
<b>Preço / Prix / Precio / Price</b>	€ <b>3.862,00</b>
Dimensões / Dimensions / Dimensiones	mm 800x900x900
Peso Líquido / Poids Net / Peso Neto / Net Weight	Kg 220



UDI

Cook HIT  
900

FRITADEIRAS GÁS - COOK HIT 900

FRITEUSES GAS - COOK HIT 900

FREIDORAS A GAS - COOK HIT 900

GAS FRYERS - COOK HIT 900

**Standard: Simples 2-1/2 Cestos | Dupla: 4-1/2 Cestos (140x350x130)**

Standard: Simple 2-1/2 Panier | Double: 4-1/2 Panier (140x350x130) |

Standard: Simples 2-1/2 Cestas | Doble: 4-1/2 Cestas (140x350x130) | Standard:

Single 2-1/2 Basket | Double: 4-1/2 Basket (140x350x130)



MODELO / MODÈLE / MODELO / MODEL CÓDIGO / CODE / CÓDIGO / CODE	UDFR924APG 5900.044
<b>Preço / Prix / Precio / Price</b>	€ <b>3.073,00</b>
Dimensões / Dimensions / Dimensiones	mm 400x900x900
Potência nominal / Puissance nominale / Potência nominal / Rated power	Qn/ kW 18
Potência queimadores / Puissance brûleur / Potência quemadores / Burners Power	kW 3x6
Capacidade cuba / Capacité cuve / Capacidad cuba / Tank capacity	lt 24
Dimensão cuba / Dimensiones cuve / Dimensiones cuba / Tank dimensions	mm 300x400x290
Dimensões cestos / Dim. paniers / Dim. cestas / Basket dim.	mm 140x350x130 <sup>2 x</sup>
Peso Líquido / Poids Net / Peso Neto / Net Weight	Kg 62



MODELO / MODÈLE / MODELO / MODEL CÓDIGO / CODE / CÓDIGO / CODE	UDFR924DAPG 5900.048
<b>Preço / Prix / Precio / Price</b>	€ <b>5.015,00</b>
Dimensões / Dimensions / Dimensiones	mm 800x900x900
Potência nominal / Puissance nominale / Potência nominal / Rated power	Qn/ kW 36
Potência queimadores / Puissance brûleur / Potência quemadores / Burners Power	kW 6x6
Capacidade cuba / Capacité cuve / Capacidad cuba / Tank capacity	lt 24x2
Dimensão cuba / Dimensiones cuve / Dimensiones cuba / Tank dimensions	mm 300x400x290 <sup>2 x</sup>
Dimensões cestos / Dim. paniers / Dim. cestas / Basket dim.	mm 140x350x130 <sup>4 x</sup>
Peso Líquido / Poids Net / Peso Neto / Net Weight	Kg 115



MODELO / MODÈLE / MODELO / MODEL CÓDIGO / CODE / CÓDIGO / CODE		UDFR924APE 5900.042
<b>Preço / Prix / Precio / Price</b>	€	<b>2.551,00</b>
Dimensões / Dimensions / Dimensiones	mm	400x900x900
Potência total / Puissance total / Potência total / Total power	kW	18
Tensão / Tension / Tensión / Tension	V	400
Capacidade cuba / Capacité cuve / Capacidad cuba / Tank capacity	L	24
Dimensão cuba / Dimensiones cuve / Dimensiones cuba / Tank dimensions	mm	320x450x250
Dimensões cestos / Dim. paniers / Dim. cestas / Basket dim.	mm	2 x 140x350x170
Peso Líquido-Bruto / Poids Net-Brut / Peso Neto-Bruto / Net-Gross Weight	Kg	55-65

MODELO / MODÈLE / MODELO / MODEL CÓDIGO / CODE / CÓDIGO / CODE		UDFR924DAPE 5900.046
<b>Preço / Prix / Precio / Price</b>	€	<b>3.856,00</b>
Dimensões / Dimensions / Dimensiones	mm	800x900x900
Potência total / Puissance total / Potência total / Total power	kW	36
Tensão / Tension / Tensión / Tension	V	400
Capacidade cuba / Capacité cuve / Capacidad cuba / Tank capacity	L	24 + 24
Dimensão cuba / Dimensiones cuve / Dimensiones cuba / Tank dimensions	mm	2 x 320x450x250
Dimensões cestos / Dim. paniers / Dim. cestas / Basket dim.	mm	4 x 140x350x170
Peso Líquido / Poids Net / Peso Neto / Net Weight	Kg	98

## AQUECEDOR DE BATATA FRITA COM ARMÁRIO+PORTA

CHAUFFE POMME DE TERRE AVEC ARMOIRE+PORTE

CALENTADOR DE PATATA FRITA CON ARMARIO+PUERTA

FRYED CHIP WARMER WITH CUPBOARD+DOOR



MODELO / MODÈLE / MODELO / MODEL CÓDIGO / CODE / CÓDIGO / CODE		UDABF9APE 5900.084
<b>Preço / Prix / Precio / Price</b>	€	<b>1.529,00</b>
Dimensões / Dimensions / Dimensiones	mm	400x900x900
Potência total / Puissance total / Potência total / Total power	kW	850 W
Tensão / Tension / Tensión / Tension	V	230
Capacidade cuba / Capacité cuve / Capacidad cuba / Tank capacity	L	21
Dimensão cuba / Dimensiones cuve / Dimensiones cuba / Tank dimensions	mm	325x530x150
Dimensões cestos / Dim. paniers / Dim. cestas / Basket dim.	mm	1xGN 1/1x150
Peso Líquido-Bruto / Poids Net-Brut / Peso Neto-Bruto / Net-Gross Weight	Kg	55-70

**Containers não incluídos**  
**Containers pas inclus**  
**Containers no incluido**  
**Containers not included**



UDI

Cook HIT  
900

**COZEDORES DE PASTA - COOK HIT 900**

CUISEURS A PATES - COOK HIT 900

COCEDORES DE PASTA - COOK HIT 900

PASTA COOKERS - COOK HIT 900



**Cozedor de pasta simples a gás\***

Cuiseur pâte simple a gaz  
Cocedor pasta simples a gas  
Gas single pasta cooker



MODELO / MODÈLE / MODELO / MODEL CÓDIGO / CODE / CÓDIGO / CODE	UDCP9SAPG 5900.082	
<b>Preço / Prix / Precio / Price</b>	€	<b>2.521,00</b>
Dimensões / Dimensions / Dimensiones	mm	400x900x900
Potência total / Puissance total / Potência total / Total power	kW	10
Capacidade cuba / Capacité cuve / Capacidad cuba / Tank capacity	L	40
Dimensão cuba / Dimensiones cuve / Dimensiones cuba / Tank dimensions	mm	300x500x245
Dimensões cestos / Dim. paniers / Dim. cestas / Basket dim.	mm	2 x 115x160x255 - 2 x 160x237x255
Peso Líquido / Poids Net / Peso Neto / Net Weight	Kg	79

**Cozedor de pasta simples elétrico\***

Cuiseur pâte simple électrique  
Cocedor pasta simples eléctrico  
Electric single pasta cooker



MODELO / MODÈLE / MODELO / MODEL CÓDIGO / CODE / CÓDIGO / CODE	UDCP9SAPE 5900.058	
<b>Preço / Prix / Precio / Price</b>	€	<b>2.572,00</b>
Dimensões / Dimensions / Dimensiones	mm	400x900x900
Potência total / Puissance total / Potência total / Total power	kW	12
Tensão / Tension / Tensión / Tension	V	400
Capacidade cuba / Capacité cuve / Capacidad cuba / Tank capacity	L	22
Dimensão cuba / Dimensiones cuve / Dimensiones cuba / Tank dimensions	mm	320x450x250
Dimensões cestos / Dim. paniers / Dim. cestas / Basket dim.	mm	2 x 135x135x180 - 2 x 145x270x180
Peso Líquido / Poids Net / Peso Neto / Net Weight	Kg	35

**Cozedor de pasta duplo elétrico\***

Cuiseur pâte double électrique  
Cocedor pasta doble eléctrico con armario+puerta  
Double electric pasta cooker



MODELO / MODÈLE / MODELO / MODEL CÓDIGO / CODE / CÓDIGO / CODE	UDCP9DAPE 5900.060	
<b>Preço / Prix / Precio / Price</b>	€	<b>4.153,00</b>
Dimensões / Dimensions / Dimensiones	mm	800x900x900
Potência total / Puissance total / Potência total / Total power	kW	24
Tensão / Tension / Tensión / Tension	V	400
Capacidade cuba / Capacité cuve / Capacidad cuba / Tank capacity	L	2x35
Dimensão cuba / Dimensiones cuve / Dimensiones cuba / Tank dimensions	mm	2 x 320x450x250
Dimensões cestos / Dim. paniers / Dim. cestas / Basket dim.	mm	4 x 135x135x180 - 4 x 145x270x180
Peso Líquido / Poids Net / Peso Neto / Net Weight	Kg	75

\* Com armário+porta | Avec armoire+porte | Con armario+puerta | With cupboard+door



Containers não incluídos  
Containers pas inclus  
Containers no incluido  
Containers not included

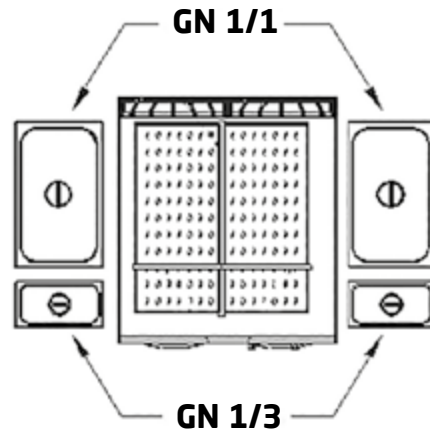

UDBM9DAPE

**Banho-maria simples elétrico com armário+porta**

Bain-marie simple électrique avec armoire+porte  
Baño maría simples eléctrico con armario+puerta  
Single electric bain-marie with cupboard+door



MODELO / MODÈLE / MODELO / MODEL CÓDIGO / CODE / CÓDIGO / CODE		UDBM9SAPE 5900.054
<b>Preço / Prix / Precio / Price</b>	€	<b>2.169,00</b>
Dimensões / Dimensions / Dimensiones	mm	400x900x900
Potência total / Puissance total / Potência total / Total power	kW	1,5
Tensão / Tension / Tensión / Tension	V	230
Capacidade cuba / Capacité cuve / Capacidad cuba / Tank capacity	L	21
Dimensão cuba / Dimensiones cuve / Dimensiones cuba / Tank dimensions	mm	1 x GN 1/1x150 - 1xGN 1/3x150
Peso Líquido-Bruto / Poids Net-Brut / Peso Neto-Bruto / Net-Gross Weight	Kg	55-65

**Banho-maria duplo elétrico com armário+porta**

Bain-marie double électrique avec armoire+porte  
Baño maría doble eléctrico con armario+puerta  
Double electric bain-marie with cupboard+door



MODELO / MODÈLE / MODELO / MODEL CÓDIGO / CODE / CÓDIGO / CODE		UDBM9DAPE 5900.056
<b>Preço / Prix / Precio / Price</b>	€	<b>2.968,00</b>
Dimensões / Dimensions / Dimensiones	mm	800x900x900
Potência total / Puissance total / Potência total / Total power	kW	4
Tensão / Tension / Tensión / Tension	V	230
Capacidade cuba / Capacité cuve / Capacidad cuba / Tank capacity	L	42
Dimensão cuba / Dimensiones cuve / Dimensiones cuba / Tank dimensions	mm	2 xGN 1/1x150 - 2 x GN 1/3x150
Peso Líquido-Bruto / Poids Net-Brut / Peso Neto-Bruto / Net-Gross Weight	Kg	65-75

**Banho-maria duplo gás com armário+porta**

Bain-marie double gaz avec armoire+porte  
Baño maría doble gas con armario+puerta  
Double gas bain-marie with cupboard+door



MODELO / MODÈLE / MODELO / MODEL CÓDIGO / CODE / CÓDIGO / CODE		UDBM9DAPG 5900.057
<b>Preço / Prix / Precio / Price</b>	€	<b>4.241,00</b>
Dimensões / Dimensions / Dimensiones	mm	800x900x900
Potência total / Puissance total / Potência total / Total power	kW	3
Tensão / Tension / Tensión / Tension	V	230
Capacidade cuba / Capacité cuve / Capacidad cuba / Tank capacity	L	42
Dimensão cuba / Dimensiones cuve / Dimensiones cuba / Tank dimensions	mm	2 xGN 1/1x150 - 2 xGN 1/3x150
Peso Líquido-Bruto / Poids Net-Brut / Peso Neto-Bruto / Net-Gross Weight	Kg	105

 NOVO  
NOUVEAU  
NUEVO  
NEW

 elétrico  
électrique  
eléctrico  
electric

 gás  
gaz  
gas  
gas





UDI

Cook HIT  
900

ELEMENTOS NEUTROS - COOK HIT 900

ÉLÉMENTS NEUTRES - COOK HIT 900

ELEMENTOS NEUTROS - COOK HIT 900

NEUTRAL UNITS - COOK HIT 900



**Elemento neutro simples com armário+porta**

Élément neutre simple avec armoire+porte

Elemento neutro simples con armario+puerta

Single neutral unit with cupboard+door



MODELO / MODÈLE / MODELO / MODEL		UDEN9SAP
CÓDIGO / CODE / CÓDIGO / CODE		5900.078
<b>Preço / Prix / Precio / Price</b>	€	<b>1.455,00</b>
Dimensões / Dimensions / Dimensiones	mm	400x900x900
Volume / Volume / Volume / Volume	m <sup>3</sup>	0,51
Peso Líquido / Poids Net / Peso Neto / Net Weight	Kg	50

**Elemento neutro duplo com armário+porta**

Élément neutre double avec armoire+porte

Elemento neutro doble con armario+puerta

Double neutral unit with cupboard+door



MODELO / MODÈLE / MODELO / MODEL		UDEN9DAP
CÓDIGO / CODE / CÓDIGO / CODE		5900.080
<b>Preço / Prix / Precio / Price</b>	€	<b>1.690,00</b>
Dimensões / Dimensions / Dimensiones	mm	800x900x900
Volume / Volume / Volume / Volume	m <sup>3</sup>	0,97
Peso Líquido / Poids Net / Peso Neto / Net Weight	Kg	60

**AQUECIMENTO COM ÓLEO TÉRMICO EM CIRCUITO HERMÉTICO**

 CHAUFFAGE A L'HUILE THERMIQUE EN CIRCUIT HERMETIC  
 CALEFACCIÓN CON ACEITE TÉRMICO EN CIRCUITO HERMÉTICO  
 HEATING WITH THERMAL OIL IN HERMETIC CIRCUIT

**Cuba Aço Inox 304**

 Cuba Acero Inox 304  
 Cuve Acier Inox 304  
 Stainless Steel 304 Vat

**Marmita eléctrica - Aquecimento Indireto**

 Marmite électrique - Chauffage indirect  
 Marmita eléctrica - Calefacción indirecta  
 Electric boiling pan - Indirect heating

**Marmita a gás - Aquecimento Indireto**

 Marmite gaz - Chauffage indirect  
 Marmita gas - Calefacción indirecta  
 Gas boiling pan - Indirect heating

**Marmita a gás - Aquecimento Direto**

 Marmite gaz - Chauffage direct  
 Marmita gas - Calefacción directa  
 Gas boiling pan - Direct heating

 NOVO  
 NOUVEAU  
 NUEVO  
 NEW

 eléctrico  
 électrique  
 eléctrico  
 electric

 gás  
 gaz  
 gas  
 gas

**MAIOR EFICIÊNCIA**  
 O óleo térmico mantém a temperatura estabilizada

**FACILIDADE UTILIZAÇÃO**  
 Sem necessidade de reabastecimento diário da dupla câmara.

**INCREASED EFFICIENCY**

 Easy to use  
 No need for daily restocking of the double chamber.

**EFFICACITÉ ACCRUE**

 Facilité d'utilisation  
 Pas besoin de réapprovisionnement quotidien de la double chambre.

**MAYOR EFICIENCIA**

 Facilidad de uso  
 No hay necesidad de reposición diaria de la doble cámara

MODELO / MODÈLE / MODELO / MODEL CÓDIGO / CODE / CÓDIGO / CODE	UDM9150IE 5900.072
<b>Preço / Prix / Precio / Price</b>	<b>€ 7.765,00</b>
Dimensões / Dimensions / Dimensiones	mm 800x900x900
Potência total / Puissance total / Potência total / Total power	kW 12
Tensão / Tension / Tensión / Tension	V 400
Capacidade cuba / Capacité cuve / Capacidad cuba / Tank capacity	L 150
Dimensão cuba / Dimensiones cuve / Dimensiones cuba / Tank dimensions	mm 590x600
Peso Líquido / Poids Net / Peso Neto / Net Weight	Kg 180

MODELO / MODÈLE / MODELO / MODEL CÓDIGO / CODE / CÓDIGO / CODE	UDM9150IG 5900.070
<b>Preço / Prix / Precio / Price</b>	<b>€ 7.809,00</b>
Dimensões / Dimensions / Dimensiones	mm 800x900x900
Potência total / Puissance total / Potência total / Total power	kW 20
Tensão / Tension / Tensión / Tension	V 230
Potência nominal / Puissance nominale / Potência nominal / Rated power	Qn/ kW 20,5
Potência dos queimadores (individual) / Puissance du brûleur (individuel) Potência de los quemadores (individual) / Burners Power (individual)	kW 20,5
Capacidade cuba / Capacité cuve / Capacidad cuba / Tank capacity	L 150
Dimensão cuba / Dimensiones cuve / Dimensiones cuba / Tank dimensions	mm 590x600
Peso Líquido-Bruto / Poids Net-Brut / Peso Neto-Bruto / Net-Gross Weight	Kg 165-180

MODELO / MODÈLE / MODELO / MODEL CÓDIGO / CODE / CÓDIGO / CODE	UDM9150DG 5900.071
<b>Preço / Prix / Precio / Price</b>	<b>€ 6.049,00</b>
Dimensões / Dimensions / Dimensiones	mm 800x900x900
Potência total / Puissance total / Potência total / Total power	kW 20
Tensão / Tension / Tensión / Tension	V 230
Potência nominal / Puissance nominale / Potência nominal / Rated power	Qn/ kW 20,5
Potência dos queimadores (individual) / Puissance du brûleur (individuel) Potência de los quemadores (individual) / Burners Power (individual)	kW 20,5
Capacidade cuba / Capacité cuve / Capacidad cuba / Tank capacity	L 150
Dimensão cuba / Dimensiones cuve / Dimensiones cuba / Tank dimensions	mm 590x600
Peso Líquido-Bruto / Poids Net-Brut / Peso Neto-Bruto / Net-Gross Weight	Kg 138-150



UDI

Cook HIT  
900**MARMITAS - COOK HIT 900**

MARMITES - COOK HIT 900

MARMITAS - COOK HIT 900

BOILING PANS - COOK HIT 900

**AQUECIMENTO COM ÓLEO TÉRMICO EM CIRCUITO HERMÉTICO**CHAUFFAGE A L'HUILE THERMIQUE EN CIRCUIT HERMETIC  
CALEFACCIÓN CON ACEITE TÉRMICO EN CIRCUITO HERMÉTICO  
HEATING WITH THERMAL OIL IN HERMETIC CIRCUIT**Cuba Aço Inox 304**Cuba Acero Inox 304  
Cuve Acier Inox 304  
Stainless Steel 304 Vat**INCREASED EFFICIENCY**Easy to use  
No need for daily restocking of the double chamber.**EFFICACITÉ ACCRUE**Facilité d'utilisation  
Pas besoin de réapprovisionnement quotidien de la double chambre.**MAYOR EFICIENCIA**Facilidad de uso  
No hay necesidad de reposición diaria de la doble cámara**Marmita elétrica - Aquecimento Indireto**Marmite électrique - Chauffage indirect  
Marmita eléctrica - Calefacción indirecta  
Electric boiling pan - Indirect heating

MODELO / MODÈLE / MODELO / MODEL CÓDIGO / CODE / CÓDIGO / CODE	UDM9250IE 5900.076
<b>Preço / Prix / Precio / Price</b>	<b>€ 13.090,00</b>
Dimensões / Dimensions / Dimensiones	mm 1200x900x900
Potência total / Puissance total / Potência total / Total power	kW 24
Tensão / Tension / Tensión / Tension	V 400
Capacidade cuba / Capacité cuve / Capacidad cuba / Tank capacity	L 250
Dimensão cuba / Dimensiones cuve / Dimensiones cuba / Tank dimensions	mm 955x525x525
Peso Líquido / Poids Net / Peso Neto / Net Weight	Kg 220

**Marmita a gás - Aquecimento Indireto**Marmite gaz - Chauffage indirect  
Marmita gas - Calefacción indirecta  
Gas boiling pan - Indirect heating

MODELO / MODÈLE / MODELO / MODEL CÓDIGO / CODE / CÓDIGO / CODE	UDM9250IG 5900.074
<b>Preço / Prix / Precio / Price</b>	<b>€ 13.202,00</b>
Dimensões / Dimensions / Dimensiones	mm 1200x900x900
Potência total / Puissance total / Potência total / Total power	kW 30
Tensão / Tension / Tensión / Tension	V 230
Potência nominal / Puissance nominale / Potência nominal / Rated power	Qn/ kW 30,75
Potência dos queimadores (individual) / Puissance du brûleur (individuel) Potência de los quemadores (individual) / Burners Power (individual)	kW 30,75
Capacidade cuba / Capacité cuve / Capacidad cuba / Tank capacity	L 250
Dimensão cuba / Dimensiones cuve / Dimensiones cuba / Tank dimensions	mm 956x525x525
Peso Líquido / Poids Net / Peso Neto / Net Weight	Kg 275

**Marmita a gás - Aquecimento Direto**Marmite gaz - Chauffage direct  
Marmita gas - Calefacción directa  
Gas boiling pan - Direct heating

MODELO / MODÈLE / MODELO / MODEL CÓDIGO / CODE / CÓDIGO / CODE	UDM9250DG 5900.075
<b>Preço / Prix / Precio / Price</b>	<b>€ 8.939,00</b>
Dimensões / Dimensions / Dimensiones	mm 1200x900x900
Potência total / Puissance total / Potência total / Total power	kW 30
Tensão / Tension / Tensión / Tension	V 230
Potência nominal / Puissance nominale / Potência nominal / Rated power	Qn/ kW 30,75
Potência dos queimadores (individual) / Puissance du brûleur (individuel) Potência de los quemadores (individual) / Burners Power (individual)	kW 30,75
Capacidade cuba / Capacité cuve / Capacidad cuba / Tank capacity	L 250
Dimensão cuba / Dimensiones cuve / Dimensiones cuba / Tank dimensions	mm 956x525x525
Peso Líquido / Poids Net / Peso Neto / Net Weight	Kg 275

NOVO  
NOUVEAU  
NUEVO  
NEWelétrico  
électrique  
eléctrico  
electricgás  
gaz  
gas  
gas

OPCIONAIS CookHIT 900 / OPTIONNELLES CookHIT 900 / OPCIONALES CookHIT 900 / CookHIT 900 OPTIONALS 246&gt;248



**Cuba Aço Inox 304**  
Cuba Acero Inox 304  
Cuve Acier Inox 304  
Stainless Steel 304 Vat

**VERSÁTIL**

Permite preparar Arroz, Sopas, Fritos, Grelhados, Estufados e manter temperatura de alimentos em banho maria.

**VERSATILE**

Permet préparer le riz, soupes, frits, grillés, ragoûts et maintenir la température des aliments au bain-marie.

**VERSÁTIL**

Permite preparar el arroz, sopas, fritos, a la parrilla, asadas y mantener la temperatura de alimentos en baño de agua.

**VERSATILITY**

Allows preparation of rice, soups, fried and grilled food, stews and maintain food temperature in water bath.



MODELO / MODÈLE / MODELO / MODEL CÓDIGO / CODE / CÓDIGO / CODE	UDFB980G	
<b>Preço / Prix / Precio / Price</b>	<b>€</b>	<b>5.310,00</b>
Dimensões / Dimensions / Dimensiones	mm	800x900x900
Tensão/Tension Tension / Tension	V	230
Potência nominal / Puissance nominale / Potência nominal / Rated power	Qn/ kW	20
Potência queimadores /Puissance brûleur /Potência quemadores /Burners Power	kW	20,5
Capacidade cuba / Capacité cuve / Capacidad cuba / Tank capacity	L	80
Peso Líquido /Poids Net /Peso Neto /Net Weight	Kg	155



MODELO / MODÈLE / MODELO / MODEL CÓDIGO / CODE / CÓDIGO / CODE	UDFB9120G	
<b>Preço / Prix / Precio / Price</b>	<b>€</b>	<b>7.086,00</b>
Dimensões / Dimensions / Dimensiones	mm	1200x900x900
Tensão/Tension Tension / Tension	V	230
Potência nominal / Puissance nominale / Potência nominal / Rated power	Qn/ kW	30
Potência queimadores /Puissance brûleur /Potência quemadores /Burners Power	kW	30,75
Capacidade cuba / Capacité cuve / Capacidad cuba / Tank capacity	L	120
Peso Líquido-Bruto /Poids Net-Brut /Peso Neto-Bruto /Net-Gross Weight	Kg	165-185



UDI

Cook HIT  
900

**FRITADEIRAS BASCULANTES ELÉTRICAS - COOK HIT 900**

FRITEUSE BASCULANT ÉLECTRIQUE - COOK HIT 900

FREIDORAS BASCULANTES ELÉCTRICAS - COOK HIT 900

ELECTRIC TILTING FRYERS - COOK HIT 900



**Cuba Aço Inox 304**  
Cuba Acero Inox 304  
Cuve Acier Inox 304  
Stainless Steel 304 Vat



MODELO / MODÈLE / MODELO / MODEL CÓDIGO / CODE / CÓDIGO / CODE		UDFB980E 5900.068
<b>Preço / Prix / Precio / Price</b>	€	<b>5.465,00</b>
Dimensões / Dimensions / Dimensiones	mm	800x900x900
Potência total / Puissance total / Potência total / Total power	kW	12
Tensão / Tension / Tensión / Tension	V	400
Capacidade cuba / Capacité cuve / Capacidad cuba / Tank capacity	L	80
Peso Líquido-Bruto / Poids Net-Brut / Peso Neto-Bruto / Net-Gross Weight	Kg	155



MODELO / MODÈLE / MODELO / MODEL CÓDIGO / CODE / CÓDIGO / CODE		UDFB9120E 5900.069
<b>Preço / Prix / Precio / Price</b>	€	<b>6.928,00</b>
Dimensões / Dimensions / Dimensiones	mm	1200x900x900
Potência total / Puissance total / Potência total / Total power	kW	18
Tensão / Tension / Tensión / Tension	V	400
Capacidade cuba / Capacité cuve / Capacidad cuba / Tank capacity	L	120
Peso Líquido-Bruto / Poids Net-Brut / Peso Neto-Bruto / Net-Gross Weight	Kg	165



elétrico  
eléctrico  
electric



gás  
gaz  
gas  
gas

OPCIONAIS CookHIT 900 / OPTIONNELLES CookHIT 900 / OPCIONALES CookHIT 900 / CookHIT 900 OPTIONALS 246>248



DESENHOS TÉCNICOS  
DESSINS TECHNIQUES  
DIBUJOS TÉCNICOS  
TECHNICAL DRAWINGS

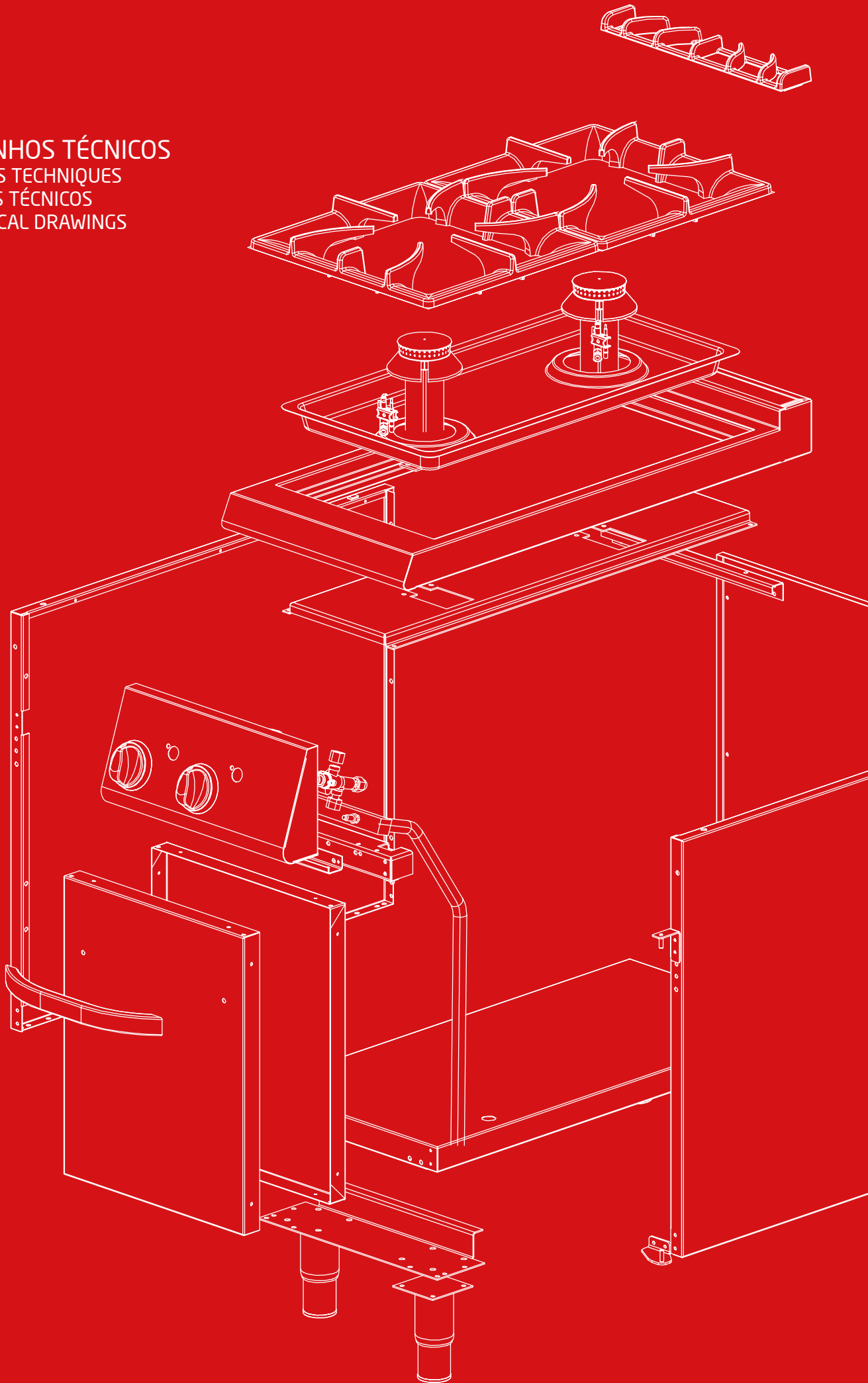



FOGÕES GÁS  
CUISINIÈRES GAS  
COCINAS GAS  
GAS RANGE  
**UDF092APG**  
5900.002

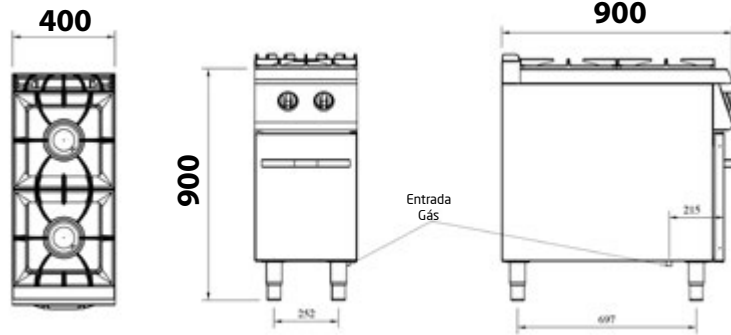

FOGÕES GÁS  
CUISINIÈRES GAS  
COCINAS GAS  
GAS RANGE  
**UDF094APG**  
5900.004

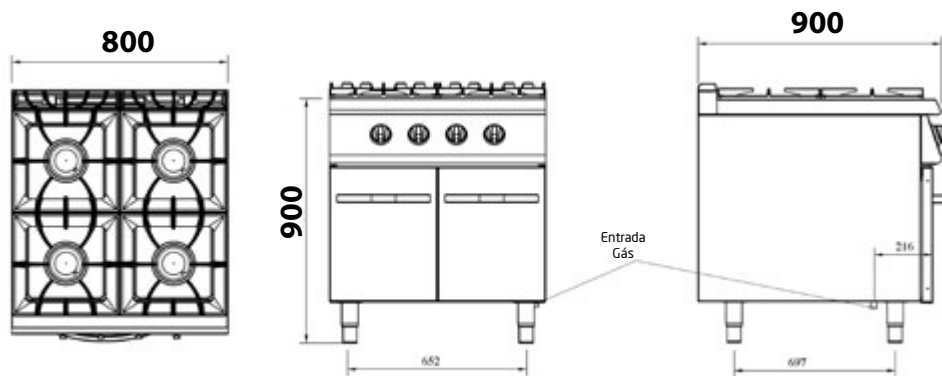

FOGÕES GÁS  
CUISINIÈRES GAS  
COCINAS GAS  
GAS RANGE  
**UDF096FMG**  
5900.006







UDI

Cook HIT  
900

**COOK HIT 900 - DESENHOS TÉCNICOS**

COOK HIT 900 - DESSINS TECHNIQUES

COOK HIT 900 - DIBUJOS TÉCNICOS

COOK HIT 900 - TECHNICAL DRAWINGS



FOGÕES GÁS  
CUISINIÈRES GAS  
COCINAS GAS  
GAS RANGE  
**UDF094FG**  
5900.008

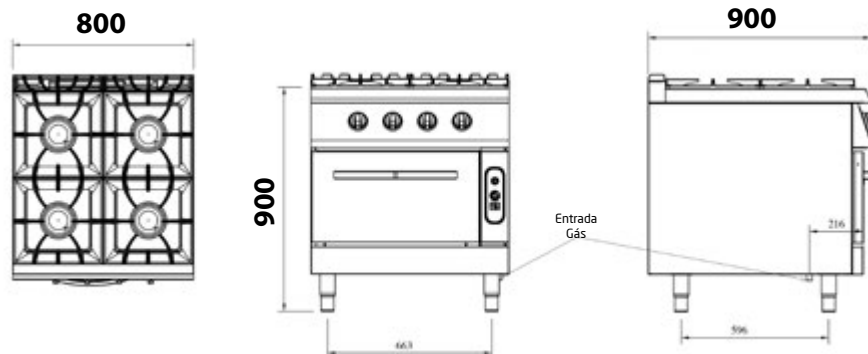

FOGÕES GÁS  
CUISINIÈRES GAS  
COCINAS GAS  
GAS RANGE  
**UDF096FG**  
5900.010

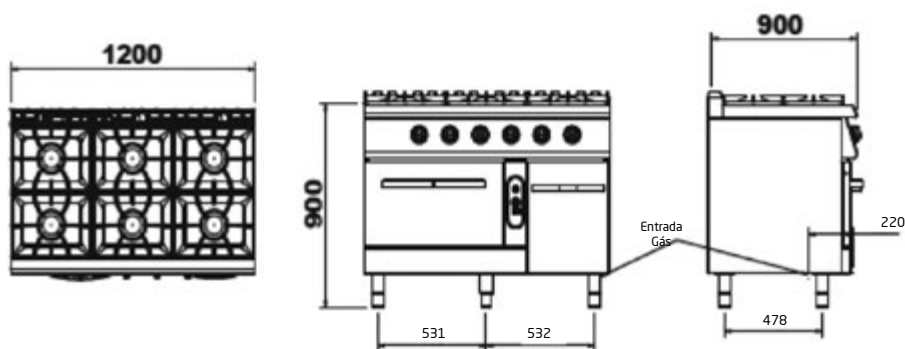

FOGÕES ELÉTRICOS  
CUISINIÈRES ELECTRIQUES  
COCINAS ELÉCTRICAS  
ELECTRIC RANGE  
**UDF092APEQ**  
5900.012

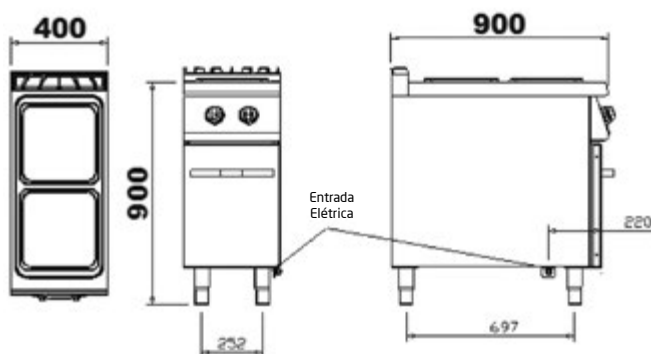

FOGÕES ELÉTRICOS  
CUISINIÈRES ELECTRIQUES  
COCINAS ELÉCTRICAS  
ELECTRIC RANGE  
**UDF094APEQ**  
5900.013

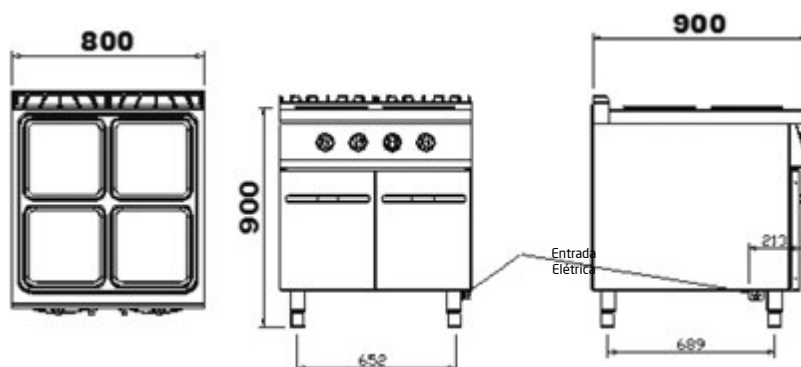



FOGÕES ELÉTRICOS  
CUISINIÈRES ÉLECTRIQUES  
COCINAS ELÉCTRICAS  
ELECTRIC RANGE

**UDF094AFEQ**

5900.016

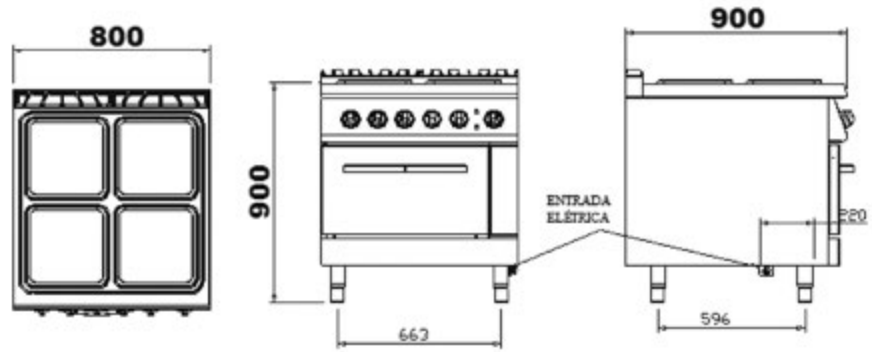

PLACAS ARDENTES A GÁS  
CUISINIÈRES TOUT FOYER GAZ  
PLACAS A GAS  
GAS HOT PLATES

**UDPA9APG**

5900.018

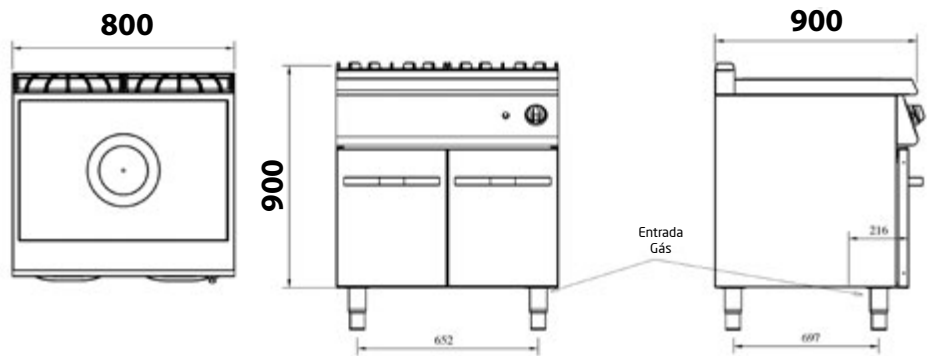

PLACAS ARDENTES A GÁS  
CUISINIÈRES TOUT FOYER GAZ  
PLACAS A GAS  
GAS HOT PLATES

**UDPA9FG**

5900.020

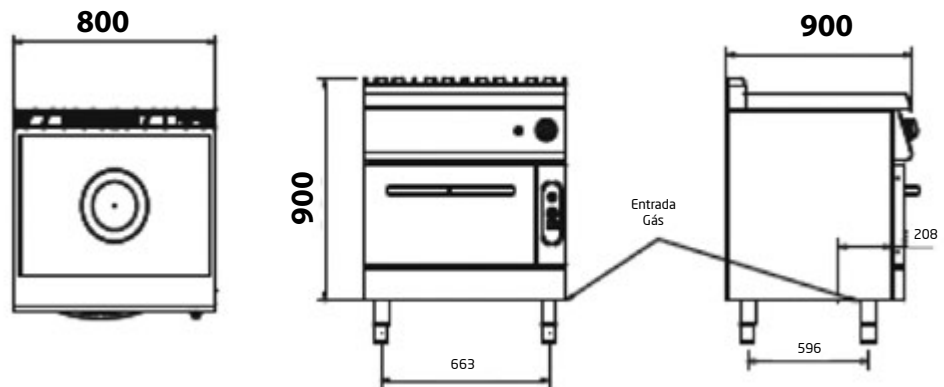

FRY-TOPS A GÁS  
GAS FRY-TOP  
FRY-TOPS A GAS  
GAS FRY-TOP

**UDFT9SLAPG**

5900.021

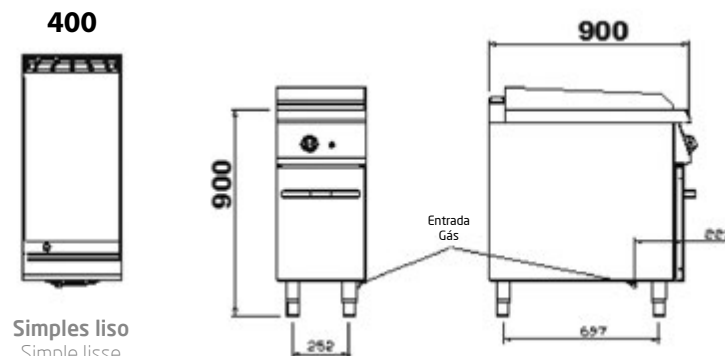

Simple liso  
Simple lisse  
Simple liso  
Single smooth



UDI

Cook HIT  
900

**COOK HIT 900 - DESENHOS TÉCNICOS**

COOK HIT 900 - DESSINS TECHNIQUES

COOK HIT 900 - DIBUJOS TÉCNICOS

COOK HIT 900 - TECHNICAL DRAWINGS



FRY-TOPS A GÁS  
GAS FRY-TOP  
FRY-TOPS A GAS  
GAS FRY-TOP  
**UDFT9SNAPG**  
5900.026



**Simple Nervurado**  
Simple Strié  
Simple Ranurado  
Simple Ribbed

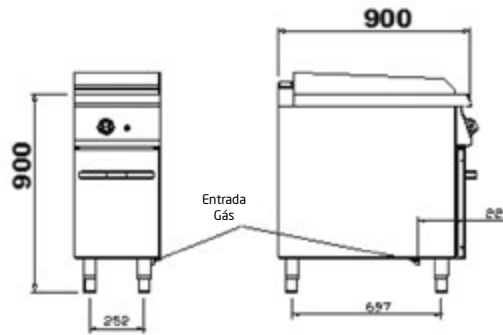

FRY-TOPS A GÁS  
GAS FRY-TOP  
FRY-TOPS A GAS  
GAS FRY-TOP  
**UDFT9DLAPG**  
5900.030



**Duplo liso**  
Double lisse  
Doble liso  
Double smooth

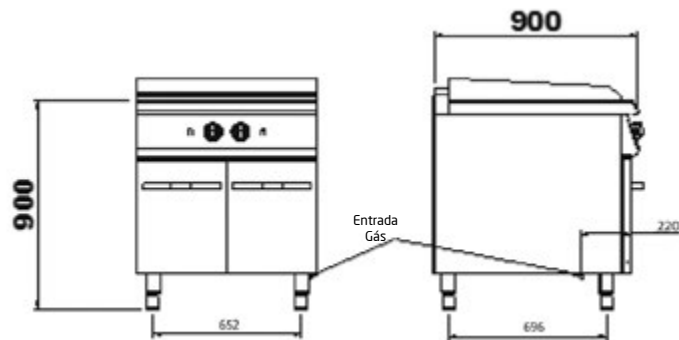

FRY-TOPS A GÁS  
GAS FRY-TOP  
FRY-TOPS A GAS  
GAS FRY-TOP  
**UDFT9DNAPG**  
5900.034

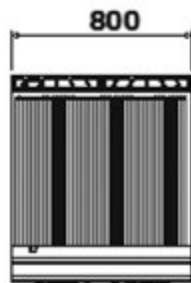

**Duplo nervurado**  
Double strié  
Doble ranurado  
Double ribbed

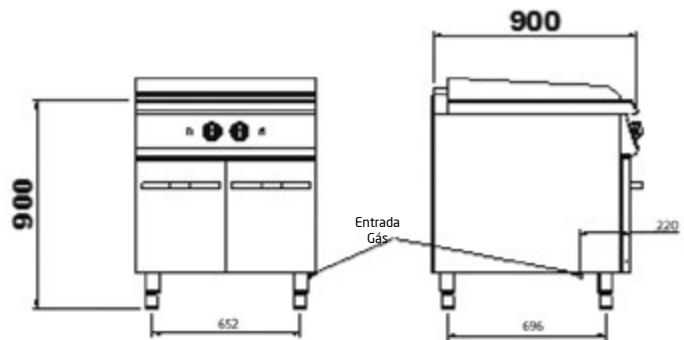

FRY-TOPS A GÁS  
GAS FRY-TOP  
FRY-TOPS A GAS  
GAS FRY-TOP  
**UDFT9DMAPG**  
5900.038

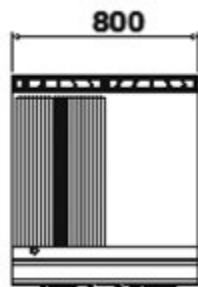

**Duplo misto**  
Double mixte  
Doble mixto  
Double combi

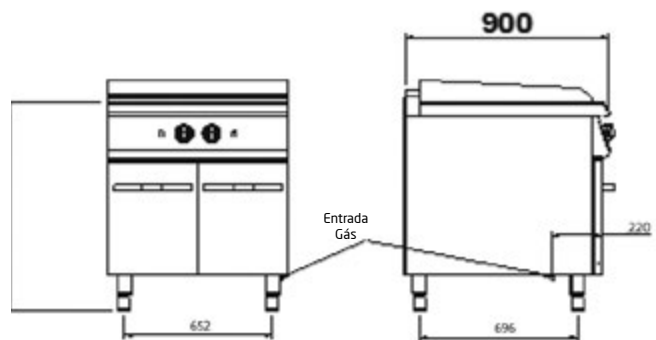



FRY-TOPS ELÉTRICOS  
GRIDDLES ÉLECTRIQUES  
FRY-TOPS ELÉTRICOS  
ELECTRIC FRY-TOP

**UDFT9SLAPE**

5900.024

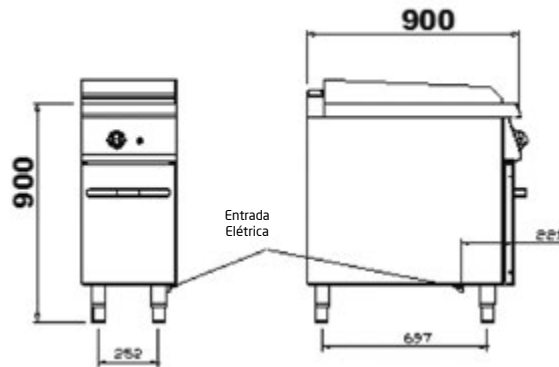

**Simple liso**  
Simple lisse  
Simple liso  
Single smooth

FRY-TOPS ELÉTRICOS  
GRIDDLES ÉLECTRIQUES  
FRY-TOPS ELÉTRICOS  
ELECTRIC FRY-TOP

**UDFT9SNAPE**

5900.028

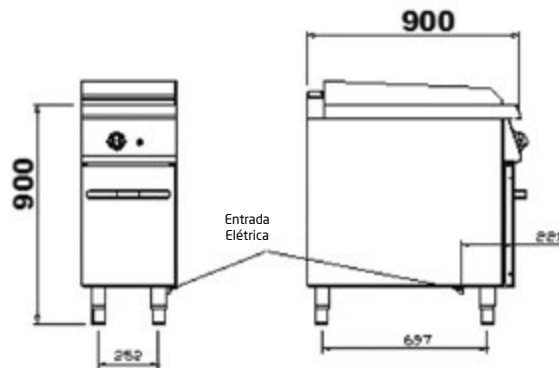

**Simple nervurado**  
Simple strié  
Simple ranurado  
Single ribbed

FRY-TOPS ELÉTRICOS  
GRIDDLES ÉLECTRIQUES  
FRY-TOPS ELÉTRICOS  
ELECTRIC FRY-TOP

**UDFT9DLAPE**

5900.032

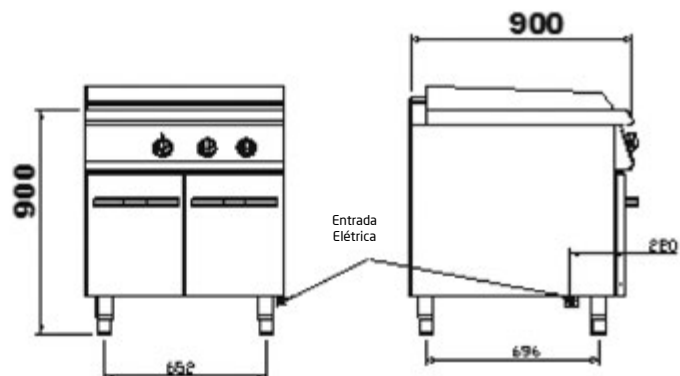

**Duplo liso**  
Double lisse  
Doble liso  
Double smooth



UDI

Cook HIT  
900

**COOK HIT 900 - DESENHOS TÉCNICOS**

COOK HIT 900 - DESSINS TECHNIQUES

COOK HIT 900 - DIBUJOS TÉCNICOS

COOK HIT 900 - TECHNICAL DRAWINGS



FRY-TOPS ELÉTRICOS  
GRIDDLES ELÉCTRIQUES  
FRY-TOPS ELÉCTRICOS  
ELECTRIC FRY-TOP

**UDFT9DNAPE**

5900.036

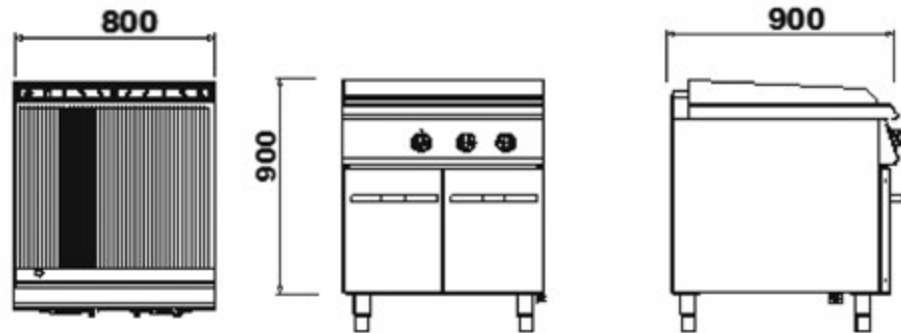

**Duplo nervurado**  
Double strié  
Doble ranurado  
Double ribbed

FRY-TOPS ELÉTRICOS  
GRIDDLES ELÉCTRIQUES  
FRY-TOPS ELÉCTRICOS  
ELECTRIC FRY-TOP

**UDFT9DMAPE**

5900.040

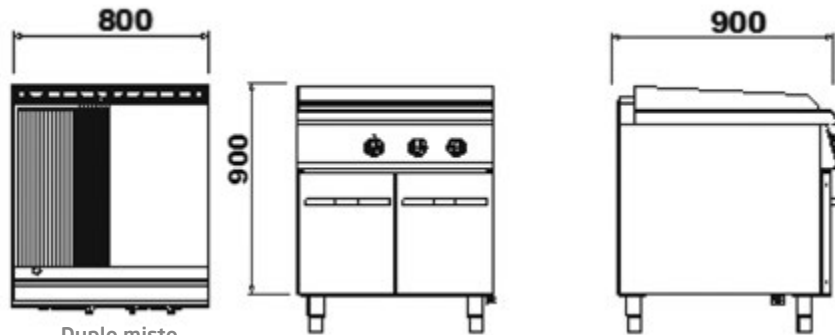

**Duplo misto**  
Double mixte  
Doble mixto  
Double combi

FRITADEIRAS ELÉTRICAS  
FRITEUSES ELECTRIQUES  
FREIDORAS ELÉCTRICAS  
ELECTRIC FRYERS

**UDFR924APE**

5900.042

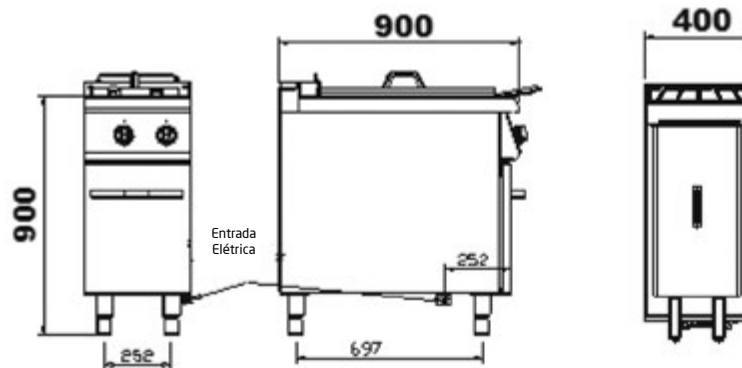

**Simples**  
Simple  
Simples  
Single



FRITADEIRAS ELÉTRICAS  
FRITEUSES ELECTRIQUES  
FREIDORAS ELÉCTRICAS  
ELECTRIC FRYERS

**UDFR924DAPE**

5900.046

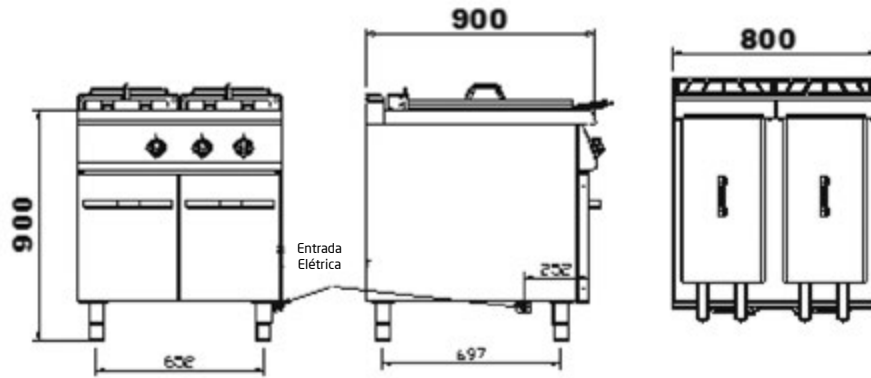

**Dupla**

Double

Doble

Double

FRITADEIRAS A GÁS  
FRITEUSES GAS  
FREIDORAS A GAS  
GAS FRYERS

**UDFR924APG**

5900.044

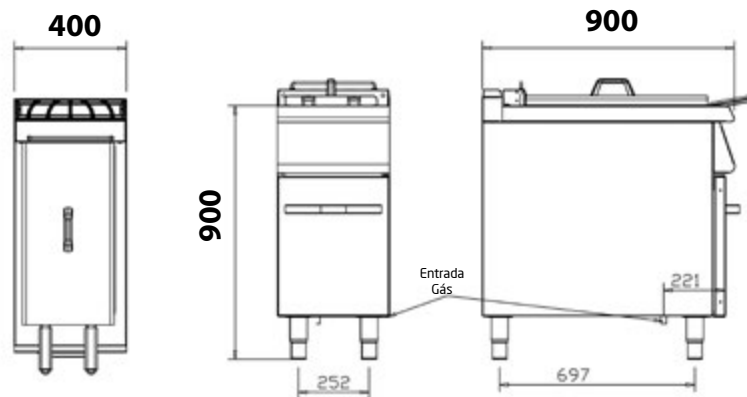

**Simple**

Simple

Simple

Single

FRITADEIRAS A GÁS  
FRITEUSES GAS  
FREIDORAS A GAS  
GAS FRYERS

**UDFR924DAPG**

5900.048

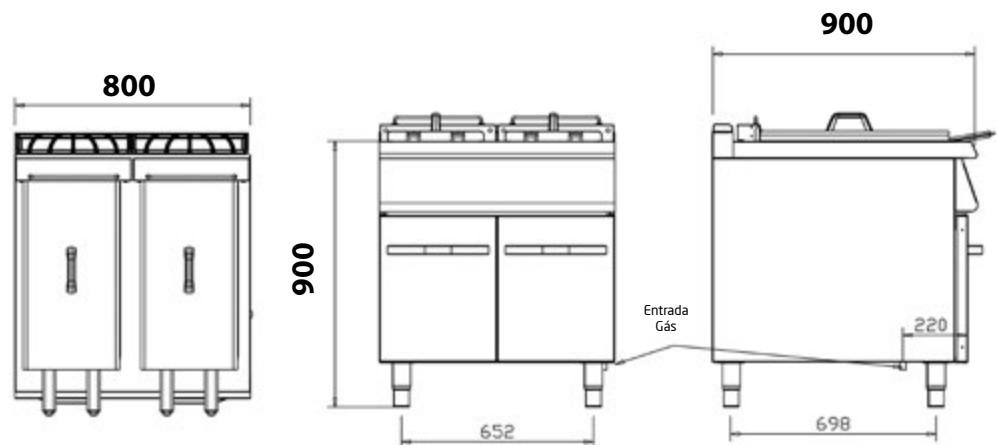

**Dupla**

Double

Doble

Double



UDI

Cook HIT  
900

**COOK HIT 900 - DESENHOS TÉCNICOS**

COOK HIT 900 - DESSINS TECHNIQUES

COOK HIT 900 - DIBUJOS TÉCNICOS

COOK HIT 900 - TECHNICAL DRAWINGS



GRELHADORES DE PEDRA LÁVICA A GÁS  
GRILLES A ROCHE LAVIQUE A GAZ  
PARRILLAS DE PIEDRA LÁVICA  
GAS AND LAVA STONE GRILLS

**UDGPL9SAPG**

5900.050

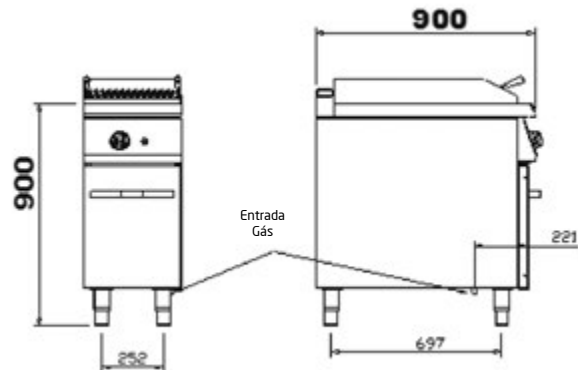

Simple  
Simple  
Simple  
Single

GRELHADORES DE PEDRA LÁVICA A GÁS  
GRILLES A ROCHE LAVIQUE A GAZ  
PARRILLAS DE PIEDRA LÁVICA  
GAS AND LAVA STONE GRILLS

**UDGPL9DAPG**

5900.052

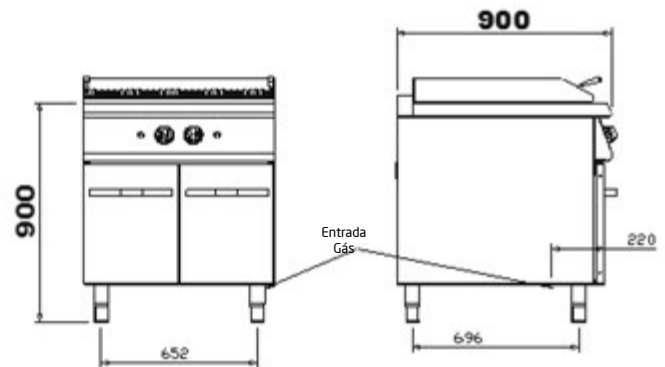

Dupla  
Double  
Doble  
Double

BANHOS-MARIA  
BAIN-MARIE  
BAÑOS MARÍA  
BAIN-MARIES

**UDBM9SAPE**

5900.054

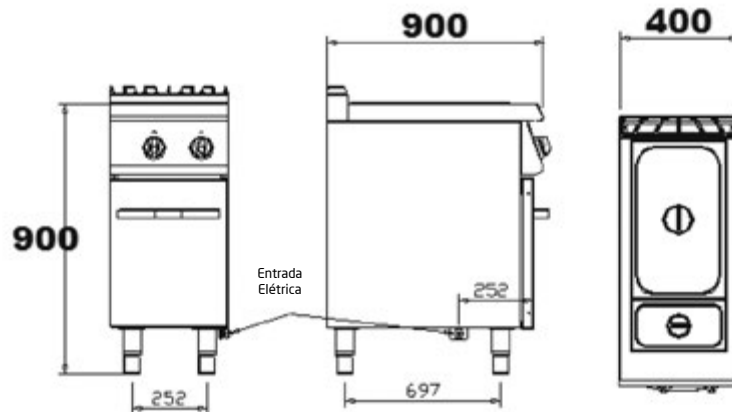

Simple  
Simple  
Simple  
Single



BANHOS-MARIA  
BAIN-MARIE  
BAÑOS MARÍA  
BAIN-MARIES  
**UDBM9DAPE**  
5900.056

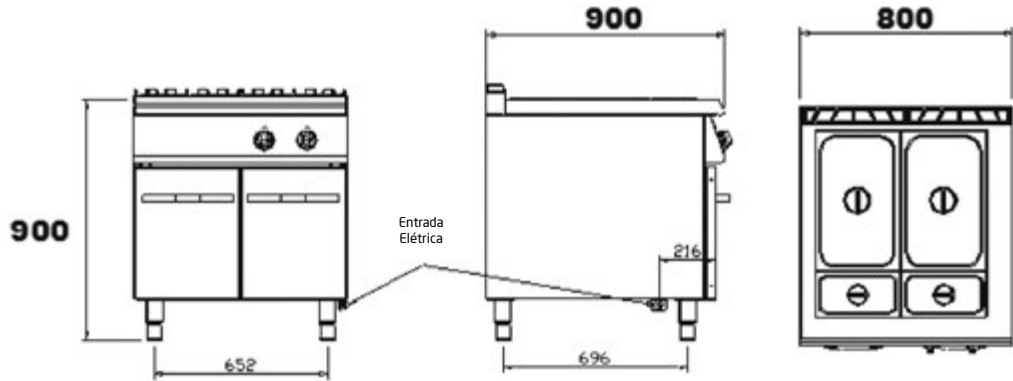

**Duplo**  
Double  
Doble  
Double

COZEDORES DE PASTA ELÉTRICOS  
CUISEURS A PATES ELECTRIQUES  
COCEDORES DE PASTA ELÉTRICOS  
ELECTRIC PASTA COOKERS  
**UDCP9SAPE**  
5900.058

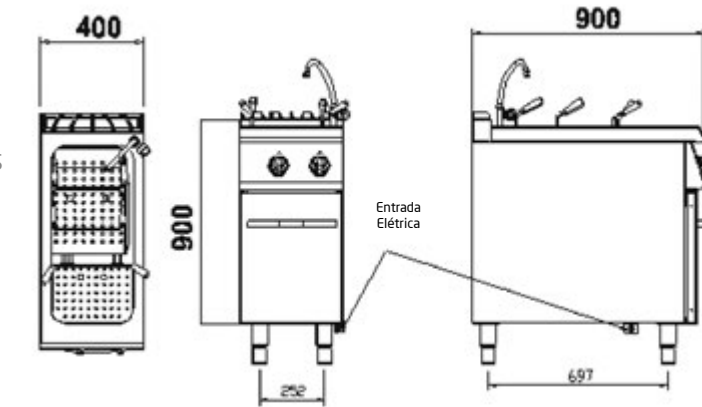

**Simples**  
Simple  
Simples  
Single

COZEDORES DE PASTA ELÉTRICOS  
CUISEURS A PATES ELECTRIQUES  
COCEDORES DE PASTA ELÉTRICOS  
ELECTRIC PASTA COOKERS  
**UDCP9DAPE**  
5900.060

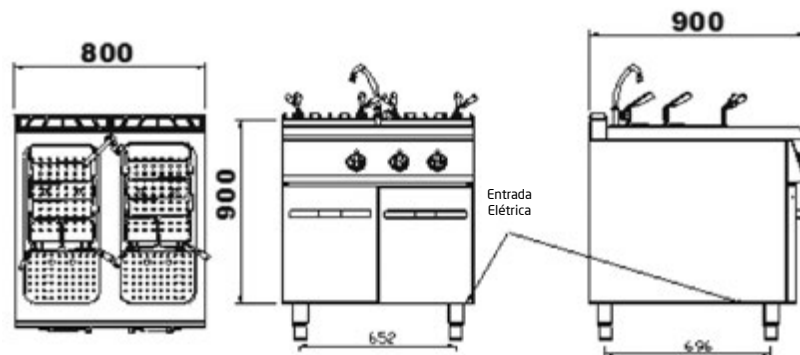

**Duplo**  
Double  
Doble  
Double





Cook HIT  
900

### COOK HIT 900 - DESENHOS TÉCNICOS

COOK HIT 900 - DESSINS TECHNIQUES

COOK HIT 900 - DIBUJOS TÉCNICOS

COOK HIT 900 - TECHNICAL DRAWINGS



COZEDORES DE PASTA GÁS  
CUISEURS A PATES GAS  
COCEDORES DE PASTA GAS  
GAS PASTA COOKERS

**UDCP9SAPG**

**5900.082**

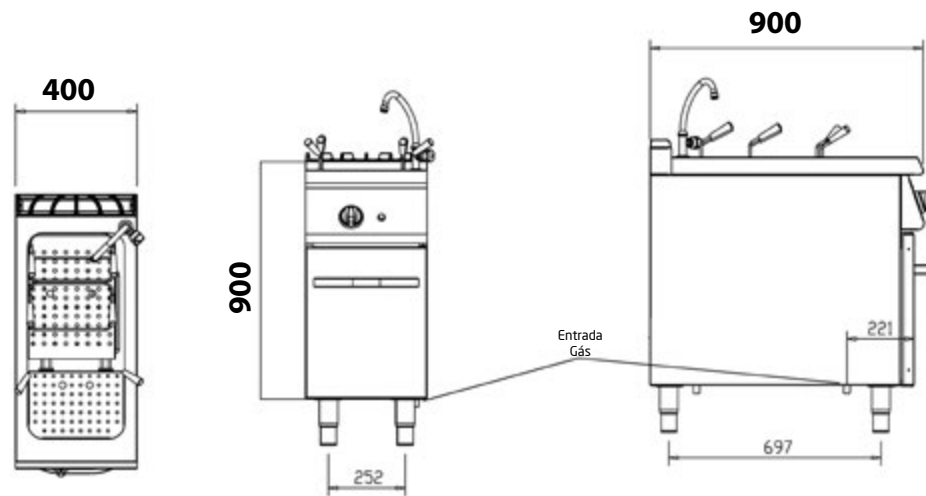

FRITADEIRAS BASCULANTES A GÁS  
FRITEUSE BASCULANT GAZ  
FREIDORAS BASCULANTES GAS  
GAS TILTING FRYERS

**UDFB980G**

**5900.064**

**80 L**

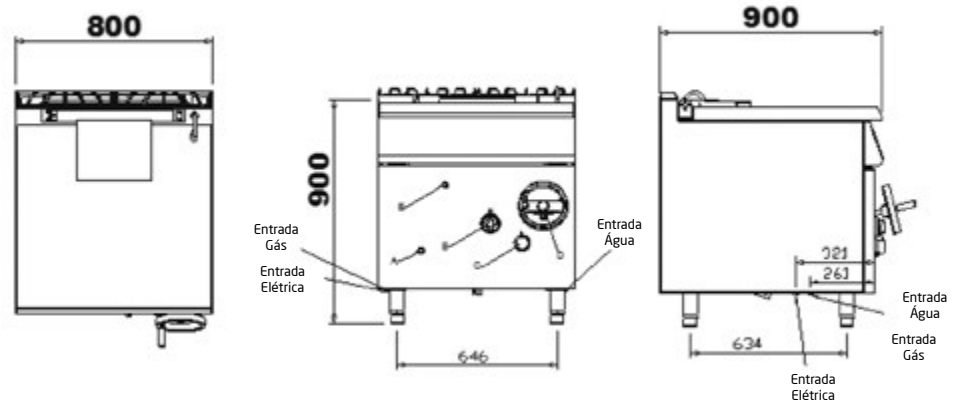

FRITADEIRAS BASCULANTES A GÁS  
FRITEUSE BASCULANT GAZ  
FREIDORAS BASCULANTES GAS  
GAS TILTING FRYERS

**UDFB9120G**

**5900.062**

**120 L**

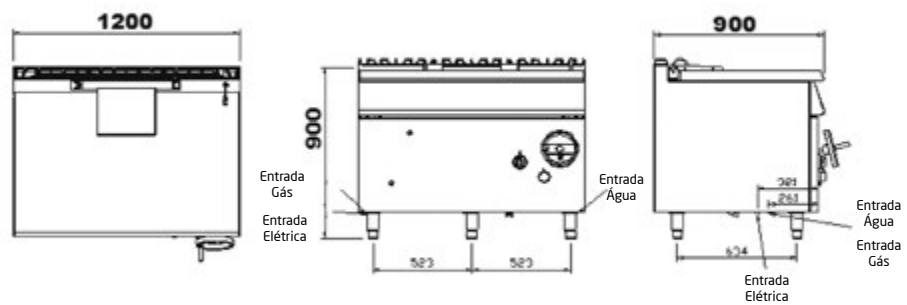

FRITADEIRA BASCULANTE ELÉTRICA  
FRITEUSE BASCULANT ÉLECTRIQUE  
FREIDORAS BASCULANTES ELÉCTRICAS  
ELECTRIC TILTING FRY

**UDFB980E**

5900.068

80 L

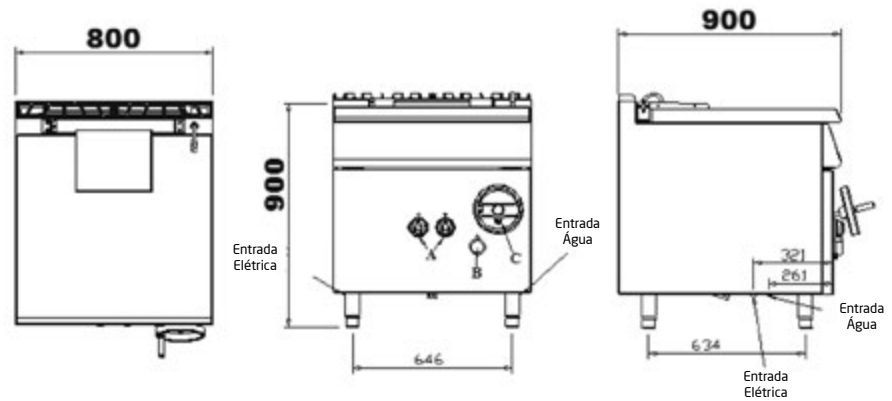

a) On - Off + Termostato  
b) Torneira de água  
c) Braço de elevação

a) On - Off + Thermostat  
b) Robinet d'eau  
c) Bras de levage

a) On - Off + Thermostat  
b) Grifo de agua  
c) Brazo de elevación

a) On - Off + Thermostat  
b) Water tap  
c) Lift arm

FRITADEIRA BASCULANTE ELÉTRICA  
FRITEUSE BASCULANT ÉLECTRIQUE  
FREIDORAS BASCULANTES ELÉCTRICAS  
ELECTRIC TILTING FRY

**UDFB9120E**

5900.069

120 L

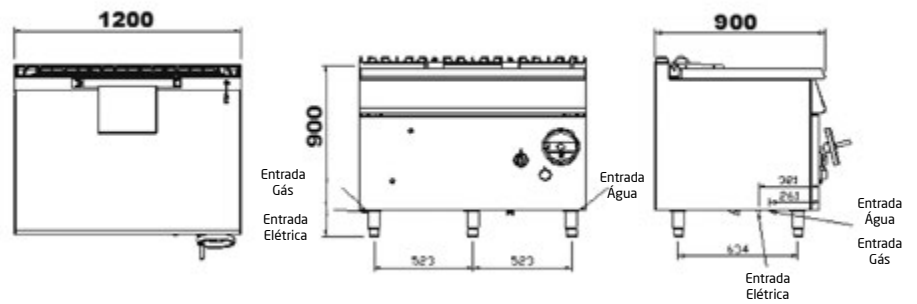

MARMITAS A GÁS  
MARMITES GAZ  
MARMITAS GAS  
GAS BOILING PANS

**UDM9150IG**

5900.070

150 L

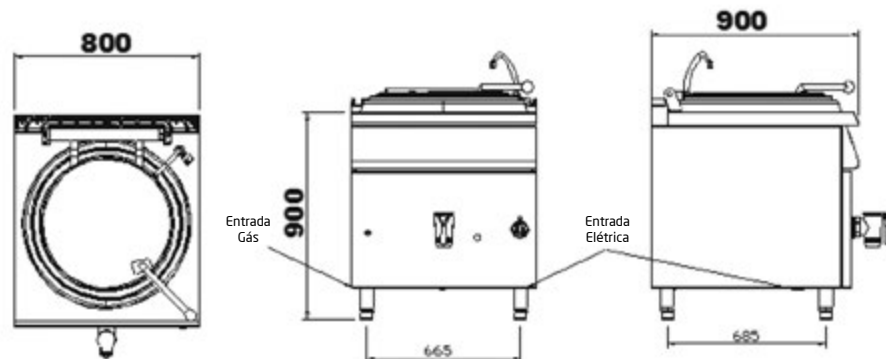



UDI

Cook HIT  
900

**COOK HIT 900 - DESENHOS TÉCNICOS**

COOK HIT 900 - DESSINS TECHNIQUES

COOK HIT 900 - DIBUJOS TÉCNICOS

COOK HIT 900 - TECHNICAL DRAWINGS



MARMITAS ELÉTRICAS  
MARMITES ÉLECTRIQUE  
MARMITAS ELÉCTRICAS  
ELECTRIC BOILING PANS

**UDM9150IE**

5900.072

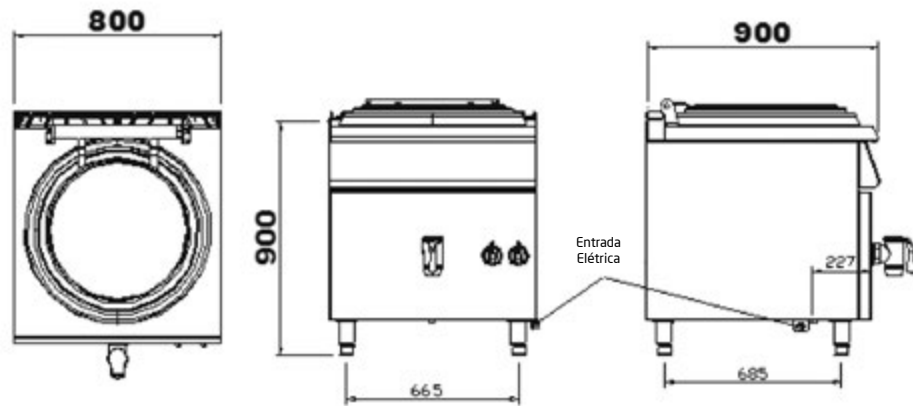

MARMITAS A GÁS  
MARMITES GAZ  
MARMITAS GAS  
GAS BOILING PANS

**UDM9250IG**

5900.074

250 L

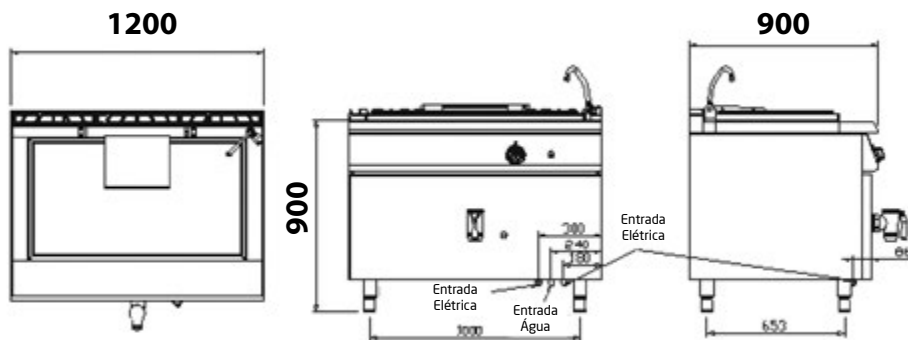

MARMITAS ELÉTRICAS  
MARMITES ÉLECTRIQUE  
MARMITAS ELÉCTRICAS  
ELECTRIC BOILING PANS

**UDM9250IE**

5900.076

250 L

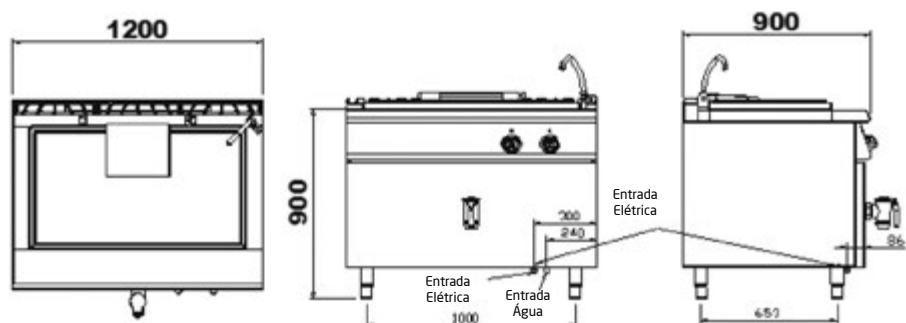



AQUECEDOR DE BATATA FRITA  
CHAUFFE POMME DE TERRE  
CALENTADOR DE PATATA FRITA  
FRYED CHIP WARMER

**UDABF9APE**

**5900.084**

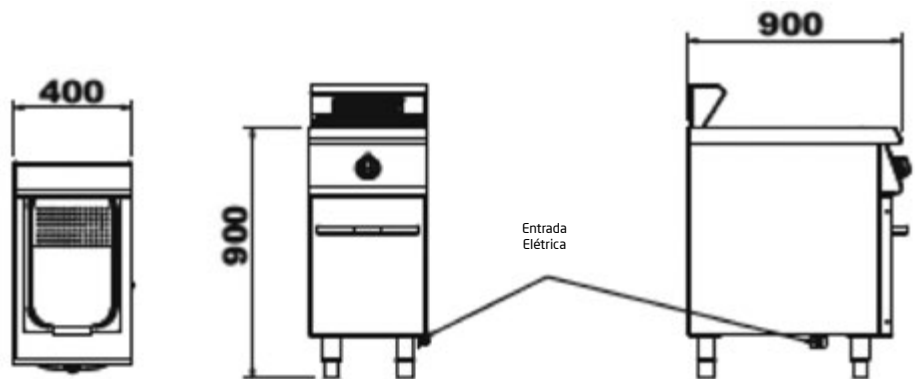



OPCIONAIS

OPTIONNELS

OPCIONALES

OPCIONALS

 Modelo / Modèle / Modelo / Model  
**TABULEIRO P/ FORNO UDI**

 PLATEAU P/FOUR UDI  
BANDEJA P/HORNO UDI  
TRAY F/OVEN UDI

Código / Code / Código / Code

**5900.100**
**158,00€**

 Dimensões / Dimensions / Dimensiones  
**GN2/1 - 530X650X65**

 Modelo / Modèle / Modelo / Model  
**GRELHA P/ FOGÃO**

 GRILLES P/CUISINIÈRES  
REJILLAS P/COCINAS  
GRILLS F/GAS RANGE

Código / Code / Código / Code

**5900.102**
**106,00€**

 Dimensões / Dimensions / Dimensiones  
**290X395**

 Modelo / Modèle / Modelo / Model  
**CHAMINÉ P/ EXTRAÇÃO DE FUMO**

 CHEMINÉE P/ EXTRACTION FUMÉE  
CHIMENEA P/ EXTRACCIÓN DE HUMO  
FLUE F/ SMOKE EXTRACTION

Código / Code / Código / Code

**5900.104**
**32,00€**

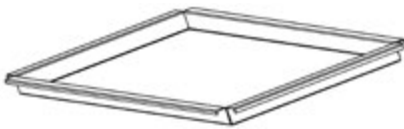
 Dimensões / Dimensions / Dimensiones  
**400X70**

 Modelo / Modèle / Modelo / Model  
**TABULEIRO P/ MAXIFORNO**

 PLATEAU P/MAXIFORNO  
BANDEJA P/MAXIFORNO  
TRAY F/MAXIFORNO

Código / Code / Código / Code

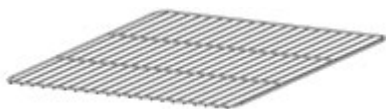
**5900.106**
**118,00€**

 Dimensões / Dimensions / Dimensiones  
**935X640**

 Modelo / Modèle / Modelo / Model  
**GRELHA P/ MAXIFORNO**

 GRILLES P/MAXIFORNO  
REJILLAS P/MAXIFORNO  
GRILLS F/MAXIFORNO

Código / Code / Código / Code

**5700.098**
**114,00€**

 Dimensões / Dimensions / Dimensiones  
**935X590**

 Modelo / Modèle / Modelo / Model  
**GRELHA P/ FORNO GN2/1**

 GRILLES P/FOUR  
REJILLAS P/HORNO  
GRILLS F/OVEN UDI

Código / Code / Código / Code

**5900.110**
**57,00€**

 Dimensões / Dimensions / Dimensiones  
**535 X590**



UDI

Cook HIT  
900

**ACESSÓRIOS E OPCIONAIS - COOK HIT 900**

ACCESSOIRES ET OPTIONNELS - COOK HIT 900

ACCESORIOS Y OPCIONALES - COOK HIT 900

OPCIONALS AND SPARE PARTS - COOK HIT 900

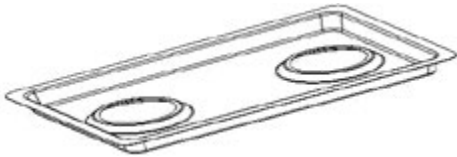

Modelo / Modèle / Modelo / Model  
**TABULEIRO DE RECOLHA DE RESIDUOS**

PLATEAU  
BANDEJA  
TRAY

Dimensões / Dimensions / Dimensiones  
**524X338X30**

Código / Code / Código / Code  
**5900.112**  
**298,00€**



Modelo / Modèle / Modelo / Model  
**CESTO P/ FRITADEIRA 24LTS ELECTRICA**

PANIER P/ FRITEUSES 24LTS ELECTRIQUES  
CESTAP/ FREIDORAS 24LTS ELÉCTRICAS  
BASKET F/ FRYERS 24LTS ELECTRIC

Dimensões / Dimensions / Dimensiones  
**140x320x185**

Código / Code / Código / Code  
**5900.113**  
**81,00€**



Modelo / Modèle / Modelo / Model  
**CESTO P/ FRITADEIRA 24LTS GÁS**

PANIER P/ FRITEUSES 24LTS GAZ  
CESTAP/ FREIDORAS 24LTS GAS  
BASKET F/ FRYERS 24LTS GAS

Dimensões / Dimensions / Dimensiones  
**350x280x130**

Código / Code / Código / Code  
**5900.116**  
**108,00€**



Modelo / Modèle / Modelo / Model  
**CESTO P/ FRITADEIRA 24LTS GÁS**

PANIER P/ FRITEUSES 24LTS GAZ  
CESTAP/ FREIDORAS 24LTS GAS  
BASKET F/ FRYERS 24LTS GAS

Dimensões / Dimensions / Dimensiones  
**140x350x130**

Código / Code / Código / Code  
**5900.117**  
**90,00€**



Modelo / Modèle / Modelo / Model  
**CESTO P/ COZE PASTA SIMPLES ELECTRICO**

PANIER P/ CUISEURS A PATES SIMPLE ELECTRIQUES  
CESTAP/ COCEDORES DE PASTA SIMPLES ELÉCTRICAS  
BASKET F/ PASTA COOKERS SINGLE ELECTRIC

Dimensões / Dimensions / Dimensiones  
**270x145x150**

Código / Code / Código / Code  
**5900.118**  
**251,00€**



Modelo / Modèle / Modelo / Model  
**CESTO PEQUENO P/ COZE PASTA SIMPLES ELE**

PANIER P/ CUISEURS A PATES SIMPLE ELECTRIQUES  
CESTAP/ COCEDORES DE PASTA SIMPLES ELÉCTRICAS  
BASKET F/ PASTA COOKERS SINGLE ELECTRIC

Dimensões / Dimensions / Dimensiones  
**135x135x180**

Código / Code / Código / Code  
**5900.120**  
**164,00€**



Modelo / Modèle / Modelo / Model  
**CESTO P/ COZE PASTA SIMPLES GAS**  
 PANIER P/ CUISEURS A PATES SIMPLE GAZ  
 CESTAP/ COCEDORES DE PASTA SIMPLES GAS  
 BASKET F/ PASTA COOKERS SINGLE GAS

Código / Code / Código / Code  
**5900.122**  
**150,00€**

Dimensões / Dimensions / Dimensiones  
**237x160x255**



Modelo / Modèle / Modelo / Model  
**CESTO PEQUENO P/ COZE PASTA SIMPLES GAS**  
 PANIER P/ CUISEURS A PATES SIMPLE GAZ  
 CESTAP/ COCEDORES DE PASTA SIMPLES GAS  
 BASKET F/ PASTA COOKERS SINGLE GAS

Código / Code / Código / Code  
**5900.124**  
**117,00€**

Dimensões / Dimensions / Dimensiones  
**115x160x255**



Modelo / Modèle / Modelo / Model  
**TRAVESSÃO P/ BANHO MARIA**  
 TRAVERSE BAIN-MARIE  
 TRAVESSA BAÑOS MARÍA  
 CROSSMEMBER BAIN-MARIES

Código / Code / Código / Code  
**5900.128**  
**29,00€**

Dimensões / Dimensions / Dimensiones  
**719X24X11**



Modelo / Modèle / Modelo / Model  
**TRAVESSÃO P/ BANHO MARIA**  
 TRAVERSE BAIN-MARIE  
 TRAVESSA BAÑOS MARÍA  
 CROSSMEMBER BAIN-MARIES

Código / Code / Código / Code  
**5900.130**  
**29,00€**

Dimensões / Dimensions / Dimensiones  
**329X24X11**

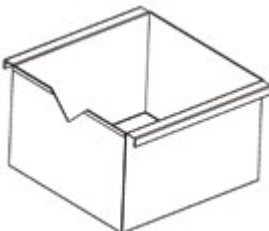

Modelo / Modèle / Modelo / Model  
**CUBA DE RECUPERADOR DE ÓLEO**  
 BAC RÉCUPÉRATION HUILE  
 CUBA DE RECUPERADOR DEACEITE  
 OIL DRAIN-OFF PAN

Código / Code / Código / Code  
**5900.132**  
**143,00€**

Dimensões / Dimensions / Dimensiones  
**250X520X200**

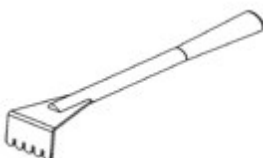

Modelo / Modèle / Modelo / Model  
**RASPADOR**  
 RACLETTE  
 RASPADOR  
 SCRAPER

Código / Code / Código / Code  
**5900.134**  
**120,00€**

Modelo / Modèle / Modelo / Model  
**GRELHA REDUTORA**  
 GRILLE DE RÉDUCTION  
 REDUCCIÓIN DE REJILLA  
 REDUCING GRID

Código / Code / Código / Code  
**5900.136**  
**46,00€**





**PAINEL ELETROMECÂNICO**  
**CONTRÔLE ÉLECTROMÉCANIQUE**  
**CONTROL ELECTROMECHANICO**  
**ELECTROMECHANICAL CONTROLS**

**MÉTODOS DE COZINHAR**

- Cozimento manual com três modos de cozimento: Convecção de 50 ° C a 260 ° C, Vapor de 50 ° C a 130 ° C, Combinado de 50 ° C a 260 ° C.

**OPERAÇÃO**

- Painel de Controlo com comutador manual e luzes de Controlo do modo de operação.

**MECANISMOS DE CONTROLO**

- Autoreverse (inversão automática da direção do ventilador) para um cozimento perfeitamente uniforme.
- Ventilação manual da câmara.
- Iluminação LED da câmara de cozedura.

**CARACTERÍSTICAS TÉCNICAS DE CONSTRUÇÃO**

- Câmara de cozedura estanque à água perfeitamente lisa com extremidades arredondadas.
- Porta de vidro duplo com vidro temperado termorefletivo, com cavidade de ar para evitar a irradiação de calor para os usuários e para maior eficiência.
- Vidro interno com abertura para livro para facilitar a limpeza.
- Pega de abertura esquerda ou direita.
- Dobradiças ajustáveis para melhor aderência.
- Defletor extraível para facilitar a limpeza da baía do ventilador.
- Proteção IPX3 contra jato de água (ICON).
- Proteção IPX4 contra jato de água (ICON51).

**LIMPEZA, MANUTENÇÃO REGULAR**

- Sistema de limpeza manual com chuveiro de mão externo (chuveiro opcional).

**MÉTODOS DE COCINA**

- Cocción manual con tres modos de cocción: Convección de 50 ° C a 260 ° C, Vapor de 50 ° C a 130 ° C, Combinado de 50 ° C a 260 ° C.

**OPERACIÓN**

- Panel de control con apartamento manual y luces de control del modo de operación.

**MECANISMOS DE CONTROL**

- Autoreverse (inversión automática del sentido del ventilador) para una cocción perfectamente uniforme.
- Ventilación manual de la cámara.
- Iluminación LED de la cámara de cocción.

**CARACTERÍSTICAS TÉCNICAS DE CONSTRUCCIÓN**

- Cámara de cocción perfectamente lisa y estanca con bordes redondeados.
- Puerta de doble acristalamiento con vidrio templado termoreflectante, con cámara de aire para evitar la radiación de calor hacia los usuarios y para una mayor eficiencia.
- Vidrio interno con apertura para libros para facilitar la limpieza.
- Asa de apertura a derecha o izquierda.
- Bisagras ajustables para un agarre óptimo.
- Deflector extraíble para facilitar la limpieza del compartimento del ventilador.
- Protección contra chorros de agua IPX3 (ICON).
- Protección contra chorros de agua IPX4 (ICON51).

**LIMPIEZA, MANTENIMIENTO REGULAR**

- Sistema de limpieza manual con ducha de mano externa (ducha opcional).

**MÉTHODES DE CUISSON**

- Cuisson manuelle avec trois modes de cuisson: Convection de 50 ° C à 260 ° C, Vapeur de 50 ° C à 130 ° C, Combinée de 50 ° C à 260 ° C

**OPÉRATION**

- Panneau de commande avec appareillage manuel et voyants de contrôle du mode de fonctionnement.

**MÉCANISMES DE CONTRÔLE**

- Autoreverse (inversion automatique du sens du ventilateur) pour une cuisson parfaitement homogène.
- Purge manuelle de la chambre.
- Éclairage de la chambre de cuisson à LED.

**CARACTÉRISTIQUES TECHNIQUES DE CONSTRUCTION**

- Chambre de cuisson parfaitement lisse et étanche aux bords arrondis.
- Porte à double vitrage avec verre trempé thermoréfléchissant, avec une cavité d'air pour empêcher le rayonnement thermique vers les utilisateurs et pour une efficacité accrue.
- Verre interne avec ouverture de livre pour faciliter le nettoyage.
- Poignée d'ouverture gauche ou droite.
- Charnières réglables pour une adhérence optimale.
- Déflecteur extractible pour faciliter le nettoyage de la baie de ventilation.
- Protection contre les jets d'eau IPX3 (ICON).
- Protection contre les jets d'eau IPX4 (ICON51).

**NETTOYAGE, ENTRETIEN RÉGULIER**

- Système de nettoyage manuel avec douchette externe (douche en option).

**COOKING METHODS**

- Manual cooking with three cooking modes: Convection from 50°C to 260°C, Steam from 50°C to 130°C, Combined from 50°C to 260°C.

**OPERATION**

- Control panel with manual switchgear and operation mode control lights.

**CONTROL MECHANISMS**

- Autoreverse (automatic inversion of the direction of the fan) for perfectly uniform cooking.
- Manual chamber venting.
- LED cooking chamber lighting.

**TECHNICAL BUILD CHARACTERISTICS**

- Perfectly smooth watertight cooking chamber with rounded edges.
- Double-glazed door with thermoreflexive tempered glass, with an air cavity to prevent heat radiation towards users and for increased efficiency.
- Internal glass with book opening for ease of cleaning.
- Left or right-hand opening handle.
- Adjustable hinges for optimal grip.
- Extractable deflector for ease of cleaning of the fan bay.
- IPX3 water jet protection (ICON).
- IPX4 water jet protection (ICON51).

**CLEANING, REGULAR MAINTENANCE**

- Manual cleaning system with external hand shower (shower optional).



UDI



sob pedido  
sur demande  
a pedido  
on request

## FORNOS ELETROMECÂNICOS VAPOR DIRETO GN1/1 - 600x400

FOURS COMBI COMPACTES - ÉLECTROMECHANIQUE GN1/1 - 600x400

HORNOS COMBI COMPACTOS - ELETROMECHANICOS GN1/1 - 600x400

COMPACT COMBI OVENS - ELECTROMECHANIC GN1/1 - 600x400



MODELO / MODÈLE / MODELO / MODEL CÓDIGO / CODE / CÓDIGO / CODE		ICEM051E 4001.060	ICGM051E 4001.068
<b>Preço / Prix / Precio / Price</b>	€	<b>5.050,00</b>	<b>7.570,00</b>
Dimensões / Dimensions / Dimensiones	mm	777x729x777	777x729x777
Capacidade câmara /Chambre capac. /Capaci. camara /Chamber capaci.	nr	5x 1/1 GN 5x600x400	5x 1/1 GN 5x600x400
Espaço entre as prateleiras / Espace entre étagères / Espado entre las estanterías / Space between shelves	mm	70	70
Potência Térmica Nominal / Puissance Thermique Nominale / Potencia Térmica Nominal / Nominal Thermal Power	kW/kcal	-/-	8,5/7310
Potência / Puissance / Potência / Power	Qn/kW	-/7,25	-/0,25
Peso Líquido-Bruto / Poids Net-Brut / Peso Neto-Bruto / Net-Gross Weight	kg	74/85	80/91
Tensão / Tension / Tension / Tension	V	400	230



MODELO / MODÈLE / MODELO / MODEL CÓDIGO / CODE / CÓDIGO / CODE		ICEM071E 4001.076	ICGM071E 4001.084
<b>Preço / Prix / Precio / Price</b>	€	<b>6.624,00</b>	<b>9.132,00</b>
Dimensões / Dimensions / Dimensiones	mm	777x729x942	777x729x942
Capacidade câmara /Chambre capac. /Capaci. camara /Chamber capaci.	nr	7x 1/1 GN 7x600x400	7x 1/1 GN 7x600x400
Espaço entre as prateleiras / Espace entre étagères / Espado entre las estanterías / Space between shelves	mm	70	70
Potência Térmica Nominal / Puissance Thermique Nominale / Potencia Térmica Nominal / Nominal Thermal Power	Qn/kW	-/-	12/10320
Potência / Puissance / Potência / Power	Qn/kW	-/12,5	-/0,5
Peso Líquido-Bruto / Poids Net-Brut / Peso Neto-Bruto / Net-Gross Weight	kg	90/102	97/109
Tensão / Tension / Tension / Tension	V	400	230



MODELO / MODÈLE / MODELO / MODEL CÓDIGO / CODE / CÓDIGO / CODE		ICEM101E 4001.092	ICGM101E 4001.100
<b>Preço / Prix / Precio / Price</b>	€	<b>7.607,00</b>	<b>10.509,00</b>
Dimensões / Dimensions / Dimensiones	mm	777x729x1152	777x729x1152
Capacidade câmara /Chambre capac. /Capaci. camara /Chamber capaci.	nr	10X 1/1 GN 10x600x400	10X 1/1 GN 10x600x400
Espaço entre as prateleiras / Espace entre étagères / Espado entre las estanterías / Space between shelves	mm	70	70
Potência Térmica Nominal / Puissance Thermique Nominale / Potencia Térmica Nominal / Nominal Thermal Power	kW/kcal	-/-	16/13760
Potência / Puissance / Potência / Power	Qn/kW	-/14,5	-/0,5
Peso Líquido-Bruto / Poids Net-Brut / Peso Neto-Bruto / Net-Gross Weight	kg	104/117	111/124
Tensão / Tension / Tension / Tension	V	400	230

Recomenda-se a ligação a depurador nos fornos a vapor

Le raccordement à l'épurateur dans les fours à vapeur est recommandé

Se recomienda la conexión al depurador en hornos de vapor

Connection to scrubber in steam ovens is recommended



OPCIONAIS ICEM-ICET-ICGM-ICGT / OPTIONNELLES ICEM-ICET-ICGM-ICGT / OPCIONALES ICEM-ICET-ICGM-ICGT / ICEM-ICET-ICGM-ICGT OPTIONALS 257



**PAINEL ELETROMECÂNICO**  
**CONTRÔLE ÉLECTROMÉCANIQUE**  
**CONTROL ELECTROMECHANICO**  
**ELECTROMECHANICAL CONTROLS**



MODELO / MODÈLE / MODELO / MODEL	ICCM026E	ICCM061E
CÓDIGO / CODE / CÓDIGO / CODE	4001.118	4001.120
<b>Preço / Prix / Precio / Price</b>	<b>€ 6.697,00</b>	<b>7.410,00</b>
Dimensões / Dimensions / Dimensiones	mm 510x625x880	510x800x880
Capacidade câmara /Chambre capac. /Capaci. camara /Chamber capaci.	nr 6X 2/3 GN	6X 1/1 GN
Espaço entre as prateleiras / Espace entre étagères / Espado entre las estanterías / Space between shelves	mm 60	60
Potência / Puissance / Potência / Power	Qn/kW -/5,25	-/7,75
Peso Líquido-Bruto / Poids Net-Brut / Peso Neto-Bruto / Net-Gross Weight	kg 59/68	73/82
Tensão / Tension / Tension / Tension	V 400	400



**PAINEL DE CONTROLO ELETRÓNICO**  
**COMANDES DE CONTROL ELECTRÓNICO**  
**COMMANDES DE CONTRÔLE ÉLECTRONIQUE**  
**ELECTRONIC CONTROL PANEL**



MODELO / MODÈLE / MODELO / MODEL	ICCT026E	ICCT061E
CÓDIGO / CODE / CÓDIGO / CODE	4001.122	4001.124
<b>Preço / Prix / Precio / Price</b>	<b>€ 7.583,00</b>	<b>8.455,00</b>
Dimensões / Dimensions / Dimensiones	mm 510x625x880	510x800x880
Capacidade câmara /Chambre capac. /Capaci. camara /Chamber capaci.	nr 6X 2/3 GN	6X 1/1 GN
Espaço entre as prateleiras / Espace entre étagères / Espado entre las estanterías / Space between shelves	mm 60	60
Potência / Puissance / Potência / Power	Qn/kW -/5,25	-/7,75
Peso Líquido-Bruto / Poids Net-Brut / Peso Neto-Bruto / Net-Gross Weight	kg 59/68	73/82
Tensão / Tension / Tension / Tension	V 400	400

Recomenda-se a ligação a depurador nos fornos a vapor  
 Le raccordement à l'épurateur dans les fours à vapeur est recommandé  
 Se recomienda la conexión al depurador en hornos de vapor  
 Connection to scrubber in steam ovens is recommended



UDI

## FORNOS COMBINADOS - MECÂNICOS

FOURS COMBI - MÉCANIQUES

HORNOS COMBI - MECÁNICO

COMBI OVENS - MECHANICAL



### VAPOR DIRETO | VAPEUR DIRECT | VAPOR DIRECTO | DIRECT STEAM



Painel de comando eletromecânico com indicadores de controlo de funcionamento; Sistema de lavagem manual com grupo chuveiro externo (opcional); Sistema Autoreverse (Inversão automática do sentido da rotação do ventilador); Ventilação manual da câmara Iluminação interna LED.



Électromécanique panneau de commande avec des indicateurs de contrôle de fonctionnement; Système de lavage manuel avec le groupe externe- de douche en option; Système Autoreverse (inversion automatique du sens de rotation du ventilateur); Ventilation manuelle de la chambre . LED éclairage intérieur.



Panel de control electromecánico con indicadores de control de funcionamiento; Sistema de lavado manual con ducha grupo externo opcional ; Sistema de Autoreverse (inversión automática del sentido de rotación del ventilador); Cámara de ventilación manual LED de iluminación interior.



Electromechanical control panel with operating control indicators; Manual washing system with outdoor shower group - optional; Autoreverse system (automatic reversal of direction of fan rotation); Manual ventilation chamber LED indoor lighting.



confirmar disponibilidade dos produtos desta página  
confirmer la disponibilité des produits sur cette page  
confirmar la disponibilidad de los productos de esta página  
confirm the availability of the products on this page

### PAINEL ELETROMECÂNICO CONTRÔLE ÉLECTROMÉCANIQUE CONTROL ELECTROMECHANICO ELECTROMECHANICAL CONTROLS

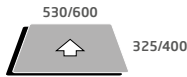

MODELO / MODÈLE / MODELO / MODEL	ICGM 051
CÓDIGO / CODE / CÓDIGO / CODE	4001.016
<b>Preço / Prix / Precio / Price</b>	€ <b>6.868,00</b>
Dimensões / Dimensions / Dimensiones	mm 812x725x770
Capacidade da câmara / Chambre capacite / Capacidad cámara / Chamber capacity	Gn`s 5x 1/1 GN
Espaço entre as prateleiras / Espace entre étagères / Espacio entre las estanterías / Space between shelves	mm 70
Potência Térmica Nominal/ Puissance Thermique Nominale/ Nominal Thermal Power	kW/ Kcal 8,5/7310
Potência Total / Puissance Total / Potencia Total / Total Power	kW 0,25
Peso Líquido-Bruto / Poids Net-Brut / Peso Neto-Bruto / Net-Gross Weight	Kg 80/91
Tensão / Tension / Tensión / Tension	V 230

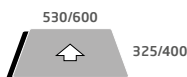

MODELO / MODÈLE / MODELO / MODEL	ICEM 071
CÓDIGO / CODE / CÓDIGO / CODE	4001.020
<b>Preço / Prix / Precio / Price</b>	€ <b>6.046,00</b>
Dimensões / Dimensions / Dimensiones	mm 812X725X935
Capacidade da câmara / Chambre capacite / Capacidad cámara / Chamber capacity	Gn`s 7X 1/1 GN
Espaço entre as prateleiras / Espace entre étagères / Espacio entre las estanterías / Space between shelves	mm 70
Potência Térmica Nominal/ Puissance Thermique Nominale/ Nominal Thermal Power	kW/ Kcal N/A
Potência Total / Puissance Total / Potencia Total / Total Power	kW 12,5
Peso Líquido-Bruto / Poids Net-Brut / Peso Neto-Bruto / Net-Gross Weight	Kg 90/102
Tensão / Tension / Tensión / Tension	V 400

Recomenda-se a ligação a depurador nos fornos a vapor  
Le raccordement à l'épurateur dans les fours à vapeur est recommandé  
Se recomienda la conexión al depurador en hornos de vapor  
Connection to scrubber in steam ovens is recommended



OPCIONAIS ICEM-ICET-ICGM-ICGT / OPTIONNELLES ICEM-ICET-ICGM-ICGT / OPCIONALES ICEM-ICET-ICGM-ICGT / ICEM-ICET-ICGM-ICGT OPTIONALS 257



## PAINEL DE CONTROLO ELETRÓNICO COMANDOS DE CONTROL ELECTRÓNICO COMMANDES DE CONTRÔLE ÉLECTRONIQUE ELECTRONIC CONTROL COMMANDS



### MODOS DE COZINHA

- Programável com capacidade para armazenar 99 programas de cozimento em sequência automática (até 9 ciclos), atribuindo um nome e ícone dedicado.
- Cozedura manual com três modos de cozedura e início imediato da cozedura: convecção de 30 °C a 260 °C, vapor de 30 °C a 130 °C, combinação convecção + vapor de 30 °C a 260 °C.

### OPERAÇÃO

- LED HVS High Visibility System) display alfanumérico para exibir as temperaturas, clima, tempo e temperatura ao centro do produto.
- Visor colorido de 2,4 polegadas (LCD - TFT) para exibir seus programas favoritos, programas predefinidos, ventilador, lavagem automática, menus e configurações.

### MECANISMOS DE CONTROL

- Controle automático de ventilação da câmara.
- Conexão USB para baixar dados HACCP, atualizar software e carregar / baixar programas de cozinha.
- Iluminação LED da câmara de cozedura.
- EcoSpeed - Com base na quantidade e tipo de produto, o forno otimiza e controla o consumo de energia, mantendo a melhor temperatura de cozimento evitando oscilações.
- EcoVapor - Com o sistema EcoVapor, há uma redução líquida no consumo de água e energia devido aos controles automáticos da saturação do vapor na câmara de cozedura.

### CARACTERÍSTICAS TÉCNICAS DE CONSTRUÇÃO

- Câmara de cozedura estanque à água perfeitamente lisa com extremidades arredondadas.
- Porta com vidro duplo temperado com câmara de ar e vidro refletor interno para menor irradiação de calor para o operador e maior eficiência.
- Vidro interno que se abre para facilitar a limpeza.
- Defletor que pode ser aberto para facilitar a limpeza do compartimento do ventilador.



### MODOS DE COCCIÓN

- Programable con capacidad de almacenar 99 programas de cocción en secuencia automática (hasta 9 ciclos), asignándole un nombre e icono dedicado.
- Cocción manual con tres modos de cocción e inicio de cocción instantánea: convección de 30 °C a 260 °C, vapor de 30 °C a 130 °C, combinación de convección + vapor de 30 °C a 260 °C.

### OPERACIÓN

- LED HVS High Visibility System) Display alfanumérico para visualizar las temperaturas, Clima, tiempo y temperatura central del producto.
- Pantalla a color de 2.4 pulgadas (LCD - TFT) para mostrar sus programas favoritos, programas preestablecidos, ventilador, lavado automático, menús y configuraciones.

### MECANISMOS DE CONTROL

- Control automático de ventilación de la cámara.
- Conexión USB para descargar datos HACCP, actualizar software y cargar / descargar programas de cocción.
- Iluminación LED de la cámara de cocción.
- EcoSpeed - Basado en la cantidad y tipo de producto, el horno optimiza y controla la salida de energía, manteniendo la mejor temperatura de cocción y evitando fluctuaciones.
- EcoVapor - Con el sistema EcoVapor, hay una reducción neta en el consumo de agua y energía debido a los controles automáticos de la saturación de vapor en la cámara de cocción.

### CARACTERÍSTICAS TÉCNICAS DE CONSTRUCCIÓN

- Cámara de cocción perfectamente lisa y estanca con bordes redondeados.
- Puerta con doble vidrio templado con cámara de aire y vidrio interior reflectante de calor para menor radiación térmica hacia el operador y mayor eficiencia.
- Vidrio interno que se abre para facilitar la limpieza.
- Deflector que se puede abrir para facilitar la limpieza del compartimento del ventilador.



### MODES DE CUISSON

- Programmable avec la possibilité de stocker 99 programmes de cuisson en séquence automatique (jusqu'à 9 cycles), en attribuant un nom et une icône dédiée.
- Cuisson manuelle avec trois modes de cuisson et démarrage instantané de la cuisson: convection de 30 °C à 260 °C, vapeur de 30 °C à 130 °C, combinaison convection + vapeur de 30 °C à 260 °C.

### OPÉRATION

- Affichage alphanumérique LED HVS High Visibility System) pour afficher les températures, le climat, le temps et la température à cœur.
- Écran couleur de 2,4 pouces (LCD - TFT) pour afficher vos programmes préférés, programmes pré-réglés, ventilateur, lavage automatique, menus et réglages.

### MÉCANISMES DE CONTRÔLE

- Contrôle automatique de la ventilation de la chambre.
- Connexion USB pour télécharger les données HACCP, mettre à jour le logiciel et charger / télécharger les programmes de cuisson.
- Éclairage de la chambre de cuisson à LED.
- EcoSpeed - En fonction de la quantité et du type de produit, le four optimise et contrôle la production d'énergie, en maintenant la meilleure température de cuisson et en évitant les fluctuations.
- EcoVapor - Avec le système EcoVapor, il y a une réduction nette de la consommation d'eau et d'énergie grâce aux commandes automatiques de la saturation de la vapeur dans la chambre de cuisson.

### CARACTÉRISTIQUES TECHNIQUES DE CONSTRUCTION

- Chambre de cuisson parfaitement lisse et étanche aux bords arrondis.
- Porte avec double verre trempé avec chambre à air et verre intérieur réfléchissant la chaleur pour moins de rayonnement thermique vers l'opérateur et une plus grande efficacité.
- Verre interne qui s'ouvre pour un nettoyage facile.
- Déflecteur qui peut être ouvert pour un nettoyage facile du compartiment du ventilateur.



### COOKING MODES

- Programmable with the ability to store 99 cooking programmes in automatic sequence (up to 9 cycles), assigning a name and dedicated icon.
- Manual cooking with three cooking modes and instant cooking start: convection from 30°C to 260°C, steam from 30°C to 130°C, combination convection + steam from 30°C to 260°C.

### OPERATION

- LED HVS High Visibility System) alphanumeric display to display the temperatures, Climate, time and core temperature.
- 2.4-inch (LCD - TFT) colour display for displaying your favourite programs, pre-set programs, fan, automatic washing, menus, and settings.

### CONTROL MECHANISMS

- Automatic chamber venting control.
- USB connection to download HACCP data, update software and load/ download cooking programmes.
- LED cooking chamber lighting.
- EcoSpeed - Based on the quantity and type of product, the oven optimises and controls the energy output, maintaining the best cooking temperature and avoiding fluctuations.
- EcoVapor - With the EcoVapor system, there is a net reduction in water and energy consumption due to the automatic controls of the steam saturation in the cooking chamber.

### TECHNICAL BUILD CHARACTERISTICS

- Perfectly smooth watertight cooking chamber with rounded edges.
- Door with double tempered glass with air chamber and interior heat-reflecting glass for less heat radiation towards the operator and greater efficiency.
- Internal glass that opens out for easy cleaning.
- Deflector that can be opened for easy fan compartment cleaning.



UDI



## FORNOS ELETRÓNICOS VAPOR DIRETO GN1/1 - 600x400

FOURS COMBI - ÉLECTRONIQUES GN1/1 - 600x400

HORNOS COMBI - ELECTRÓNICOS GN1/1 - 600x400

COMBI OVENS - ELECTRONIC GN1/1 - 600x400



MODELO / MODÈLE / MODELO / MODEL	ICET051E	ICGT051E
CÓDIGO / CODE / CÓDIGO / CODE	4001.064	4001.072
<b>Preço / Prix / Precio / Price</b>	<b>€ 6.304,00</b>	<b>8.664,00</b>
Dimensões / Dimensions / Dimensiones	mm 777x729x777	777x729x777
Capacidade câmara /Chambre capac. /Capaci. camara /Chamber capaci.	nr 5x 1/1 GN 5x600x400	5x 1/1 GN 5x600x400
Espaço entre as prateleiras / Espace entre étagères / Espado entre las estanterías / Space between shelves	mm 70	70
Potência Térmica Nominal / Puissance Thermique Nominale / Potencia Térmica Nominal / Nominal Thermal Power	kW/kcal -/-	8,5/7310
Potência / Puissance / Potência / Power	Qn/kW -/7,25	-/0,25
Peso Líquido-Bruto / Poids Net-Brut / Peso Neto-Bruto / Net-Gross Weight	kg 74/85	80/91
Tensão / Tension / Tension / Tension	V 400	230



MODELO / MODÈLE / MODELO / MODEL	ICET071E	ICGT071E
CÓDIGO / CODE / CÓDIGO / CODE	4001.080	4001.088
<b>Preço / Prix / Precio / Price</b>	<b>€ 8.037,00</b>	<b>10.054,00</b>
Dimensões / Dimensions / Dimensiones	mm 777x729x942	777x729x942
Capacidade câmara /Chambre capac. /Capaci. camara /Chamber capaci.	nr 7x 1/1 GN 7x600x400	7x 1/1 GN 7x600x400
Espaço entre as prateleiras / Espace entre étagères / Espado entre las estanterías / Space between shelves	mm 70	70
Potência Térmica Nominal / Puissance Thermique Nominale / Potencia Térmica Nominal / Nominal Thermal Power	Qn/kW -/-	12/10320
Potência / Puissance / Potência / Power	Qn/kW -/12,5	-/0,5
Peso Líquido-Bruto / Poids Net-Brut / Peso Neto-Bruto / Net-Gross Weight	kg 90/102	97/109
Tensão / Tension / Tension / Tension	V 400	230



MODELO / MODÈLE / MODELO / MODEL	ICET101E	ICGT101E
CÓDIGO / CODE / CÓDIGO / CODE	4001.096	4001.104
<b>Preço / Prix / Precio / Price</b>	<b>€ 9.046,00</b>	<b>12.021,00</b>
Dimensões / Dimensions / Dimensiones	mm 777x729x1152	777x729x1152
Capacidade câmara /Chambre capac. /Capaci. camara /Chamber capaci.	nr 10X 1/1 GN 10x600x400	10X 1/1 GN 10x600x400
Espaço entre as prateleiras / Espace entre étagères / Espado entre las estanterías / Space between shelves	mm 70	70
Potência Térmica Nominal / Puissance Thermique Nominale / Potencia Térmica Nominal / Nominal Thermal Power	kW/kcal -/-	16/13760
Potência / Puissance / Potência / Power	Qn/kW -/14,5	-/0,5
Peso Líquido-Bruto / Poids Net-Brut / Peso Neto-Bruto / Net-Gross Weight	kg 104/117	111/124
Tensão / Tension / Tension / Tension	V 400	230

Recomenda-se a ligação a depurador nos fornos a vapor  
 Le raccordement à l'épurateur dans les fours à vapeur est recommandé  
 Se recomienda la conexión al depurador en hornos de vapor  
 Connection to scrubber in steam ovens is recommended



OPCIONAIS ICET-ICGT-ICGM-ICGT / OPTIONNELLES ICET-ICGT-ICGM-ICGT / OPCIONALES ICET-ICGT-ICGM-ICGT / ICET-ICGT-ICGM-ICGT OPTIONALS 257

**VAPOR DIRETO | VAPEUR DIRECT | VAPOR DIRECTO | DIRECT STEAM**

Painel de comando eletrónico touch;  
 10 programas funcionamento: 10 modos de confeção pré-definidos disponíveis por ícones  
 Memória programável a partir de 11 a 89 em sequência automática (até 4 ciclos) com display led.  
 Iluminação interna led temporizada;  
 Sistema (clima) controle automático de humidade na câmara de cozedura, temperatura interna controlada por sonda(opcional);  
 Pré-aquecimento com programação automática;  
 Sistema automático ou manual de lavagem (opcional);  
 Atualização de software disponível por USB.



Panneau de commande électronique tactile;  
 10 programmes de fonctionnement: 10 modes de confection prédéfinis disponibles par des icônes de mémoire programmables de 11 à 89 en séquence automatique (jusqu'à 4 cycles) avec affichage LED. Éclairage LED interne chronométré;  
 Système (climat) contrôle automatique de l'humidité dans la chambre de cuisson, température interne contrôlée par sonde (en option);  
 Préchauffage avec programmation automatique;  
 Système de lavage automatique ou manuel (en option);  
 Mise à jour logicielle disponible par USB.



Panel de control electrónico táctil;  
 10 programas de funcionamiento: 10 modos de confección preestablecidos disponibles mediante iconos de memoria programables de 11 a 89 en secuencia automática (hasta 4 ciclos) con pantalla LED. Iluminación led interna cronometrada;  
 Sistema (clima) control automático de humedad en la cámara de cocción, temperatura interna controlada por sonda (opcional);  
 Precalentamiento con programación automática;  
 Sistema de lavado automático o manual (opcional);  
 Actualización de software disponible por USB.



Touch electronic control panel;  
 10 operating programs: 10 preset confection modes available by programmable memory icons from 11 to 89 in automatic sequence (up to 4 cycles) with LED display. Internal led lighting timed;  
 System (climate) automatic humidity control in the cooking chamber, internal temperature controlled by probe (optional);  
 Preheating with automatic programming;  
 Automatic or manual washing system (optional);  
 Software update available by USB.



**confirmar disponibilidade dos produtos desta página**  
 confirmer la disponibilité des produits sur cette page  
 confirmar la disponibilidad de los productos de esta página  
 confirm the availability of the products on this page

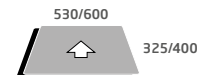

USB



MODELO / MODÈLE / MODELO / MODEL	ICET071	
CÓDIGO / CODE / CÓDIGO / CODE	4001.022	
<b>Preço / Prix / Precio / Price</b>	€	<b>7.073,00</b>
Dimensões / Dimensions / Dimensiones	mm	812x725x935
Capacidade câmara /Chambre capac. /Capaci. camera /Chamber capaci.	nr	7X1/1 GN
Espaço entre as prateleiras / Espace entre étagères / Espado entre las estanterías / Space between shelves	mm	70
Potência Térmica Nominal / Puissance Thermique Nominale / Potencia Térmica Nominal / Nominal Thermal Power	kW/kcal	12,5
Peso Líquido-Bruto / Poids Net-Brut / Peso Neto-Bruto / Net-Gross Weight	kg	90/102
Tensão / Tension / Tension / Tension	V	400

**Recomenda-se a ligação a depurador nos fornos a vapor**  
 Le raccordement à l'épurateur dans les fours à vapeur est recommandé  
 Se recomienda la conexión al depurador en hornos de vapor  
 Connection to scrubber in steam ovens is recommended

 elétrico  
 eléctrico  
 eléctrico  
 electric

 gás  
 gaz  
 gas  
 gas

OPCIONAIS ICEM-ICET-ICGM-ICGT / OPTIONNELLES ICEM-ICET-ICGM-ICGT / OPCIONALES ICEM-ICET-ICGM-ICGT / ICEM-ICET-ICGM-ICGT OPTIONALS 257





UDI







**FORNOS ICEM-ICET-ICGM-ICGT - ACESSÓRIOS E OPCIONAIS**

FOURS ICEM-ICET-ICGM-ICGT - ACCESSOIRES ET OPTIONNELS

HORNOS ICEM-ICET-ICGM-ICGT - ACCESORIOS Y OPCIONALES

OVENS ICEM-ICET-ICGM-ICGT - ACCESSORIES AND OPTIONALS



Cód.	Modelo	Obs.	€
	4001.408 SUPORTE INOX ISR071 P/ MODELOS: ICEM-ICET-ICGM-ICGT 071	810X700X790 mm	<b>884,00</b>
	4001.416 SUPORTE INOX ISR101 P/ MODELO: ICEM-ICET-ICGM-ICGT 101	810X700X615 mm	<b>884,00</b>
	4001.416A PORTA TABULEIROS INOX IPT811 8X1/1GN P/ SUPORTE: ISR101	8x1/1 GN - 45h entre espaços between guides	<b>445,00</b>
	4001.420 SONDA AO CORAÇÃO MULTUPOINT KISC04 P/ FORNO MODELO:S T: ICET-ICGT	Diâmetro 3 mm.	<b>423,00</b>
	4001.402 CHUVEIRO EXTERNO ICLD	Para / Pour / Para / For ICEM-ICET-ICGM-ICGT	<b>273,00</b>
	4001.404 HOTTE COM VENTILAÇÃO IKKV51 P/ MODELOS: ICEM-ICET-ICGM-ICGT 071	Para / Pour / Para / For MODELOS ELÉTRICOS 778x954x300 mm 0,3 kW - 230 V	<b>3.330,00</b>
	4001.440 SISTEMA LAVAGEM AUTOMÁTICO KILCS2 P/ FORNOS MOD: ICET-ICGT	Modelos T (inclui 1 embalagem Detergente)	<b>963,00</b>

**VAPOR DIRETO | VAPEUR DIRECT | VAPOR DIRECTO | DIRECT STEAM**

Comandos Touch  
 Sistema de lavagem automática fornecido com 1 recipiente de detergente líquido. Sonda multiponto de Ø 3 mm. Sonda fixa  
 Conexão Wifi  
 Conexão USB  
 Suporte de grelhas  
 Para os modelos com caldeira (em opção fornecido com Sistema anticalcário.



Commandes tactiles  
 Système de lavage automatique fourni avec 1 bidon de lessive liquide. Sonde multipoints Ø 3 mm. Sonde fixe  
 Connexion Wifi  
 Connexion USB  
 Support de gril  
 Pour les modèles avec chaudière (en option). Fourni avec système anticalcaire.



Comandos táctiles  
 Sistema de lavado automático suministrado con 1 bote de detergente líquido.  
 Sonda multipunto de Ø 3 mm. Sonda fija  
 Conexión Wifi  
 Conexión USB  
 Soporte de rejilla  
 Para modelos con caldera (en opción). Se suministra con sistema antical.



Touch commands  
 Automatic washing system supplied with 1 container of liquid detergent. Ø 3 mm multipoint probe. Fixed probe  
 Wifi connection  
 USB connection  
 Grill support  
 For models with boiler (in option). Supplied with anti-scale system.



**NOVO**  
**NOUVEAU**  
**NUEVO**  
**NEW**



**NOVO**  
**NOUVEAU**  
**NUEVO**  
**NEW**



MODELO / MODÈLE / MODELO / MODEL CÓDIGO / CODE / CÓDIGO / CODE		SYE061B 4001.602	SYG061B 4001.604
<b>Preço / Prix / Precio / Price</b>	€	<b>12.363,00</b>	<b>14.780,00</b>
Dimensões / Dimensions / Dimensiones	mm	852x795x775	852x795x775
Capacidade da câmara / Chambre capacite / Capacidad cámara / Chamber capacity	Gn's	6x1/1 GN	6x1/1 GN
Espaço entre as prateleiras / Espace entre étagères / Espacio entre las estanterías / Space between shelves	mm	70	70
Potência Térmica Nominal/ Puissance Thermique Nominale/ Nominal Thermal Power	kW/ Kcal	N/A	13/11.180
Potência Total / Puissance Total / Potencia Total / Total Power	kW	9,5	0,7
Peso Líquido-Bruto /Poids Net-Brut /Peso Neto-Bruto /Net-Gross Weight	Kg	110/134,1	115/139
Tensão / Tension / Tensión / Tension	V	400	230



MODELO / MODÈLE / MODELO / MODEL CÓDIGO / CODE / CÓDIGO / CODE		SYE101B 4001.606	SYG101B 4001.608
<b>Preço / Prix / Precio / Price</b>	€	<b>15.452,00</b>	<b>18.138,00</b>
Dimensões / Dimensions / Dimensiones	mm	852x795x1055	852x795x1055
Capacidade da câmara / Chambre capacite / Capacidad cámara / Chamber capacity	Gn's	10x 1/1 GN	10x 1/1 GN
Espaço entre as prateleiras / Espace entre étagères / Espacio entre las estanterías / Space between shelves	mm	70	70
Potência Térmica Nominal/ Puissance Thermique Nominale/ Nominal Thermal Power	kW/ Kcal	N/A	22/18920
Potência Total / Puissance Total / Potencia Total / Total Power	kW	16	0,8
Peso Líquido-Bruto /Poids Net-Brut /Peso Neto-Bruto /Net-Gross Weight	Kg	120/145	125/150
Tensão / Tension / Tensión / Tension	V	400	230

**OPCIONAIS / OPTIONNELLES / OPCIONALES / OPTIONALS**

Cód.	MODELO / MODÈLE / MODELO / MODEL	€
	4001.626 CALDEIRA PARA MODELO ELETRICO 6x1/1GN	<b>1.486,00</b>
	4001.628 CALDEIRA PARA MODELO GAS 6x1/1GN	<b>2.422,00</b>
	4001.630 CALDEIRA PARA MODELO ELETRICO 10x1/1	<b>2.203,00</b>
	4001.632 CALDEIRA PARA MODELO GAS 10x1/1GN	<b>3.742,00</b>
	4001.634 SUPORTE INOX COM PORTA TABULEIROS - 1/1 GN	<b>2.141,00</b>
	4001.636 SUPORTE INOX COM PORTA TABULEIROS - 1/1GN E PORTAS	<b>2.492,00</b>

Recomenda-se a ligação a depurador nos fornos a vapor  
 Le raccordement à l'épurateur dans les fours à vapeur est recommandé  
 Se recomienda la conexión al depurador en hornos de vapor  
 Connection to scrubber in steam ovens is recommended

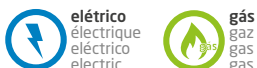

**UDI****sob pedido**  
sur demande  
a pedido  
on request**FORNOS COMBINADOS - TOUCH**

FOURS COMBI - TOUCH

HORNOS COMBI - TOUCH



COMBI OVENS - TOUCH

**VAPOR DIRETO | VAPEUR DIRECT | VAPOR DIRECTO | DIRECT STEAM****Comandos Touch**  
Sistema de lavagem automática fornecido com 1 recipiente de detergente líquido. Sonda multiponto de Ø 3 mm. Sonda fixa  
Conexão Wifi  
Conexão USB  
Suporte de grelhas  
Para os modelos com caldeira (em opção fornecido com Sistema anticalcário.**Commandes tactiles**  
Système de lavage automatique fourni avec 1 bidon de lessive liquide. Sonde multipoints Ø 3 mm. Sonde fixe  
Connexion Wifi  
Connexion USB  
Support de gril  
Pour les modèles avec chaudière (en option). Fourni avec système anticalcaire.**Comandos táctiles**  
Sistema de lavado automático suministrado con 1 bote de detergente líquido. Sonda multipunto de Ø 3 mm. Sonda fija  
Conexión Wifi  
Conexión USB  
Soporte de rejilla  
Para modelos con caldera (en opción). Se suministra con sistema antical.**Touch commands**  
Automatic washing system supplied with 1 container of liquid detergent. Ø 3 mm multipoint probe. Fixed probe  
Wifi connection  
USB connection  
Grill support  
For models with boiler (in option). Supplied with anti-scale system.**NOVO**  
**NOUVEAU**  
**NUEVO**  
**NEW****NOVO**  
**NOUVEAU**  
**NUEVO**  
**NEW**

MODELO / MODÈLE / MODELO / MODEL CÓDIGO / CODE / CÓDIGO / CODE	SYE062B 4001.610	SYG062B 4001.612
<b>Preço / Prix / Precio / Price</b>	€ <b>17.198,00</b>	<b>20.152,00</b>
Dimensões / Dimensions / Dimensiones	mm 1072x907x775	852x795x775
Capacidade da câmara / Chambre capacite / Capacidad cámara / Chamber capacity	Gn's 6x2/1-12x1/1	6x2/1-12x1/1
Espaço entre as prateleiras / Espace entre étagères / Espacio entre las estanterías / Space between shelves	mm 70	70
Potência Térmica Nominal/ Puissance Thermique Nominale/ Nominal Thermal Power	kW/ Kcal N/A	26/22360
Potência Total / Puissance Total / Potencia Total / Total Power	kW 19	0,8
Peso Líquido-Bruto / Poids Net-Brut / Peso Neto-Bruto / Net-Gross Weight	Kg 120/148	125/153
Tensão / Tension / Tensión / Tension	V 400	230

MODELO / MODÈLE / MODELO / MODEL CÓDIGO / CODE / CÓDIGO / CODE	SYE102B 4001.614	SYG102B 4001.616
<b>Preço / Prix / Precio / Price</b>	€ <b>22.166,00</b>	<b>25.523,00</b>
Dimensões / Dimensions / Dimensiones	mm 1072x907x1055	1072x907x1055
Capacidade da câmara / Chambre capacite / Capacidad cámara / Chamber capacity	Gn's 10x2/1-20x1/1	10x2/1-20x1/1
Espaço entre as prateleiras / Espace entre étagères / Espacio entre las estanterías / Space between shelves	mm 70	70
Potência Térmica Nominal/ Puissance Thermique Nominale/ Nominal Thermal Power	kW/ Kcal N/A	42/36120
Potência Total / Puissance Total / Potencia Total / Total Power	kW 31	0,8
Peso Líquido-Bruto / Poids Net-Brut / Peso Neto-Bruto / Net-Gross Weight	Kg 160/190	190/220
Tensão / Tension / Tensión / Tension	V 400	230

**OPCIONAIS / OPTIONNELLES / OPCIONALES / OPTIONALS**

Cód.	MODELO / MODÈLE / MODELO / MODEL	€
	4001.638 CALDEIRA PARA MODELO ELETRICO 6x2/1GN-12x1/1GN 4001.640 CALDEIRA PARA MODELO GAS 6x2/1GN-12x1/1GN 4001.642 CALDEIRA PARA MODELO ELETRICO 10x2/1-20x1/1GN 4001.644 CALDEIRA PARA MODELO GAS 10x2/1-20x1/1GN	<b>2.453,00</b> <b>4.007,00</b> <b>4.132,00</b> <b>4.988,00</b>
	4001.646 SUPORTE INOX COM PORTA TABULEIROS - 2/1 GN	<b>2.391,00</b>
	4001.648 SUPORTE INOX COM PORTA TABULEIROS - 2/1 GN E PORTAS	<b>2.778,00</b>

**Recomenda-se a ligação a depurador nos fornos a vapor**  
Le raccordement à l'épurateur dans les fours à vapeur est recommandé  
Se recomienda la conexión al depurador en hornos de vapor  
Connection to scrubber in steam ovens is recommended

OPCIONAIS ICEM-ICET-ICGM-ICGT / OPTIONNELLES ICEM-ICET-ICGM-ICGT / OPCIONALES ICEM-ICET-ICGM-ICGT / ICEM-ICET-ICGM-ICGT OPTIONALS 261

**VAPOR DIRETO | VAPEUR DIRECT | VAPOR DIRECTO | DIRECT STEAM**

Comandos Touch  
 Sistema de lavagem automática fornecido com 1 recipiente de detergente líquido. Sonda multiponto de Ø 3 mm. Sonda fixa  
 Conexão Wifi  
 Conexão USB  
 Suporte de grelhas  
 Para os modelos com caldeira **(opcional)** fornecido com sistema anticálcario.  
 1 carro incluído.



Commandes tactiles  
 Système de lavage automatique fourni avec 1 bidon de lessive liquide. Sonde multipoints Ø 3 mm. Sonde fixe  
 Connexion Wifi  
 Connexion USB  
 Support de gril  
 Pour les modèles avec chaudière **(en option)** fourni avec système anticalcatoire.  
 1 chariot inclus.



Comandos táctiles  
 Sistema de lavado automático suministrado con 1 bote de detergente líquido. Sonda multipunto de Ø 3 mm. Sonda fija  
 Conexión Wifi  
 Conexión USB  
 Soporte de rejilla  
 Para modelos con caldera **(en opción)** se suministra con sistema antical.  
 1 carro incluído.



Touch commands  
 Automatic washing system supplied with 1 container of liquid detergent. Ø 3 mm multipoint probe. Fixed probe  
 Wifi connection  
 USB connection  
 Grill support  
 For models with boiler **(optional)** supplied with anti-scale system.  
 1 trolley included



**NOVO**  
**NOUVEAU**  
**NUEVO**  
**NEW**



MODELO / MODÈLE / MODELO / MODEL		SYE201B	SYG201B
CÓDIGO / CODE / CÓDIGO / CODE		4001.618	4001.620
<b>Preço / Prix / Precio / Price</b>	€	<b>30.223,00</b>	<b>35.595,00</b>
Dimensões / Dimensions / Dimensiones	mm	892x862x1812	892x862x1812
Capacidade da câmara / Chambre capacite / Capacidad cámara / Chamber capacity	Gn's	20x1/1	20x1/1
Espaço entre as prateleiras / Espace entre étagères / Espacio entre las estanterías / Space between shelves	mm	63	63
Potência Térmica Nominal/ Puissance Thermique Nominale/ Nominal Thermal Power	kW/ Kcal	N/A	44/37840
Potência Total / Puissance Total / Potencia Total / Total Power	kW	31,8	1,3
Peso Líquido-Bruto / Poids Net-Brut / Peso Neto-Bruto / Net-Gross Weight	Kg	201/231	345/375
Tensão / Tension / Tensión / Tension	V	400	230

**NOVO**  
**NOUVEAU**  
**NUEVO**  
**NEW**



MODELO / MODÈLE / MODELO / MODEL		SYE202B	SYG202B
CÓDIGO / CODE / CÓDIGO / CODE		4001.622	4001.624
<b>Preço / Prix / Precio / Price</b>	€	<b>36.938,00</b>	<b>42.980,00</b>
Dimensões / Dimensions / Dimensiones	mm	1102x932x1812	1102x932x1812
Capacidade da câmara / Chambre capacite / Capacidad cámara / Chamber capacity	Gn's	20x2/1-40x1/1	20x2/1-40x1/1
Espaço entre as prateleiras / Espace entre étagères / Espacio entre las estanterías / Space between shelves	mm	63	63
Potência Térmica Nominal/ Puissance Thermique Nominale/ Nominal Thermal Power	kW/ Kcal	N/A	80/68800
Potência Total / Puissance Total / Potencia Total / Total Power	kW	61,8	1,4
Peso Líquido-Bruto / Poids Net-Brut / Peso Neto-Bruto / Net-Gross Weight	Kg	395/425	465/495
Tensão / Tension / Tensión / Tension	V	400	230

**OPCIONAIS / OPTIONNELLES / OPCIONALES / OPTIONALS**

Cód.	MODELO / MODÈLE / MODELO / MODEL	€
	4001.650 CALDEIRA PARA MODELO ELETRICO 20x1/1GN	<b>4.367,00</b>
	4001.652 CALDEIRA PARA MODELO GAS 20x1/1GN	<b>5.158,00</b>
	4001.654 CALDEIRA PARA MODELO ELETRICO 20x2/1-40x1/1GN	<b>6.418,00</b>
	4001.656 CALDEIRA PARA MODELO GAS 20x2/1-40x1/1GN	<b>7.788,00</b>



Recomenda-se a ligação a depurador nos fornos a vapor

Le raccordement à l'épurateur dans les fours à vapeur est recommandé  
 Se recomienda la conexión al depurador en hornos de vapor  
 Connection to scrubber in steam ovens is recommended









UDI

sob pedido  
sur demande  
a pedido  
on request

**FORNOS - SY - ACESSÓRIOS E OPCIONAIS**  
FOURS - SY - ACCESSOIRES ET OPTIONNELS  
HORNOS LBE - SY - ACCESORIOS Y OPCIONALES  
OVENS - SY - ACCESSORIES AND OPTIONALS

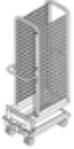

Cód.	Modelo	Obs.	€
	4001.448 SUPORTE INOX NSR071 P/ LBE / LVE / LBG / LVG 071	875x725x860mm	<b>1.017,00</b>
	4001.466 DETERGENTE LIMPEZA DL010 10 LT. P/ FORNO	10Lt	<b>132,00</b>
	4001.512 CARRO PORTA TABULEIROS NKS201 P/ MODELO: LBES / LVES / LBGS / LVGS	490x715x1710H mm 20x1/1GN; Distância entre guias: 63;	<b>2.796,00</b>
	4001.514 CARRO PORTA TABULEIROS KKS202 P/ MODELO: LBE / LVE / LBG / LVG	690x835x1710 20x2/1GN; 40x1/1GN; Distância entre guias: 63mm;	<b>3.150,00</b>

**VAPOR DIRETO | VAPEUR DIRECT | VAPOR DIRECTO | DIRECT STEAM**

Forno ventilado  
Com painel control mecânico  
Camara de cozedura em aço inox AISI304  
Controlo de temperatura por termostato  
Vapor directo controlado por um botão (5 níveis)  
Suportes bivalentes para GN 1/1 e 600x400



Horno ventilada;  
Panel de control mecanico;  
Camara de cocción en acero inoxidable AISI304;  
Control de temperatura por termostato;  
Vapor directo controlado por un botón (5 niveles);  
Soportes bivalentes para GN 1/1 y 600 x 400



Four ventilé;  
Avec panneau de commande mécanique;  
Chambre cuisson AISI304 en acier inoxydable;  
Température de régulation;  
Vapeur directe commandé par un bouton avec affichage (5 niveaux);  
Supports bivalents pour GN 1/1 et 600 x 400



Ventilated oven;  
With mechanical control panel;  
Stainless steel AISI304 cooking chamber;  
Control of the temperature by thermostat;  
Direct steam controlled by one button (5 levels);  
Bivalent brackets for 1/1 GN and 600 x 400

Compatível / compatible / compatible / compatible  
GN 1/1  
600x400



confirmar disponibilidade dos produtos desta página  
confirmer la disponibilité des produits sur cette page  
confirmar la disponibilidad de los productos de esta página  
confirm the availability of the products on this page

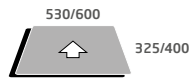

MODELO / MODÈLE / MODELO / MODEL	UDFMGDM416	
CÓDIGO / CODE / CÓDIGO / CODE	2106.304	
<b>Preço / Prix / Precio / Price</b>	<b>€</b>	<b>4.282,00</b>
Dimensões / Dimensions / Dimensiones	mm	932x974x829
Capacidade da câmara / chambre capacité / capacidad cámara / Chamber capacity	nr/mm	4x 1/1 - 4x 600x400
Espaço entre prateleiras / Espace étagères / Espacio entre estanterías / Shelves space	mm	68
Temperatura / Temperature / Temperatura / Temperature	°C	100/260
Peso Líquido - Bruto / Poids Net - Brut / Peso Net - Bruto / Net - Gross Weight	Kg	99,2 / 117
Consumo G20 (Gás natural) / Consommation G20 (Gaz Naturel) / Consumo G20 (Gas Natural) / Consumption G20 (Natural Gas)	m <sup>3</sup> /h	0,952
Consumo G30/31 / Consommation GPL 30/31 / Consumo GPL 30/31 / Consumption GPL 30/31	Kg/h	0,710/0,699
Motor / Moteur / Motor / Motor	nr	1 Bi-Dir.
Potência Nominal / Puissance Nominal / Potencia Nominal / Nominal Power	Qn/kW	9
Potência Total / Puissance Total / Potencia Total / Total Power	kW	0,30
Tensão / Tension / Tensión / Tension	V	230



MODELO / MODÈLE / MODELO / MODEL	UDFMGDM1016	
CÓDIGO / CODE / CÓDIGO / CODE	2106.308	
<b>Preço / Prix / Precio / Price</b>	<b>€</b>	<b>5.992,00</b>
Dimensões / Dimensions / Dimensiones	mm	932x974x1228
Capacidade da câmara / chambre capacité / capacidad cámara / Chamber capacity	nr/mm	10x1/1 - 10x600x400
Espaço entre prateleiras / Espace étagères / Espacio entre estanterías / Shelves space	mm	68
Temperatura / Temperature / Temperatura / Temperature	°C	100/260
Peso Líquido - Bruto / Poids Net - Brut / Peso Net - Bruto / Net - Gross Weight	Kg	150,60 / -
Consumo G20 (Gás natural) / Consommation G20 (Gaz Naturel) / Consumo G20 (Gas Natural) / Consumption G20 (Natural Gas)	m <sup>3</sup> /h	1,852
Consumo G30/31 / Consommation GPL 30/31 / Consumo GPL 30/31 / Consumption GPL 30/31	Kg/h	1,380/1,360
Motor / Moteur / Motor / Motor	nr	2 Bi-Dir.
Potência Nominal / Puissance Nominal / Potencia Nominal / Nominal Power	Qn/kW	18
Potência Total / Puissance Total / Potencia Total / Total Power	kW	0,70
Tensão / Tension / Tensión / Tension	V	230



UDi

**FORNOS COMBINADOS - ELETRÓNICOS - UDF**

FOURS COMBI - ÉLECTRONIQUES - UDF

HORNOS COMBI - ELECTRÓNICO - UDF

COMBI OVENS - ELECTRONIC - UDF

**VAPOR DIRETO | VAPEUR DIRECT | VAPOR DIRECTO | DIRECT STEAM**

Compatível / compatible /  
compatible / compatible  
GN 1/1  
600x400

530/600

325/400



confirmar disponibilidade dos produtos desta página  
confirmer la disponibilité des produits sur cette page  
confirmar la disponibilidad de los productos de esta página  
confirm the availability of the products on this page

MODELO / MODÈLE / MODELO / MODEL	UDFMGDE416	
CÓDIGO / CODE / CÓDIGO / CODE	2106.314	
<b>Preço / Prix / Precio / Price</b>	€	<b>6.496,00</b>
Dimensões / Dimensions / Dimensiones	mm	932x974x829
Capacidade da câmara / chambre capacité / capacidad cámara / Chamber capacity	nr/mm	4x 1/1 - 4x 600x400
Espaço entre prateleiras / Espace étagères / Espacio entre estanterías / Shelves space	mm	68
Temperatura / Temperature / Temperatura / Temperature	°C	50/260
Peso Líquido - Bruto / Poids Net - Brut / Peso Net - Bruto / Net - Gross Weight	Kg	99 / 116,8
Motor / Moteur / Motor / Motor	nr	1 Bi-dir.
Potência Total / Puissance Total / Potencia Total / Total Power	kW	9
Tensão / Tension / Tensión / Tension	V	230



MODELO / MODÈLE / MODELO / MODEL	UDFMGDE616	
CÓDIGO / CODE / CÓDIGO / CODE	2106.316	
<b>Preço / Prix / Precio / Price</b>	€	<b>7.739,00</b>
Dimensões / Dimensions / Dimensiones	mm	932x974x908
Capacidade da câmara / chambre capacité / capacidad cámara / Chamber capacity	nr/mm	6x1/1 - 6x600x400
Espaço entre prateleiras / Espace étagères / Espacio entre estanterías / Shelves space	mm	68
Temperatura / Temperature / Temperatura / Temperature	°C	50/260
Peso Líquido - Bruto / Poids Net - Brut / Peso Net - Bruto / Net - Gross Weight	Kg	117,20 / 135
Motor / Moteur / Motor / Motor	nr	2 Bi-dir.
Potência Total / Puissance Total / Potencia Total / Total Power	kW	13,50
Tensão / Tension / Tensión / Tension	V	230



MODELO / MODÈLE / MODELO / MODEL	UDFCEVDE1016	
CÓDIGO / CODE / CÓDIGO / CODE	2106.312	
<b>Preço / Prix / Precio / Price</b>	€	<b>7.243,00</b>
Dimensões / Dimensions / Dimensiones	mm	932x926x1144
Capacidade da câmara / chambre capacité / capacidad cámara / Chamber capacity	nr/mm	10x1/1 - 10x600x400
Espaço entre prateleiras / Espace étagères / Espacio entre estanterías / Shelves space	mm	68
Temperatura / Temperature / Temperatura / Temperature	°C	50/270
Peso Líquido - Bruto / Poids Net - Brut / Peso Net - Bruto / Net - Gross Weight	Kg	134,8 / 152,4
Motor / Moteur / Motor / Motor	nr	3 Bi-Dir..
Potência Total / Puissance Total / Potencia Total / Total Power	kW	16
Tensão / Tension / Tensión / Tension	V	400



MODELO / MODÈLE / MODELO / MODEL	UDFMGDE1111	
CÓDIGO / CODE / CÓDIGO / CODE	2106.120	
<b>Preço / Prix / Precio / Price</b>	€	<b>8.548,00</b>
Dimensões / Dimensions / Dimensiones	mm	932x974x1228
Capacidade da câmara / chambre capacité / capacidad cámara / Chamber capacity	nr/mm	11x1/1
Espaço entre prateleiras / Espace étagères / Espacio entre estanterías / Shelves space	mm	68
Temperatura / Temperature / Temperatura / Temperature	°C	50/260
Peso Líquido - Bruto / Poids Net - Brut / Peso Net - Bruto / Net - Gross Weight	Kg	150,4/168,4
Motor / Moteur / Motor / Motor	nr	2 Bi-Dir.
Potência Total / Puissance Total / Potencia Total / Total Power	kW	18
Tensão / Tension / Tensión / Tension	V	230

Recomenda-se a ligação a depurador nos fornos a vapor  
Le raccordement à l'épurateur dans les fours à vapeur est recommandé  
Se recomienda la conexión al depurador en hornos de vapor  
Connection to scrubber in steam ovens is recommended



OPCIONAIS UDF / OPTIONNELLES UDF / OPCIONALES UDF / UDF OPTIONALS 264

Consulte condições na pág. 6 • Voir conditions dans la page 6 • Ver condiciones en la pág. 6 • Conditions on page 6



Cód.	Modelo	Obs.		
	2106.518	CHUVEIRO EXTERNO PARA MODELOS 416/616/1016	CHUVEIRO EXTERNO PARA MODELOS 616/1016	<b>354,00</b>
	2106.520	SISTEMA AUTOMÁTICO DE LAVAGEM MOD. ELECT.TOUCH 416/616/1016	SISTEMA AUTOMÁTICO DE LAVAGEM MOD. ELECT.TOUCH 616/	<b>808,00</b>
	2106.522	SONDA AO CENTRO P/MODELOS ELECTR. TOUCH 416/616/1016	SONDA AO CENTRO P/MODELOS ELECTR. TOUCH 616/1016	<b>365,00</b>

**confirmar disponibilidade dos produtos desta página**

 confirmer la disponibilité des produits sur cette page  
 confirmar la disponibilidad de los productos de esta página  
 confirm the availability of the products on this page





UDI

Compatível / compatible /  
compatible / compatible  
GN 2/1  
650x530

**FORNOS COMBINADOS - ELETRÓNICOS - UDF**

FOURS COMBI - ÉLECTRONIQUES - UDF

HORNOS COMBI - ELECTRÓNICO - UDF

COMBI OVENS - ELECTRONIC - UDF



Forno elétrico combinado 10 tabuleiros GN2/1 com painel eletromecânico, o novo forno permite uma gestão de alta performance para obter os melhores resultados na cozinha com uma excelente uniformidade da cozedura e tempos rápidos com uma consequente redução do consumo.



Four électrique combiné convection vapeur 10 plaques 2/1GN avec panneau électromécanique, le nouveau four permet une gestion de haute performance pour obtenir les meilleurs résultats dans la cuisine avec une excellente uniformité de cuisson et des temps rapides avec une réduction conséquente de la consommation.



Four électrique combiné convection vapeur 10 plaques 2/1GN avec panneau électromécanique, le nouveau four permet une gestion de haute performance pour obtenir les meilleurs résultats dans la cuisine avec une excellente uniformité de cuisson et des temps rapides avec une réduction conséquente de la consommation.



Electric combi oven with a three-knob electromechanical panel, allows high-performance management for achieving the best results in the kitchen with excellent, even cooking and fast times that result in reduced consumption.

NOVO  
NOUVEAU  
NUEVO  
NEW



MODELO / MODÈLE / MODELO / MODEL		UDFSE1021
CÓDIGO / CODE / CÓDIGO / CODE		2106.740
<b>Preço / Prix / Precio / Price</b>	<b>€</b>	<b>9.404,00</b>
Dimensões / Dimensions / Dimensiones	mm	850x1041x1130
Capacidade Tabuleiros / Capacité plateaux / Capacidad bandejas / Tray Capacity	nr	10
Espaço entre prateleiras / Espace étagères / Espacio entre estanterías / Shelves space	mm	80
Temperatura / Temperature / Temperatura / Temperature	°C	100-270
Peso Líquido - Bruto / Poids Net - Brut / Peso Net - Bruto / Net - Gross Weight	Kg	140,4
Motor / Moteur / Motor / Motor	nr	3 bi-dir.
Potência Total / Puissance Total / Potencia Total / Total Power	kW	27,5
Tensão / Tension / Tensión / Tension	V	400



NOVO  
NOUVEAU  
NUEVO  
NEW



MODELO / MODÈLE / MODELO / MODEL		UDFBME1021
CÓDIGO / CODE / CÓDIGO / CODE		2106.745
<b>Preço / Prix / Precio / Price</b>	<b>€</b>	<b>10.363,00</b>
Dimensões / Dimensions / Dimensiones	mm	850x1035x1130
Capacidade Tabuleiros / Capacité plateaux / Capacidad bandejas / Tray Capacity	nr	10
Espaço entre prateleiras / Espace étagères / Espacio entre estanterías / Shelves space	mm	80
Temperatura / Temperature / Temperatura / Temperature	°C	30-270
Peso Líquido - Bruto / Poids Net - Brut / Peso Net - Bruto / Net - Gross Weight	Kg	140,4
Motor / Moteur / Motor / Motor	nr	3 bi-dir.
Potência Total / Puissance Total / Potencia Total / Total Power	kW	27,5
Tensão / Tension / Tensión / Tension	V	400



NOVO  
NOUVEAU  
NUEVO  
NEW



MODELO / MODÈLE / MODELO / MODEL		UDFTSE1021
CÓDIGO / CODE / CÓDIGO / CODE		2106.750
<b>Preço / Prix / Precio / Price</b>	<b>€</b>	<b>12.450,00</b>
Dimensões / Dimensions / Dimensiones	mm	850x1035x1130
Capacidade Tabuleiros / Capacité plateaux / Capacidad bandejas / Tray Capacity	nr	10
Espaço entre prateleiras / Espace étagères / Espacio entre estanterías / Shelves space	mm	80
Temperatura / Temperature / Temperatura / Temperature	°C	30 - 270
Peso Líquido - Bruto / Poids Net - Brut / Peso Net - Bruto / Net - Gross Weight	Kg	140,4
Motor / Moteur / Motor / Motor	nr	3 bi-dir.
Potência Total / Puissance Total / Potencia Total / Total Power	kW	27,5
Tensão / Tension / Tensión / Tension	V	400



NOVO  
NOUVEAU  
NUEVO  
NEW



MODELO / MODÈLE / MODELO / MODEL		UDFTSG1021
CÓDIGO / CODE / CÓDIGO / CODE		2106.755
<b>Preço / Prix / Precio / Price</b>	<b>€</b>	<b>13.058,00</b>
Dimensões / Dimensions / Dimensiones	mm	850x1035x1230
Capacidade Tabuleiros / Capacité plateaux / Capacidad bandejas / Tray Capacity	nr	10
Espaço entre prateleiras / Espace étagères / Espacio entre estanterías / Shelves space	mm	80
Temperatura / Temperature / Temperatura / Temperature	°C	30 - 260
Peso Líquido - Bruto / Poids Net - Brut / Peso Net - Bruto / Net - Gross Weight	Kg	158
Motor / Moteur / Motor / Motor	nr	3 bi-dir.
Potência Total / Puissance Total / Potencia Total / Total Power	kW	18
Tensão / Tension / Tensión / Tension	V	230



elétrico  
électrique  
elétrico  
electric



gás  
gaz  
gas  
gas

OPCIONAIS UDF / OPTIONNELLES UDF / OPCIONALES UDF / UDF OPTIONALS 274&gt;275

Consulte condições na pág. 6 • Voir conditions dans la page 6 • Ver condiciones en la pág. 6 • Conditions on page 6

**VAPOR DIRETO | VAPEUR DIRECT | VAPOR DIRECTO | DIRECT STEAM**

Forno elétrico combinado GN1/1 ou tabuleiros 600x400mm  
 Painel eletromecânico e possibilidade de sobreposição.  
 Qualidade em um forno simples e de alto desempenho



Horno eléctrico combinado GN1/1 ou bandejas 600x400mm Panel electromecánico y posibilidad de superposición. Calidad en un horno sencillo y de alto rendimiento.



Four électrique combiné plateaux GN1/1 ou 600x400 mm  
 Panneau électromécanique et possibilité de chevauchement.  
 Qualité dans un four simple et performant.



Combined electric oven GN1/1 or 600x400 mm trays Electromechanical panel and possibility of overlap.  
 Quality in a simple and high performance oven

Compatible / compatible / compatible / compatible  
 GN 1/1  
 600x400

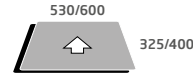

MODELO / MODÈLE / MODELO / MODEL	UDFSG416	
CÓDIGO / CODE / CÓDIGO / CODE	2106.608	
<b>Preço / Prix / Precio / Price</b>	€	<b>4.685,00</b>
Dimensões / Dimensions / Dimensiones	mm	850x1041x801
Capacidade Tabuleiros / Capacité plateaux / Capacidad bandejas / Tray Capacity	nr	4
Espaço entre prateleiras / Espace étagères / Espacio entre estanterías / Shelves space	mm	80
Temperatura / Temperature / Temperatura / Temperature	°C	100-260
Peso Líquido - Bruto / Poids Net - Brut / Peso Net - Bruto / Net - Gross Weight	Kg	102
Motor / Moteur / Motor / Motor	nr	1 bi-dir.
Potência Total / Puissance Total / Potencia Total / Total Power	kW	9,3
Tensão / Tension / Tensión / Tension	V	230



MODELO / MODÈLE / MODELO / MODEL	UDFSE616	UDFSG616	
CÓDIGO / CODE / CÓDIGO / CODE	2106.604	2106.610	
<b>Preço / Prix / Precio / Price</b>	€	<b>4.180,00</b>	<b>5.376,00</b>
Dimensões / Dimensions / Dimensiones	mm	850x1041x850	850x1041x951
Capacidade Tabuleiros / Capacité plateaux / Capacidad bandejas / Tray Capacity	nr	6	6
Espaço entre prateleiras / Espace étagères / Espacio entre estanterías / Shelves space	mm	80	80
Temperatura / Temperature / Temperatura / Temperature	°C	100-275	100-260
Peso Líquido - Bruto / Poids Net - Brut / Peso Net - Bruto / Net - Gross Weight	Kg	108,2	123
Motor / Moteur / Motor / Motor	nr	2 bi-dir.	2 bi-dir.
Potência Total / Puissance Total / Potencia Total / Total Power	kW	10,4	13,5
Tensão / Tension / Tensión / Tension	V	400	230



MODELO / MODÈLE / MODELO / MODEL	UDFSE1016	UDFSG1016	
CÓDIGO / CODE / CÓDIGO / CODE	2106.606	2106.612	
<b>Preço / Prix / Precio / Price</b>	€	<b>6.095,00</b>	<b>6.611,00</b>
Dimensões / Dimensions / Dimensiones	mm	850x1041x1130	850x1041x1231
Capacidade Tabuleiros / Capacité plateaux / Capacidad bandejas / Tray Capacity	nr	10	10
Espaço entre prateleiras / Espace étagères / Espacio entre estanterías / Shelves space	mm	80	80
Temperatura / Temperature / Temperatura / Temperature	°C	100-275	100-260
Peso Líquido - Bruto / Poids Net - Brut / Peso Net - Bruto / Net - Gross Weight	Kg	140,4	158
Motor / Moteur / Motor / Motor	nr	3 bi-dir.	3 bi-dir.
Potência Total / Puissance Total / Potencia Total / Total Power	kW	15,5	18
Tensão / Tension / Tensión / Tension	V	400	230



Recomenda-se a ligação a depurador nos fornos a vapor  
 Le raccordement à l'épurateur dans les fours à vapeur est recommandé  
 Se recomienda la conexión al depurador en hornos de vapor  
 Connection to scrubber in steam ovens is recommended



UDi

**FORNOS COMBINADOS - ELETRÓNICOS - UDF**

FOURS COMBI - ÉLETRONIQUES - UDF

HORNOS COMBI - ELECTRÓNICO - UDF

COMBI OVENS - ELECTRONIC - UDF



**VAPOR DIRETO | VAPEUR DIRECT | VAPOR DIRECTO | DIRECT STEAM**



Permitem 100 receitas programáveis e a possibilidade de configuração para lavagem automática e sonda ao centro. Equipados com ventiladores distribuídos em altura para garantir uma cozedura uniforme em todos os seus pratos.



Permiten 100 recetas programables y la posibilidad de configuración para lavado automático y sonda en el centro. Equipado con ventiladores distribuidos en altura para asegurar una cocción uniforme en todos tus platos.



Ils permettent 100 recettes programmables et la possibilité de configuration pour lavage automatique et sonde au centre. Equipé de ventilateurs répartis en hauteur pour assurer une cuisson uniforme dans tous vos plats.



They allow 100 programmable recipes and the possibility of configuration for automatic washing and probe in the center. Equipped with fans distributed in height to ensure uniform cooking in all your dishes.

Compatível / compatible / compatible / compatible  
GN 1/1  
600x400

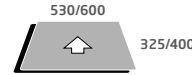

MODELO / MODÈLE / MODELO / MODEL CÓDIGO / CODE / CÓDIGO / CODE	UDFBMG416	
<b>Preço / Prix / Precio / Price</b>	€	<b>7.137,00</b>
Dimensões / Dimensions / Dimensiones	mm	850x1035x801
Capacidade Tabuleiros / Capacité plateaux / Capacidad bandejas / Tray Capacity	nr	4
Espaço entre prateleiras / Espace étagères / Espacio entre estanterías / Shelves space	mm	80
Temperatura / Temperature / Temperatura / Temperature	°C	30-260
Peso Líquido - Bruto / Poids Net - Brut / Peso Net - Bruto / Net - Gross Weight	Kg	102
Motor / Moteur / Motor / Motor	nr	1 bi-dir.
Potência Total / Puissance Total / Potencia Total / Total Power	kW	9,3
Tensão / Tension / Tensión / Tension	V	230



MODELO / MODÈLE / MODELO / MODEL CÓDIGO / CODE / CÓDIGO / CODE	UDFBME616	UDFBMG616	
<b>Preço / Prix / Precio / Price</b>	€	<b>5.922,00</b>	<b>8.710,00</b>
Dimensões / Dimensions / Dimensiones	mm	850x1035x850	850x1035x951
Capacidade Tabuleiros / Capacité plateaux / Capacidad bandejas / Tray Capacity	nr	6	6
Espaço entre prateleiras / Espace étagères / Espacio entre estanterías / Shelves space	mm	80	80
Temperatura / Temperature / Temperatura / Temperature	°C	30-270	30-260
Peso Líquido - Bruto / Poids Net - Brut / Peso Net - Bruto / Net - Gross Weight	Kg	108,2	123
Motor / Moteur / Motor / Motor	nr	2 bi-dir.	2 bi-dir.
Potência Total / Puissance Total / Potencia Total / Total Power	kW	10,4	13,5
Tensão / Tension / Tensión / Tension	V	400	230



MODELO / MODÈLE / MODELO / MODEL CÓDIGO / CODE / CÓDIGO / CODE	UDFBME1016	UDFBMG1016	
<b>Preço / Prix / Precio / Price</b>	€	<b>8.161,00</b>	<b>9.791,00</b>
Dimensões / Dimensions / Dimensiones	mm	850x1035x1130	850x1035x1231
Capacidade Tabuleiros / Capacité plateaux / Capacidad bandejas / Tray Capacity	nr	10	10
Espaço entre prateleiras / Espace étagères / Espacio entre estanterías / Shelves space	mm	80	80
Temperatura / Temperature / Temperatura / Temperature	°C	30-270	30-260
Peso Líquido - Bruto / Poids Net - Brut / Peso Net - Bruto / Net - Gross Weight	Kg	140,4	158
Motor / Moteur / Motor / Motor	nr	3 bi-dir.	3 bi-dir.
Potência Total / Puissance Total / Potencia Total / Total Power	kW	15,5	18
Tensão / Tension / Tensión / Tension	V	400	230



Recomenda-se a ligação a depurador nos fornos a vapor  
Le raccordement à l'épurateur dans les fours à vapeur est recommandé  
Se recomienda la conexión al depurador en hornos de vapor  
Connection to scrubber in steam ovens is recommended



OPCIONAIS UDF / OPTIONNELLES UDF / OPCIONALES UDF / UDF OPTIONALS 274>275

Consulte condições na pág. 6 • Voir conditions dans la page 6 • Ver condiciones en la pág. 6 • Conditions on page 6



Caldeira embutida com controlo automático durante a cozedura a vapor. Abertura da porta a 60°, 90°, 120° e 180°.



Caldera empotrada con control automático durante la cocción al vapor. Apertura de la puerta a 60°, 90°, 120° y 180°.



Chaudière intégrée avec contrôle automatique pendant la cuisson vapeur. Ouverture de la porte à 60°, 90°, 120° et 180°.



Built-in boiler with automatic control during steam cooking. Opening the door at 60°, 90°, 120° and 180°.

Compatível / compatible / compatible / compatible  
GN 1/1

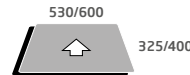

MODELO / MODÈLE / MODELO / MODEL	UDFTSBE711	
CÓDIGO / CODE / CÓDIGO / CODE	2106.640	
<b>Preço / Prix / Precio / Price</b>	<b>€</b>	<b>10.124,00</b>
Dimensões / Dimensions / Dimensiones	mm	730x849x850
Capacidade da câmara / chambre capacité / capacidad cámara / Chamber capacity	nr/mm	7
Espaço entre prateleiras / Espace étagères / Espacio entre estanterías / Shelves space	mm	68
Temperatura / Temperature / Temperatura / Temperature	°C	30/270
Peso / Poids / Peso / Weight	Kg	102
Motor / Moteur / Motor / Motor	nr	2 Bi-Dir.
Potência Total / Puissance Total / Potencia Total / Total Power	kW	15
Tensão / Tension / Tensión / Tension	V	400



MODELO / MODÈLE / MODELO / MODEL	UDFTSBE111	
CÓDIGO / CODE / CÓDIGO / CODE	2106.642	
<b>Preço / Prix / Precio / Price</b>	<b>€</b>	<b>13.199,00</b>
Dimensões / Dimensions / Dimensiones	mm	730x849x1130
Capacidade da câmara / chambre capacité / capacidad cámara / Chamber capacity	nr/mm	11
Espaço entre prateleiras / Espace étagères / Espacio entre estanterías / Shelves space	mm	68
Temperatura / Temperature / Temperatura / Temperature	°C	30/270
Peso / Poids / Peso / Weight	Kg	141
Motor / Moteur / Motor / Motor	nr	2 Bi-Dir.
Potência Total / Puissance Total / Potencia Total / Total Power	kW	19
Tensão / Tension / Tensión / Tension	V	400



UDI

**FORNOS COMBINADOS CARRELADOS - ELETRÓNICOS - UDF**

FOURS COMBI CHARRIOT - ÉLECTRONIQUES - UDF

HORNOS COMBI CARRO - ELECTRÓNICOS - UDF

COMBI OVENS TROLLEY - ELECTRONIC - UDF



Forno elétrico combinado para tabuleiros GN1/1. Equipado até 4 ventiladores distribuídos em altura para garantir uma cozedura uniforme para todos os seus pratos. Pode configurar até 100 receitas da maneira mais fácil e imediata possível e configurar até 10 etapas de cozedura.



Horno eléctrico combinado para bandejas GN1 / 1. Equipado con hasta 4 ventiladores distribuidos en altura para asegurar una cocción uniforme de todos tus platos. Puede configurar hasta 100 recetas de la forma más fácil e inmediata posible y configurar hasta 10 pasos de cocción.



Four électrique combiné pour plateaux GN1 / 1. Équipé de jusqu'à 4 ventilateurs répartis en hauteur pour assurer une cuisson uniforme de tous vos plats. Vous pouvez configurer jusqu'à 100 recettes de la manière la plus simple et la plus immédiate possible et configurer jusqu'à 10 étapes de cuisson.



Combined electric oven for GN1 / 1 trays. Equipped with up to 4 fans distributed in height to ensure uniform cooking for all your dishes. You can configure up to 100 recipes in the easiest and most immediate way possible and configure up to 10 cooking steps.

Compatível / compatible / compatible / compatible  
GN 1/1

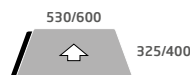

MODELO / MODÈLE / MODELO / MODEL CÓDIGO / CODE / CÓDIGO / CODE	UDFBME2011 2106.626	
<b>Preço / Prix / Precio / Price</b>	€	<b>17.627,00</b>
Dimensões / Dimensions / Dimensiones	mm	850x1035x1900
Capacidade da câmara / chambre capacité / capacidad cámara / Chamber capacity	nr	20X 1/1
Espaço entre prateleiras / Espace étagères / Espacio entre estanterías / Shelves space	mm	66
Temperatura / Temperature / Temperatura / Temperature	°C	30/270
Peso / Poids / Peso / Weight	Kg	247,2
Motor / Moteur / Motor / Motor	nr	4 Bi-dir.
Potência Total / Puissance Total / Potencia Total / Total Power	kW	31
Tensão / Tension / Tensión / Tension	V	400



MODELO / MODÈLE / MODELO / MODEL CÓDIGO / CODE / CÓDIGO / CODE	UDFBMG2011 2106.628	
<b>Preço / Prix / Precio / Price</b>	€	<b>19.351,00</b>
Dimensões / Dimensions / Dimensiones	mm	930x1160x2060
Capacidade da câmara / chambre capacité / capacidad cámara / Chamber capacity	nr	20X 1/1
Espaço entre prateleiras / Espace étagères / Espacio entre estanterías / Shelves space	mm	66
Temperatura / Temperature / Temperatura / Temperature	°C	30/260
Peso / Poids / Peso / Weight	Kg	277
Motor / Moteur / Motor / Motor	nr	4 Bi-dir.
Potência Total / Puissance Total / Potencia Total / Total Power	kW	30
Tensão / Tension / Tensión / Tension	V	230

OPCIONAIS UDF / OPTIONNELLES UDF / OPCIONALES UDF / UDF OPTIONALS 274&gt;275



Consulte condições na pág. 6 • Voir conditions dans la page 6 • Ver condiciones en la pág. 6 • Conditions on page 6



Fornos combinados elétricos COMPACT para tabuleiros GN 1/1. Com apenas 50 cm de largura, este forno oferece todas as inovações que irá garantir um resultado de alto nível. Máxima eficiência no menor espaço, com a possibilidade de usar 100 receitas programáveis!



Hornos combinados eléctricos COMPACT para bandejas GN 1/1. Solo 50 cm de ancho, este horno ofrece todas las innovaciones que garantizará un resultado de alto nivel. ¡Máxima eficiencia en el mínimo espacio, con posibilidad de utilizar 100 recetas programables!



Fours combinés électriques COMPACT pour plateaux GN 1/1. Seulement 50 cm de large, ce four offre toutes les innovations cela garantira un résultat de haut niveau. Efficacité maximale dans le plus petit espace, avec la possibilité d'utiliser 100 recettes programmables!



COMPACT electric combined ovens for GN 1/1 trays. Only 50 cm wide, this oven offers all the innovations that will guarantee a high level result. Maximum efficiency in the smallest space, with the possibility of using 100 programmable recipes!

Compatível / compatible / compatible / compatible GN 1/1

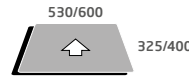

MODELO / MODÈLE / MODELO / MODEL	UDFCBME611	
CÓDIGO / CODE / CÓDIGO / CODE	2106.630	
<b>Preço / Prix / Precio / Price</b>	<b>€</b>	<b>6.956,00</b>
Dimensões / Dimensions / Dimensiones	mm	500x930x700
Capacidade da câmara / chambre capacité / capacidad cámara / Chamber capacity	nr GN 1/1	6
Espaço entre prateleiras / Espace étagères / Espacio entre estanterías / Shelves space	mm	68
Temperatura / Temperature / Temperatura / Temperature	°C	30/270
Peso / Poids / Peso / Weight	Kg	70,8
Motor / Moteur / Motor / Motor	nr	1 Bi-Dir.
Potência Total / Puissance Total / Potencia Total / Total Power	kW	7,8
Tensão / Tension / Tensión / Tension	V	400



MODELO / MODÈLE / MODELO / MODEL	UDFCBME1011	
CÓDIGO / CODE / CÓDIGO / CODE	2106.632	
<b>Preço / Prix / Precio / Price</b>	<b>€</b>	<b>9.027,00</b>
Dimensões / Dimensions / Dimensiones	mm	500x930x970
Capacidade da câmara / chambre capacité / capacidad cámara / Chamber capacity	nr GN 1/1	10
Espaço entre prateleiras / Espace étagères / Espacio entre estanterías / Shelves space	mm	68
Temperatura / Temperature / Temperatura / Temperature	°C	30/270
Peso / Poids / Peso / Weight	Kg	95,2
Motor / Moteur / Motor / Motor	nr	2 Bi-Dir.
Potência Total / Puissance Total / Potencia Total / Total Power	kW	15,4
Tensão / Tension / Tensión / Tension	V	400



UDI

**FORNOS COMBINADOS COMPACT - TOUCH - UDF**

FOURS COMBI BOILER - COMPACT - TOUCH - UDF

HORNOS COMBI DE BOILER - COMPACT - TOUCH - UDF

COMBI OVENS BOILER - COMPACT - TOUCH - UDF



Embora tenha apenas 50 cm de largura, possui todo o potencial para alcançar a uniformidade ideal de cozedura. Um forno compacto, rápido, intuitivo e simples. Projetado para restaurantes que devem aliar toda a tecnologia de um produto de última geração com espaço limitado na cozinha. Eficiência máxima em espaço mínimo.



Aunque solo tiene 50 cm de ancho, tiene todo el potencial para lograr la uniformidad de cocción ideal. Un horno compacto, rápido, intuitivo y sencillo. Diseñado para restaurantes que deben combinar toda la tecnología de un producto de vanguardia con un espacio limitado en la cocina. Máxima eficiencia en el mínimo espacio.



Bien qu'il ne mesure que 50 cm de large, il a tout le potentiel pour atteindre l'uniformité de cuisson idéale. Un four compact, rapide, intuitif et simple. Conçu pour les restaurants qui doivent combiner toute la technologie d'un produit de pointe avec un espace limité dans la cuisine. Efficacité maximale dans un espace minimum.



Although it is only 50 cm wide, it has all the potential to achieve the ideal cooking uniformity. A compact, fast, intuitive and simple oven. Designed for restaurants that must combine all the technology of a cutting edge product with limited space in the kitchen. Maximum efficiency in minimum space.

Compatível / compatible / compatible / compatible  
GN 1/1

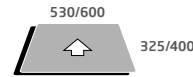

MODELO / MODÈLE / MODELO / MODEL	UDFCTSE611	
CÓDIGO / CODE / CÓDIGO / CODE	2106.654	
<b>Preço / Prix / Precio / Price</b>	€	<b>7.698,00</b>
Dimensões / Dimensions / Dimensiones	mm	500x930x970
Capacidade da câmara / chambre capacité / capacidad cámara / Chamber capacity	nr	6
Espaço entre prateleiras / Espace étagères / Espacio entre estanterías / Shelves space	mm	68
Temperatura / Temperature / Temperatura / Temperature	°C	30/270
Peso / Poids / Peso / Weight	Kg	70,8
Motor / Moteur / Motor / Motor	nr	1 Bi-Dir.
Potência Total / Puissance Total / Potencia Total / Total Power	kW	7,8
Tensão / Tension / Tensión / Tension	V	400



MODELO / MODÈLE / MODELO / MODEL	UDFCTSE1011	
CÓDIGO / CODE / CÓDIGO / CODE	2106.656	
<b>Preço / Prix / Precio / Price</b>	€	<b>10.013,00</b>
Dimensões / Dimensions / Dimensiones	mm	500x930x970
Capacidade da câmara / chambre capacité / capacidad cámara / Chamber capacity	nr	10
Espaço entre prateleiras / Espace étagères / Espacio entre estanterías / Shelves space	mm	68
Temperatura / Temperature / Temperatura / Temperature	°C	30/270
Peso / Poids / Peso / Weight	Kg	95,2
Motor / Moteur / Motor / Motor	nr	2 Bi-Dir.
Potência Total / Puissance Total / Potencia Total / Total Power	kW	15,4
Tensão / Tension / Tensión / Tension	V	400

elétrico  
électrique  
eléctrico  
electricgás  
gaz  
gas  
gas

OPCIONAIS UDF / OPTIONNELLES UDF / OPCIONALES UDF / UDF OPTIONALS 274&gt;275

Consulte condições na pág. 6 • Voir conditions dans la page 6 • Ver condiciones en la pág. 6 • Conditions on page 6

**VAPOR DIRETO | VAPEUR DIRECT | VAPOR DIRECTO | DIRECT STEAM**



500 receitas programáveis que se activam com um simples toque, para confeccionar os seus pratos de forma homogénea. Pode variar as técnicas de cozedura a oferecer aos seus clientes graças à possibilidade de utilizar o vapor.  
 O forno possui abertura de porta de 60°, 90°, 120° e 180°.



500 recetas programables que se activan con un simple toque, para hacer tus platos de forma homogénea. Podrás variar las técnicas de cocción para ofrecer a tus clientes gracias a la posibilidad de utilizar vapor.  
 El horno tiene una apertura de puerta de 60°, 90°, 120° y 180°.



500 recettes programmables qui s'activent d'une simple pression, pour réaliser vos plats de manière homogène. Vous pouvez varier les techniques de cuisson à proposer à vos clients grâce à la possibilité d'utiliser la vapeur.  
 Le four a une ouverture de porte de 60°, 90°, 120° et 180°.



500 programmable recipes that can be activated with a single touch, to make your dishes homogeneously. You can vary the cooking techniques to offer your customers thanks to the possibility of using steam.  
 The oven has a door opening of 60°, 90°, 120° and 180°.

Compatível / compatible / compatible / compatible  
**GN 1/1**  
**600x400**

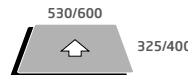

MODELO / MODÈLE / MODELO / MODEL		UDFTSE416	UDFTSG416
CÓDIGO / CODE / CÓDIGO / CODE		2106.634	2106.646
<b>Preço / Prix / Precio / Price</b>	€	<b>7.654,00</b>	<b>10.024,00</b>
Dimensões / Dimensions / Dimensiones	mm	850x1035x700	850x1035x800
Capacidade Tabuleiros / Capacité plateaux / Capacidad bandejas / Tray Capacity	nr	GN1/1 - 600x400 x 4	4
Espaço entre prateleiras / Espace étagères / Espacio entre estanterías / Shelves space	mm	80	80
Temperatura / Temperature / Temperatura / Temperature	°C	30 - 270	30 - 260
Peso Líquido - Bruto / Poids Net - Brut / Peso Net - Bruto / Net - Gross Weight	Kg	92,4	102
Motor / Moteur / Motor / Motor	nr	1 bi-dir.	1 bi-dir.
Potência Total / Puissance Total / Potencia Total / Total Power	kW	7,8	9,3
Tensão / Tension / Tensión / Tension	V	400	230



MODELO / MODÈLE / MODELO / MODEL		UDFTSE616	UDFTSG616
CÓDIGO / CODE / CÓDIGO / CODE		2106.636	2106.648
<b>Preço / Prix / Precio / Price</b>	€	<b>9.478,00</b>	<b>11.091,00</b>
Dimensões / Dimensions / Dimensiones	mm	850x1035x850	850x1035x950
Capacidade Tabuleiros / Capacité plateaux / Capacidad bandejas / Tray Capacity	nr	GN1/1 - 600x400 x 6	6
Espaço entre prateleiras / Espace étagères / Espacio entre estanterías / Shelves space	mm	80	80
Temperatura / Temperature / Temperatura / Temperature	°C	30-270	30 - 260
Peso Líquido - Bruto / Poids Net - Brut / Peso Net - Bruto / Net - Gross Weight	Kg	108,2	123
Motor / Moteur / Motor / Motor	nr	2 bi-dir.	2 bi-dir.
Potência Total / Puissance Total / Potencia Total / Total Power	kW	11,4	13,5
Tensão / Tension / Tensión / Tension	V	400	230



MODELO / MODÈLE / MODELO / MODEL		UDFTSE1016	UDFTSG1016
CÓDIGO / CODE / CÓDIGO / CODE		2106.638	2106.650
<b>Preço / Prix / Precio / Price</b>	€	<b>9.890,00</b>	<b>13.756,00</b>
Dimensões / Dimensions / Dimensiones	mm	850x1035x1130	850x1035x1230
Capacidade Tabuleiros / Capacité plateaux / Capacidad bandejas / Tray Capacity	nr	GN1/1 - 600x400 x 10	10
Espaço entre prateleiras / Espace étagères / Espacio entre estanterías / Shelves space	mm	80	80
Temperatura / Temperature / Temperatura / Temperature	°C	30 - 270	30 - 260
Peso Líquido - Bruto / Poids Net - Brut / Peso Net - Bruto / Net - Gross Weight	Kg	140,4	158
Motor / Moteur / Motor / Motor	nr	3 bi-dir.	3 bi-dir.
Potência Total / Puissance Total / Potencia Total / Total Power	kW	17	18
Tensão / Tension / Tensión / Tension	V	400	230



Recomenda-se a ligação a depurador nos fornos a vapor  
 Le raccordement à l'épurateur dans les fours à vapeur est recommandé  
 Se recomienda la conexión al depurador en hornos de vapor  
 Connection to scrubber in steam ovens is recommended







UDI

## FORNOS COMBINADOS CARRELADOS - TOUCH - UDF

FOURS COMBI CHARIOT - TOUCH - UDF

HORNOS COMBI CARRO - TOUCH - UDF

COMBI OVENS TROLLEY - TOUCH - UDF



### VAPOR DIRETO | VAPEUR DIRECT | VAPOR DIRECTO | DIRECT STEAM



O forno mais potente desta linha, equipado com 4 ventiladores distribuídos em altura, para garantir uma cozedura uniforme a todos os seus pratos. Cozinhe o primeiro e o segundo pratos e acompanhamentos no carro removível de 20 tabuleiros: a estanqueidade impecável da câmara de cozedura é garantida por uma engenhosa patente exclusiva. Somente com esta tecnologia pode realmente sentir-se à vontade para cozinhar grandes quantidades, sem sacrificar a atenção aos detalhes necessários para alcançar um resultado de qualidade.



El horno más potente de esta línea, equipado con 4 ventiladores distribuidos en altura, para garantizar una cocción uniforme de todos tus platos. Cocine el primer y segundo plato y guarniciones en el carro extraíble de 20 sartenes: la impecable estanqueidad de la cámara de cocción está garantizada por una ingeniosa patente exclusiva. Solo con esta tecnología puede sentirse realmente cómodo cocinando grandes cantidades, sin sacrificar la atención al detalle necesaria para lograr un resultado de calidad.



Le four le plus puissant de cette gamme, équipé de 4 ventilateurs répartis en hauteur, pour assurer une cuisson uniforme de tous vos plats. Faites cuire les premier et deuxième plats et accompagnements dans le chariot amovible de 20 plateaux: l'étanchéité impeccable de la chambre de cuisson est garantie par un ingénieux brevet exclusif. Ce n'est qu'avec cette technologie que vous vous sentirez vraiment à l'aise de cuisiner de grandes quantités, sans sacrifier l'attention au détail nécessaire pour obtenir un résultat de qualité.



The most powerful oven in this line, equipped with 4 fans distributed in height, to ensure uniform cooking for all your dishes. Cook the first and second dishes and side dishes in the 20-tray removable trolley; the impeccable tightness of the cooking chamber is guaranteed by an ingenious exclusive patent. Only with this technology can you really feel comfortable cooking large quantities, without sacrificing the attention to detail necessary to achieve a quality result.

Compatível / compatible / compatible / compatible  
GN 1/1  
600x400

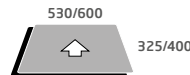

MODELO / MODÈLE / MODELO / MODEL CÓDIGO / CODE / CÓDIGO / CODE	UDFTSE2011 2106.644	
<b>Preço / Prix / Precio / Price</b>	€	<b>22.734,00</b>
Dimensões / Dimensions / Dimensiones	mm	930x1035x1900
Capacidade Tabuleiros / Capacité plateaux / Capacidad bandejas / Tray Capacity	nr	GN1/1 x 20
Espaço entre prateleiras / Espace étagères / Espacio entre estanterías / Shelves space	mm	66
Temperatura / Temperature / Temperatura / Temperature	°C	30 - 270
Peso Líquido - Bruto / Poids Net - Brut / Peso Net - Bruto / Net - Gross Weight	Kg	247,2
Motor / Moteur / Motor / Motor	nr	4 bi-dir.
Potência Total / Puissance Total / Potencia Total / Total Power	kW	31
Tensão / Tension / Tensión / Tension	V	400



MODELO / MODÈLE / MODELO / MODEL CÓDIGO / CODE / CÓDIGO / CODE	UDFTSG2011 2106.652	
<b>Preço / Prix / Precio / Price</b>	€	<b>24.978,00</b>
Dimensões / Dimensions / Dimensiones	mm	930x1162x1954
Capacidade Tabuleiros / Capacité plateaux / Capacidad bandejas / Tray Capacity	nr	GN1/1 x 20
Espaço entre prateleiras / Espace étagères / Espacio entre estanterías / Shelves space	mm	66
Temperatura / Temperature / Temperatura / Temperature	°C	30 - 260
Peso Líquido - Bruto / Poids Net - Brut / Peso Net - Bruto / Net - Gross Weight	Kg	277
Motor / Moteur / Motor / Motor	nr	4 bi-dir.
Potência Total / Puissance Total / Potencia Total / Total Power	kW	30
Tensão / Tension / Tensión / Tension	V	230

Recomenda-se a ligação a depurador nos fornos a vapor  
Le raccordement à l'épurateur dans les fours à vapeur est recommandé  
Se recomienda la conexión al depurador en hornos de vapor  
Connection to scrubber in steam ovens is recommended



OPCIONAIS UDF / OPTIONNELLES UDF / OPCIONALES UDF / UDF OPTIONALS 274>275

	Cód.	Desc.	€
	2106.706	SUPORTE PORTA TABULEIROS AÇO INOX MOD 416/616/1016	1.118,00
	2106.708	KIT DE SOBREPOSIÇÃO EM AÇO INOX MOD 416/616/1016	796,00
	2106.710	ESTUFA ELET UDEAPT1064 10T 60x40 MOD.UDFS416/6	3.017,00
	2106.711	ESTUFA ELET UDEAPT1064 10T 60x40 MOD.UDFBM-TS416/6	3.560,00
	2106.712	CHAMINE MOTORIZADA CONDENSADOS MODELO UDFS416	2.195,00
	2106.714	CHAMINE MOTORIZADA CONDENDADOS MODELO UDFS616/1016	2.195,00
	2106.716	CHAMINE MOTORIZADA CONDENSADOS MOD UDFBM416/UDFTS4	2.195,00
	2106.718	CHAMINE MOTORIZADA CONDENSADOS MOD UDFBM-T616/1016	2.195,00



UDI

NOVO  
NOUVEAU  
NUEVO  
NEW



sob pedido  
sur demande  
a pedido  
on request







**FORNOS UDF - ACESSÓRIOS E OPCIONAIS**

FOURS UDF - ACCESSOIRES ET OPTIONNELS

HORNOS UDF - ACCESORIOS Y OPCIONALES

OVENS UDF - OPTIONALS AND SPARE PARTS



	Cód.	Desc.	€
	2106.720	CHAMINE MOTORIZADA CONDENSADOS UDFTS1664/UDFBM2011	2.764,00
	2106.722	CHUVEIRO EXTERNO MODELOS 416/616/1016/1664/2011	411,00
	2106.724	SISTEMA AUTOMATICO LAVAGEM UDFBM/TS416/616/1016	934,00
	2106.726	SONDA AO CENTRO MODELOS UDFBM-TS416/616/1016/1664	365,00
	2106.728	CARRO CARRELADO EXTRAIVEL 20x1/1GN MODELOS 2011	4.307,00
	2106.730	CARRO CARRELADO EXTRAIVEL 16x(60x40) MODELOS 1664	4.065,00
	2106.732	GRELHA INOX AISI 304 P/ASSAR VERTICAL 8 FRANGOS	158,00
	2106.734	TABULEIRO INOX AISI 304 1/1GN RECOLHA-GORDURAS	64,00



MODELO / MODÈLE / MODELO / MODEL	FMG06G DG - GÁS	
CÓDIGO / CODE / CÓDIGO / CODE	2183.037	
<b>Preço / Prix / Precio / Price</b>	<b>€</b>	<b>8.954,00</b>
Dimensões / Dimensions / Dimensiones	mm	920X780X770
Capacidade da câmara / Chambre capacité / Capacidad cámara / Chamber capacity	Gn`s	6x GN 1/1
Potência Térmica Nominal/ Puissance Thermique Nominale/ Potência Térmica Nominal/ Nominal Thermal Power	kW/ Kcal	18,5/15900
Peso Líquido-Bruto /Poids Net-Brut /Peso Neto-Bruto /Net-Gross Weight	Kg	140
Tensão / Tension / Tensión / Tension	V	230



MODELO / MODÈLE / MODELO / MODEL	XAMG20D - GÁS	
CÓDIGO / CODE / CÓDIGO / CODE	2128.978	
<b>Preço / Prix / Precio / Price</b>	<b>€</b>	<b>15.052,00</b>
Dimensões / Dimensions / Dimensiones	mm	1030x980x1010
Capacidade da câmara / Chambre capacité / Capacidad cámara / Chamber capacity	Gn`s	10X GN2/1
Espaço entre as prateleiras / Espace entre étagères / Espacio entre las estanterías / Space between shelves	mm	70
Potência Térmica Nominal/ Puissance Thermique Nominale/ Potência Térmica Nominal/ Nominal Thermal Power	kW/ Kcal	27/23220
Peso Líquido-Bruto /Poids Net-Brut /Peso Neto-Bruto /Net-Gross Weight	Kg	220
Tensão / Tension / Tensión / Tension	V	230



MODELO / MODÈLE / MODELO / MODEL	FGM110 - GÁS-ELETRON-VAP. IND.	
CÓDIGO / CODE / CÓDIGO / CODE	2129.232	
<b>Preço / Prix / Precio / Price</b>	<b>€</b>	<b>10.946,00</b>
Dimensões / Dimensions / Dimensiones	mm	940x900x1050
Capacidade da câmara / Chambre capacité / Capacidad cámara / Chamber capacity	Gn`s	10X GN1/1
Espaço entre as prateleiras / Espace entre étagères / Espacio entre las estanterías / Space between shelves	mm	60
Potência Térmica Nominal/ Puissance Thermique Nominale/ Potência Térmica Nominal/ Nominal Thermal Power	kW/ Kcal	2,90/2160
Potência Total / Puissance Total / Potencia Total / Total Power	kW	0,6
Peso Líquido-Bruto /Poids Net-Brut /Peso Neto-Bruto /Net-Gross Weight	Kg	190-230
Tensão / Tension / Tensión / Tension	V	230



MODELO / MODÈLE / MODELO / MODEL	FEM110 - ELETRON-VAPOR IND.	
CÓDIGO / CODE / CÓDIGO / CODE	2129.238	
<b>Preço / Prix / Precio / Price</b>	<b>€</b>	<b>11.310,00</b>
Dimensões / Dimensions / Dimensiones	mm	940x900x1050
Capacidade da câmara / Chambre capacité / Capacidad cámara / Chamber capacity	Gn`s	640x420x670
Espaço entre as prateleiras / Espace entre étagères / Espacio entre las estanterías / Space between shelves	mm	60
Potência Total / Puissance Total / Potencia Total / Total Power	kW	15,6
Peso Líquido-Bruto /Poids Net-Brut /Peso Neto-Bruto /Net-Gross Weight	Kg	205
Tensão / Tension / Tensión / Tension	V	400



UDI

**FRITADEIRAS ELÉTRICAS BANCADA**  
FRITEUSES - ÉLECTRIQUES DE GRADIN  
FREIDORAS - ELÉCTRICAS DE SOBREMESA  
FRYERS - ELECTRIC COUNTERTOP



Dotadas de uma ampla cuba moldada e arredondada e de resistências especiais de aço inox de alta duração. Termostatos de regulação e segurança, cabeça removível para fácil limpeza, micro interruptor de segurança.



Doté d'une grande cuve moulé et arrondie et des résistances spéciales en acier inoxydable à haute durée. Thermostats de régulation et de sécurité, tête amovible pour un nettoyage facile, micro interrupteur de sécurité.



Dotadas de una amplia cuba moldeada y redondeada y resistencias especiales de acero inoxidable de alta duración. Termostatos de regulación y de seguridad, cabeza desmontable para una fácil limpieza, micro interruptor de seguridad.



Equipped with a wide, rounded shaped vat and special stainless steel heating elements of high duration. Regulation and safety thermostats, removable head for easy cleaning, safety micro switch.



#### SIMPLES / SIMPLE / SIMPLE / SIMPLE

MODELO / MODÈLE / MODELO / MODEL	FRE6	FRE9	FRE9	FRE12
CÓDIGO / CODE / CÓDIGO / CODE	2129.906	2129.908	2129.910	2129.912
Preço / Prix / Precio / Price	€ 698,00	782,00	926,00	1.052,00
Dimensões / Dimensions / Dimensiones / Dimensions	mm 290x520x295/435	290x585x295/435	290x585x295/435	375x690x310/450
Capacidade / Capacité / Capacidad / Capacity	lt 5/6	8/9	8/9	10/12
Dim. Cesto / Dim. Panier/ Dim. Cesta / Basket Dim.	mm -	-	-	-
Peso Líquido / Poids Net / Peso Neto / Net Weight	kg 11	12	13	18
Potência / Puissance / Potencia / Power	kW 3	3	6	9
Tensão / Tension / Tensión / Tension	V 230	230	400	400



#### DUPLAS / DOUBLES / DOBLES / DOUBLES

MODELO / MODÈLE / MODELO / MODEL	FRE6+6	FRE9+9	FRE12+12
CÓDIGO / CODE / CÓDIGO / CODE	2129.914	2129.916	2129.918
Preço / Prix / Precio / Price	€ 1.296,00	1.642,00	1.798,00
Dimensões / Dimensions / Dimensiones / Dimensions	mm 583x555x295/435	580x585x295/435	750x690x310/450
Capacidade / Capacité / Capacidad / Capacity	lt 5/6+5/6	8/9+8/9	10/12+10/12
Dim. Cesto / Dim. Panier/ Dim. Cesta / Basket Dim.	mm -	190x240x100	235x285x110
Peso Líquido / Poids Net / Peso Neto / Net Weight	kg 19	20	32
Potência / Puissance / Potencia / Power	kW 3+3	6+6	9+9
Tensão / Tension / Tensión / Tension	V 230	400	400

Dimensão de profundidade inclui torneira  
La profondeur comprend le robinet  
Dimensión de profundidad incluye grifo  
Depth dimension includes faucet

Panel sujeito a alterações | Panneau objet de modifications | Panel sujeto a cambio | Panel subject to change.



Uma linha única de fritadeiras a gás com a menor fritadeira a gás do mundo (RFG 8), ideal para rolotes de comida, mercados e pontos de venda com consumo elétrico limitado.

- Iluminação piezoelétrica e queimador piloto.
  - Tubo posterior para saída de gás.
  - Suporte de cesto filtrante para grandes restos fritos ou para fritar rosquinhas ou pedaços grandes sem cesto.
- Limpeza: dispositivo de drenagem de segurança em aço inoxidável. Tanque estampado e levemente inclinado sem nenhum resíduo de óleo. Exclusivo sistema de remoção de queimadores em caso de intervenção técnica.
- Características: Iluminação piezoelétrica, botão de regulação, queimador de alta potência por baixo do depósito, depósito em inox isolado com nível de óleo mini/maxi, tampa em inox.
- Fornecido em GLP com conjunto de injetores de GN.



Une gamme unique de friteuses gaz avec la plus petite friteuse gaz au monde (RFG 8), idéale pour les camions de nourriture, marchés et points de vente avec une consommation électrique limitée.

- Éclairage piezo et veilleuse.
  - Tuyau arrière pour sortie de gaz.
  - Porte-panier filtrant pour gros restes frits ou pour la friture de beignets ou de gros morceaux sans panier.
- Nettoyage : dispositif de vidange de sécurité en acier inoxydable. Réservoir embouti et légèrement incliné sans aucun résidu d'huile. Système exclusif de retrait des brûleurs en cas d'intervention technique.
- Caractéristiques : Eclairage piezo, bouton de réglage, brûleur haute puissance sous la cuve, cuve inox isolée avec niveau d'huile mini/maxi, couvercle inox.
- Livré en GPL avec un jeu d'injecteurs NG.



Una gama única de freidoras a gas con la freidora a gas más pequeña del mundo (RFG 8), ideal para camiones de comida, mercados y puntos de venta con un consumo eléctrico limitado.

- Encendido piezoeléctrico y quemador piloto.
  - Tubo trasero para salida de gas.
  - Soporte cesta filtrante para grandes restos de fritos o para la fritura de rosquillas o piezas grandes sin cesta.
- Limpeza: dispositivo de drenaje de seguridad de acero inoxidable. Depósito estampado y ligeramente inclinado sin restos de aceite. Exclusivo sistema de extracción de quemadores en caso de intervención técnica.
- Características: Iluminación piezoelétrica, perilla de regulación, quemador de alta potencia debajo del tanque, tanque de acero inoxidable aislado con nivel de aceite mini/maxi, tapa de acero inoxidable. Se suministra en GLP con juego de inyectores GN.



A unique range of gas fryers with the smallest gas fryer in the world (RFG 8), ideal for foodtrucks, markets and point of sales with a limited electric consumption.

- Piezo lighting and pilot burner.
  - Back pipe for gas exit.
  - Filtering basket holder for big fried rests or for the frying of doughnuts or large pieces without any basket.
- Cleaning: stainless steel safety draining device. Stamped and slightly tilted tank without any oil residue. Exclusive removal system of burners in case of technical intervention.
- Features: Piezo lighting, regulation knob, high power burner under the tank, insulated stainless steel tank with oil level mini/maxi, stainless steel lid. Supplied in LPG with a set of NG injectors.



**NOVO  
NOUVEAU  
NUEVO  
NEW**



MODELO / MODÈLE / MODELO / MODEL	RFG8
CÓDIGO / CODE / CÓDIGO / CODE	2230.382
Preço / Prix / Precio / Price	€ 1.494,00
Dimensões / Dimensions / Dimensiones	mm 250 x 700 x 325
Dim. Cesto / Dim. Panier/ Dim. Cesta / Basket Dim.	mm 128 x 270 x 110
Capacidade / Capacite / Capacidad / Capacity	lt 8
Peso Líquido / Poids Net / Peso Neto / Net Weight	kg 25
Potência / Puissance / Potencia / Power	kW 4
Rendimento / Rendiment / Rendimiento / Output	kg/h 13

**NOVO  
NOUVEAU  
NUEVO  
NEW**



MODELO / MODÈLE / MODELO / MODEL	RFG12
CÓDIGO / CODE / CÓDIGO / CODE	2230.384
Preço / Prix / Precio / Price	€ 1.979,00
Dimensões / Dimensions / Dimensiones	mm 400x700x510
Dim. Cesto / Dim. Panier/ Dim. Cesta / Basket Dim.	mm 250x270x110
Capacidade / Capacite / Capacidad / Capacity	lt 12
Peso Líquido / Poids Net / Peso Neto / Net Weight	kg 34
Potência / Puissance / Potencia / Power	kW 8
Rendimento / Rendiment / Rendimiento / Output	kg/h 18



confirmar disponibilidade  
confirmer la disponibilité  
confirmar la disponibilidad  
confirm the availability

**FRITADEIRAS ELÉTRICAS BANCADA**  
FRITEUSES ÉLECTRIQUES DE GRADIN  
FREIDORAS ELÉCTRICAS DE SOBREMESA  
ELECTRIC FRYERS COUNTERTOP



Dotadas de uma ampla cuba moldada e arredondada e de resistências especiais de aço inox de alta duração. Termostatos de regulação e segurança, cabeça removível para fácil limpeza, micro interruptor de segurança.  
UFRI7LTS e UFRI2X7LTS tem contactor.



Dotadas de una amplia cuba moldeada y redondeada y resistencias especiales de acero inoxidable de alta duración. Termostatos de regulación y de seguridad, cabeza desmontable para una fácil limpieza, micro interruptor de seguridad.  
UFRI7LTS y UFRI2X7LTS con contactor.



Doté d'une grande cuve moulé et arrondie et des résistances spéciales en acier inoxydable à haute durée. Thermostats de régulation et de sécurité, tête amovible pour un nettoyage facile, micro interrupteur de sécurité.  
UFRI7LTS et UFRI2X7LTS avec contacteur.



Equipped with a wide, rounded shaped vat and special stainless steel heating elements of high duration. Regulation and safety thermostats, removable head for easy cleaning, safety micro switch.  
UFRI7LTS and UFRI2X7LTS with contactor.



MODELO / MODÈLE / MODELO / MODEL CÓDIGO / CODE / CÓDIGO / CODE	UFRI7LTS 3010.110
<b>Preço / Prix / Precio / Price</b>	<b>€ 313,00</b>
Dimensões / Dimensions / Dimensiones	mm 290X410X290
Capacidade / Capacite / Capacidad / Capacity	lt 7
Largura Cesto / Largeur Panier/ Ancho Cesta / Basket Width	mm 190
Profundidade Cesto / Profondeur Panier / Profundidad Cesta / Basket Depth	mm 220
Altura Cesto / Hauteur Panier / Altura Cesta / Basket Height	mm 110
Peso Líquido / Poids Net / Peso Neto / Net Weight	kg 6
Potência / Puissance / Potencia / Power	kW 3,5
Tensão / Tension / Tensión / Tension	V 230



MODELO / MODÈLE / MODELO / MODEL CÓDIGO / CODE / CÓDIGO / CODE	UFRI2X7LTS 3010.112
<b>Preço / Prix / Precio / Price</b>	<b>€ 595,00</b>
Dimensões / Dimensions / Dimensiones	mm 560X460X370
Capacidade / Capacite / Capacidad / Capacity	lt 2x7
Largura Cesto / Largeur Panier/ Ancho Cesta / Basket Width	mm 190
Profundidade Cesto / Profondeur Panier / Profundidad Cesta / Basket Depth	mm 220
Altura Cesto / Hauteur Panier / Altura Cesta / Basket Height	mm 110
Peso Líquido / Poids Net / Peso Neto / Net Weight	kg 13
Potência / Puissance / Potencia / Power	kW 2x3,5
Tensão / Tension / Tensión / Tension	V 230





MODELO / MODÈLE / MODELO / MODEL CÓDIGO / CODE / CÓDIGO / CODE	UFRI 8 400V 3010.022	UFRI 10 230V 3010.018
<b>Preço / Prix / Precio / Price</b>	<b>€ 561,00</b>	<b>578,00</b>
Dimensões / Dimensions / Dimensiones	mm 290x460x370	325x495x370
Capacidade / Capacite / Capacidad / Capacity	lt 7	10
Largura Cesto / Largeur Panier/ Ancho Cesta / Basket Width	mm 220	255
Profundidade Cesto / Profondeur Panier / Profundidad Cesta / Basket Depth	mm 190	255
Altura Cesto / Hauteur Panier / Altura Cesta / Basket Height	mm 110	110
Peso Líquido / Poids Net / Peso Neto / Net Weight	kg 7	9
Potência / Puissance / Potencia / Power	kW 4,5	4,5
Tensão / Tension / Tensión / Tension	V 400	230





MODELO / MODÈLE / MODELO / MODEL CÓDIGO / CODE / CÓDIGO / CODE	UFRI 8+8 400V 3010.024	UFRI 10+10 230V 3010.020	UFRI 10+10 400V 3010.032
<b>Preço / Prix / Precio / Price</b>	<b>€ 1.099,00</b>	<b>1.049,00</b>	<b>1.487,00</b>
Dimensões / Dimensions / Dimensiones	mm 560x460x370	653x495x370	653x495x370
Capacidade / Capacite / Capacidad / Capacity	lt 2x7	2x10	2x10
Largura Cesto / Largeur Panier/ Ancho Cesta / Basket Width	mm 220	255	255
Profundidade Cesto / Profondeur Panier / Profundidad Cesta / Basket Depth	mm 190	255	255
Altura Cesto / Hauteur Panier / Altura Cesta / Basket Height	mm 110	110	110
Peso Líquido / Poids Net / Peso Neto / Net Weight	kg 13	17	16
Potência / Puissance / Potencia / Power	kW 2x4,5	2x4,5	2x8,5
Tensão / Tension / Tensión / Tension	V 400	230	400

Panel sujeito a alterações | Panneau objet de modifications | Panel sujeto a cambio | Panel subject to change.

 Linha de móvel de rendimento melhorado, dotadas de uma ampla cuba arredondada e de resistências especiais de aço inox de alta duração. Termostatos de regulação e segurança, cabeça removível para fácil limpeza, micro interruptor de segurança. Cada modelo inclui uma cuba de filtragem de óleo.

 Línea de mueble rendimiento mejorado, dotadas de una amplia cuba moldeada y redondeada y resistencias especiales de acero inoxidable de alta duración. Termostatos de regulación y de seguridad, cabeza desmontable para una fácil limpieza, micro interruptor de seguridad. Cada modelo incluye un tanque de filtración de aceite.

 Ligne de meuble de rendement amélioré, doté d'une grande cuve moulée et arrondie et des résistances spéciales en acier inoxydable à haute durée. Thermostats de régulation et de sécurité, tête amovible pour un nettoyage facile, micro interrupteur de sécurité. Chaque modèle comprend une cuve de filtrage d'huile.

 Cabinet line of improved performance, equipped with a wide, rounded shaped vat and special stainless steel heating elements of high duration. Regulation and safety thermostats, removable head for easy cleaning, safety micro switch. Each model includes an oil filtering tank.



MODELO / MODÈLE / MODELO / MODEL		FME15	FME20
CÓDIGO / CODE / CÓDIGO / CODE		2129.920	2129.922
<b>Preço / Prix / Precio / Price</b>	<b>€</b>	<b>1.270,00</b>	<b>1.386,00</b>
Dimensões / Dimensions / Dimensiones	mm	375x 655x 845/985	375x 755x 845/985
Capacidade / Capacité / Capacidad / Capacity	lt	12/14	18/20
Dimensão cesto / Dim. panier / Dim. cesta / Basket dim.		235x275x105	235x385x105
Peso Líquido / Poids Net / Peso Neto / Net Weight	kg	29	32
Potência / Puissance / Potencia / Power	kW	9	12
Tensão / Tension / Tensión / Tension	V	400	400



MODELO / MODÈLE / MODELO / MODEL		FME30	FME40
CÓDIGO / CODE / CÓDIGO / CODE		2129.924	2129.926
<b>Preço / Prix / Precio / Price</b>	<b>€</b>	<b>2.306,00</b>	<b>2.570,00</b>
Dimensões / Dimensions / Dimensiones	mm	750x 655x 845/985	750x 755x 845/985
Capacidade / Capacité / Capacidad / Capacity	lt	12/14+12/14	18/20+18/20
Dimensão cesto / Dim. panier / Dim. cesta / Basket dim.		235x275x105	235x385x105
Peso Líquido / Poids Net / Peso Neto / Net Weight	kg	55	60
Potência / Puissance / Potencia / Power	kW	9+9	12+12
Tensão / Tension / Tensión / Tension	V	400	400

Painel sujeito a alterações | Panneau objet de modifications | Panel sujeto a cambio | Panel subject to change.





UDI

**FRITADEIRAS GÁS MÓVEL**  
FRITEUSES GAZ MEUBLE  
FREIDORAS GAS MUEBLE  
FRYERS-GAS CUPBOARD



Linha de móvel, dotada de amplas cubas de aço inox.  
Acendimento piezoelétrico com piloto, termopar, termostatos de segurança e de regulação de 90 a 190° C.  
Dispositivos de utilização, inseridos no interior do móvel, garantindo a protecção dos mesmos. Cada modelo inclui uma cuba de filtragem de óleo.



Línea de mueble doté de cubas grandes en acero inoxidable.  
Encendido piezoeléctrico con piloto, termopar, termostatos de seguridad y regulación de 90°-190 ° C.  
Dispositivos de utilización, integrado en el interior del mueble, lo que garantiza la protección de los mismos. Cada modelo incluye un tanque de filtración de aceite.



Ligne de meuble doté de cuves grandes en acier inoxydable.  
Allumage piézoélectrique avec pilote, thermocouple, thermostats de sécurité et régulation de 90°-190 ° C.  
Dispositifs de utilisation, inséré dans le intérieur du meuble, assurer la protection de celui-ci. Chaque modèle comprend une cuve de filtrage d'huile.



Cabinet line equipped with large stainless steel vats.  
Piezoelectric ignition with pilot, thermocouple, safety and regulation thermostats of 90°-190 ° C.  
Using devices, inserted into the cabinet, ensuring the protection thereof.  
Each model includes an oil filtering tank.

## GPL

ready



MODELO / MODÈLE / MODELO / MODEL CÓDIGO / CODE / CÓDIGO / CODE		FMG15 2129.928	FMG20 2129.930
<b>Preço/ Prix / Precio / Price</b>	€	<b>1.982,00</b>	<b>2.138,00</b>
Dimensões / Dimensions / Dimensiones	mm	375x650x1100	375x750x1100
Capacidade / Capacité / Capacidad / Capacity	lt	14	17,5
Dimensão cesto / Dim. panier / Dim. cesta / Basket dim.	mm	235x275x105	235x385x105
Consumo de Gás G20 / Consommation Gaz G20 / Consumo Gas G20 / Gas Consumption G20	m <sup>3</sup> /h	1,20	1,32
Consumo de Gás G30-G31 / Consommation Gaz G30-G31 / Consumo Gas G30-G31 / Gas Consumption G30-G31	kg/h	0,47	0,52
Potência / Puissance / Potencia / Power	Qn(kW)	13	14
Peso Líquido / Poids Net / Peso Neto / Net Weight	kg	44	47



MODELO / MODÈLE / MODELO / MODEL CÓDIGO / CODE / CÓDIGO / CODE		FMG30 2129.932	FMG40 2129.934
<b>Preço/ Prix / Precio / Price</b>	€	<b>3.338,00</b>	<b>3.776,00</b>
Dimensões / Dimensions / Dimensiones	mm	750x650x1100	750x750x1100
Capacidade / Capacité / Capacidad / Capacity	lt	14+14	17,5+17,5
Dimensão cesto / Dim. panier / Dim. cesta / Basket dim.	mm	235x275x105	235x385x105
Consumo de Gás G20 / Consommation Gaz G20 / Consumo Gas G20 / Gas Consumption G20	m <sup>3</sup> /h	2,40	2,65
Consumo de Gás G30-G31 / Consommation Gaz G30-G31 / Consumo Gas G30-G31 / Gas Consumption G30-G31	kg/h	0,95	1,05
Potência / Puissance / Potencia / Power	Qn(kW)	13+13	14+14
Peso Líquido / Poids Net / Peso Neto / Net Weight	kg	81	86

Panel sujeito a alterações | Panneau objet de modifications | Panel sujeto a cambio | Panel subject to change.



Linha elétrica de bancada para pastelaria, dotada de amplas cubas e cestos de aço inox, de rendimento melhorado, com resistências especiais de aço inox de alta duração. Termostatos de regulação e segurança, cabeça removível para fácil limpeza, micro interruptor de segurança. Linha a gás de bancada e de móvel para pastelaria, acendimento piezoelétrico com piloto, termopar, termostatos de segurança e de regulação de 90 a 190° C. Todos os modelos com torneira frontal para fácil descarga de óleo.



Línea eléctrica de mueble para pastelaría, dotada de amplias cubas y cestas de acero inoxidable, de rendimiento mejorado, con resistencias especiales de acero inoxidable de alta duración. Termostatos de regulación y de seguridad, cabeza desmontable para una fácil limpieza, micro interruptor de seguridad. Línea a gas de mueble para pastelaría, encendido piezoeléctrico con piloto, termopar, termostatos de seguridad y regulación de 90°-190 ° C. Todos los modelos con grifo frontal para descarga fácil de aceite.



Ligne électrique de gradin pour pâtisserie, doté de grandes cuves et des paniers en acier inoxydable, de rendement amélioré, avec résistances spéciales en acier inoxydable à haute durée. Thermostats de régulation et de sécurité, tête amovible pour un nettoyage facile, micro interrupteur de sécurité. Ligne a gaz de gradin et meuble pour pâtisserie, allumage piézoélectrique avec pilote, thermocouple, thermostats de sécurité et régulation de 90°-190 ° C. Tous les modèles avec robinet avant pour le décharge d'huile.



Electric cabinet line for pastry, equipped with large vats and baskets of stainless steel, improved performance, with special stainless steel heating elements of high duration. Regulation and safety thermostats, removable head for easy cleaning, safety micro switch. Gas cabinet line for pastry, piezoelectric ignition with pilot, thermocouple, safety and regulation thermostats of 90°-190 ° C. All models with front tap for easy oil discharge.



MODELO / MODÈLE / MODELO / MODEL		UFRP-16	UFRP-30
CÓDIGO / CODE / CÓDIGO / CODE		3010.038	3010.040
<b>Preço/ Prix / Precio / Price</b>	€	<b>1.016,00</b>	<b>1.596,00</b>
Dimensões / Dimensions / Dimensiones	mm	530x460x370	665x650x370
Capacidade / Capacite / Capacidad/ Capacity	lt	16	30
Dimensão cesto / Dim. panier / Dim. cesta / Basket dim.	mm	465x225x105	570x415x105
Peso Bruto / Poids Brut / Peso Bruto / Gross Weight	kg	12	20
Potência / Puissance / Potencia / Power	kW	9	15
Tensão / Tension / Tensión / Tension	V	400	400



MODELO / MODÈLE / MODELO / MODEL		FRE-20P	FRE-40P
CÓDIGO / CODE / CÓDIGO / CODE		2129.902	2129.904
<b>Preço/ Prix / Precio / Price</b>	€	<b>1.548,00</b>	<b>2.085,00</b>
Dimensões / Dimensions / Dimensiones	mm	750x675x260	750x775x260
Capacidade / Capacite / Capacidad/ Capacity	lt	18/20	34/37
Dimensão cesto / Dim. panier / Dim. cesta / Basket dim.	mm	560x275x105	600x400x105
Peso Bruto / Poids Brut / Peso Bruto / Gross Weight	kg	24	29
Potência / Puissance / Potencia / Power	kW	9	9
Tensão / Tension / Tensión / Tension	V	400	400



MODELO / MODÈLE / MODELO / MODEL		GL30B
CÓDIGO / CODE / CÓDIGO / CODE		2083.508A
<b>Preço/ Prix / Precio / Price</b>	€	<b>2.468,00</b>
Dimensões / Dimensions / Dimensiones	mm	800x700x290
Capacidade / Capacite / Capacidad/ Capacity	lt	25
Dimensão cesto / Dim. panier / Dim. cesta / Basket dim.	mm	610x300x115
Consumo de Gás G20 / Consommation Gaz G20 / Consumo Gas G20 / Gas Consumption G20	m <sup>3</sup> /h	2,12
Consumo de Gás G30-G31 / Consommation Gaz G30-G31 Consumo Gas G30-G31 / Gas Consumption G30-G31	m <sup>3</sup> /h	1,58
Potência queimadores / Puissance brûleurs / Potencia fuegos / Power burners	Qn(kW)	20
Prod. Máx / Prod. Max / Prod. Máx / Max Prod.	Kg/h	48
Peso Bruto / Poids Brut / Peso Bruto / Gross Weight	kg	60
Potência / Puissance / Potencia / Power	kW	20



elétrico  
électrique  
eléctrico  
electric



gás  
gaz  
gas  
gas



bancada  
plain de travail  
encimera  
worktop



confirmar disponibilidade  
confirmer la disponibilité  
confirmar la disponibilidad  
confirm the availability



UDI

**FRITADEIRAS DE ALTO RENDIMENTO**  
FRITEUSES HAUTE PERFORMANCE  
FREIDORAS DE ALTO RENDIMIENTO  
HIGH PERFORMANCE FRYERS



Estrutura em aço inox AISI 304 com painéis extraíveis  
Painel electrónico LCD "Easytouch" com controle simples e imediato das seguintes funções: 12 ciclos de cozedura personalizada  
Memorização do ciclo precedente  
Ciclo "Melting" automático controlado na fase inicial  
ciclo automático de lavagem da cuba  
Sistema de autodiagnóstico  
Inclui 2 cestos; Modelos AC **com levantamento automático do cesto**



Estructura de acero inoxidable AISI 304 con paneles extraíbles  
Panel LCD "Easytouch" con control simple e inmediato de las siguientes funciones: 12 ciclos de cocción personalizada  
Memorización del ciclo precedente  
Ciclo "Melting" automático controlado en la fase inicial  
ciclo automático de lavado de la cuba  
Sistema de autodiagnóstico  
Incluye 2 cestas; Modelos AC **con levantamiento automático de la cesta**



Cadre en acier inoxydable AISI 304 avec panneaux amovibles  
Panneau LCD électronique "Easytouch" avec contrôle simple et immédiat des fonctions suivantes: 12 cycles de cuisson personnalisée  
Mémorisation du cycle précédent  
Cycle de fusion automatique contrôlé dans la phase initiale  
cycle de lavage automatique du réservoir  
Système d'autodiagnostic  
Inclus 2 paniers; Modèles AC **avec soulèvement automatique du panier**



AISI 304 stainless steel frame with removable panels  
Electronic LCD panel "Easytouch" with simple and immediate control of the following functions: 12 cycles of personalized cooking  
Memorizing the previous cycle  
Melting cycle automatic controlled in the initial phase  
automatic washing cycle of the tank  
Self-diagnosis system  
Included 2 baskets; AC models **with automatic basket lifting**



opcional  
optionnel  
opcional  
optional

Cód.	Ref.	Dimens.	€
3800.350	Cesto / Basket	365x300x130	272,00



MODELO / MODÈLE / MODELO / MODEL	UDIEFP25AC	UDIGFP25AC	UDIEFU25AC	UDIGFU25AC
CÓDIGO / CODE / CÓDIGO / CODE	3800.306	3800.314	3800.308	3800.316
Preço / Prix / Precio / Price	€ 6.905,00	8.193,00	7.182,00	8.610,00
Dimensões / Dimensions / Dimensiones	mm 400x 800x 1260	400x 800x 1260	400x 900x 1260	400x 900x 1260
Capacidade / Capacite / Capacidad / Capacity	lt 25	25	25	25
Dimensão cesto / Dim. panier / Dim. cesta / Basket dim.	mm 140x 365x 130	140x 365x 130	140x 365x 130	140x 365x 130
Produção Batatas Cong./ Production Frites Surgeles / Producción Patata Cong./Frozen Potato Production	kg/h ~35	~30	~35	~30
Peso Bruto / Poids Brut / Peso Bruto / Gross Weight	kg 75	92	75	92
Potência / Puissance / Potencia / Power	kW 6,6-13,2-20	9~25	6,6-13,2-20	9~25
Tensão / Tension / Tensión / Tension	V 400	230	400	230



elétrico  
électrique  
eléctrico  
electric



gás  
gaz  
gas  
gas

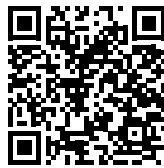

**NOVO**  
**NOUVEAU**  
**NUEVO**  
**NEW**



MODELO / MODÈLE / MODELO / MODEL	NEFEP9122
CÓDIGO / CODE / CÓDIGO / CODE	3901.716
<b>Preço / Prix / Precio / Price</b>	<b>€ 5.948,00</b>
Dimensões / Dimensions / Dimensiones	mm 400x900x900
Capacidade / Capacité / Capacidad / Capacity	lt 22
Dimensão cesto / Dim. panier / Dim. cesta / Basket dim.	mm 240x420x180
Produção Batatas Cong./ Production Frites Surgeles /Producción Patata Cong. /Frozen Potato Production	kg/h -
Peso Bruto / Poids Brut / Peso Bruto / Gross Weight	kg 81/-
Potência / Puissance / Potencia / Power	kW 22
Tensão / Tension / Tensión / Tension	V 400

**NOVO**  
**NOUVEAU**  
**NUEVO**  
**NEW**



**Levantamento automático do cesto / Relevage automatique des paniers**

Elevación automática de cestas / Automatic basket lifting

MODELO / MODÈLE / MODELO / MODEL	NEFEP9122A
CÓDIGO / CODE / CÓDIGO / CODE	3901.720
<b>Preço / Prix / Precio / Price</b>	<b>€ 9.019,00</b>
Dimensões / Dimensions / Dimensiones	mm 400x900x900
Capacidade / Capacité / Capacidad / Capacity	lt 22
Dimensão cesto / Dim. panier / Dim. cesta / Basket dim.	mm 240x420x180
Produção Batatas Cong./ Production Frites Surgeles /Producción Patata Cong. /Frozen Potato Production	kg/h -
Peso Bruto / Poids Brut / Peso Bruto / Gross Weight	kg 81/-
Potência / Puissance / Potencia / Power	kW 22
Tensão / Tension / Tensión / Tension	V 400

**NOVO**  
**NOUVEAU**  
**NUEVO**  
**NEW**



**Filtragem automática do óleo / Filtration automatique de l'huile**

Filtración automática de aceite / Automatic oil filtering

MODELO / MODÈLE / MODELO / MODEL	NEFEP9122F
CÓDIGO / CODE / CÓDIGO / CODE	3901.726
<b>Preço / Prix / Precio / Price</b>	<b>€ 10.400,00</b>
Dimensões / Dimensions / Dimensiones	mm 400x900x900
Capacidade / Capacité / Capacidad / Capacity	lt 22
Dimensão cesto / Dim. panier / Dim. cesta / Basket dim.	mm 240x420x180
Produção Batatas Cong./ Production Frites Surgeles /Producción Patata Cong. /Frozen Potato Production	kg/h -
Peso Bruto / Poids Brut / Peso Bruto / Gross Weight	kg 94/-
Potência / Puissance / Potencia / Power	kW 22
Tensão / Tension / Tensión / Tension	V 400

**NOVO**  
**NOUVEAU**  
**NUEVO**  
**NEW**



**Levantamento automático do cesto / Relevage automatique des paniers**

Elevación automática de cestas / Automatic basket lifting

**Filtragem automática do óleo / Filtration automatique de l'huile**

Filtración automática de aceite / Automatic oil filtering

MODELO / MODÈLE / MODELO / MODEL	NEFEP9122FA
CÓDIGO / CODE / CÓDIGO / CODE	3901.730
<b>Preço / Prix / Precio / Price</b>	<b>€ 12.734,00</b>
Dimensões / Dimensions / Dimensiones	mm 400x900x900
Capacidade / Capacité / Capacidad / Capacity	lt 22
Dimensão cesto / Dim. panier / Dim. cesta / Basket dim.	mm 240x420x180
Produção Batatas Cong./ Production Frites Surgeles /Producción Patata Cong. /Frozen Potato Production	kg/h -
Peso Bruto / Poids Brut / Peso Bruto / Gross Weight	kg 104/-
Potência / Puissance / Potencia / Power	kW 22
Tensão / Tension / Tensión / Tension	V 400



elétrico  
électrique  
eléctrico  
electric



# SILKO

**FRITADEIRAS DE ALTO RENDIMENTO**  
FRITEUSES HAUTE PERFORMANCE  
FREIDORAS DE ALTO RENDIMIENTO  
HIGH PERFORMANCE FRYERS



**NOVO**  
**NOUVEAU**  
**NUEVO**  
**NEW**



MODELO / MODÈLE / MODELO / MODEL	NEFGP9123
CÓDIGO / CODE / CÓDIGO / CODE	3901.734
<b>Preço / Prix / Precio / Price</b>	<b>€ 7.874,00</b>
Dimensões / Dimensions / Dimensiones	mm 400x900x900
Capacidade / Capacité / Capacidad / Capacity	lt 23
Dimensão cesto / Dim. panier / Dim. cesta / Basket dim.	mm 340x420x200
Produção Batatas Cong./ Production Frites Surgeles /Producción Patata Cong. /Frozen Potato Production	kg/h -
Peso Bruto / Poids Brut / Peso Bruto / Gross Weight	kg -87
Potência / Puissance / Potencia / Power	kW 0,1
Tensão / Tension / Tensión / Tension	V 230

**NOVO**  
**NOUVEAU**  
**NUEVO**  
**NEW**



**Levantamento automático do cesto / Relevage automatique des paniers**  
Elevación automática de cestas / Automatic basket lifting

MODELO / MODÈLE / MODELO / MODEL	NEFGP9123A
CÓDIGO / CODE / CÓDIGO / CODE	3901.738
<b>Preço / Prix / Precio / Price</b>	<b>€ 10.574,00</b>
Dimensões / Dimensions / Dimensiones	mm 400x900x900
Capacidade / Capacité / Capacidad / Capacity	lt 23
Dimensão cesto / Dim. panier / Dim. cesta / Basket dim.	mm 340x420x200
Produção Batatas Cong./ Production Frites Surgeles /Producción Patata Cong. /Frozen Potato Production	kg/h -
Peso Bruto / Poids Brut / Peso Bruto / Gross Weight	kg -111
Potência / Puissance / Potencia / Power	kW 0,1
Tensão / Tension / Tensión / Tension	V 230

**NOVO**  
**NOUVEAU**  
**NUEVO**  
**NEW**



**Filtragem automática do óleo / Filtration automatique de l'huile**  
Filtración automática de aceite / Automatic oil filtering

MODELO / MODÈLE / MODELO / MODEL	NEFGP9123F
CÓDIGO / CODE / CÓDIGO / CODE	3901.742
<b>Preço / Prix / Precio / Price</b>	<b>€ 11.890,00</b>
Dimensões / Dimensions / Dimensiones	mm 400x900x900
Capacidade / Capacité / Capacidad / Capacity	lt 23
Dimensão cesto / Dim. panier / Dim. cesta / Basket dim.	mm 340x420x200
Produção Batatas Cong./ Production Frites Surgeles /Producción Patata Cong. /Frozen Potato Production	kg/h -
Peso Bruto / Poids Brut / Peso Bruto / Gross Weight	kg -105
Potência Gás / Puissance Gaz / Potencia Gas / Gas Power	kW 25
Potência Elétrica / Puissance Electrique / Potencia Elétrica / Electric Power	kW 0,1
Tensão / Tension / Tensión / Tension	V 230

**NOVO**  
**NOUVEAU**  
**NUEVO**  
**NEW**



**Levantamento automático do cesto / Relevage automatique des paniers**  
Elevación automática de cestas / Automatic basket lifting

**Filtragem automática do óleo / Filtration automatique de l'huile**  
Filtración automática de aceite / Automatic oil filtering

MODELO / MODÈLE / MODELO / MODEL	NEFGP9123FA
CÓDIGO / CODE / CÓDIGO / CODE	3901.744
<b>Preço / Prix / Precio / Price</b>	<b>€ 14.283,00</b>
Dimensões / Dimensions / Dimensiones	mm 400x900x900
Capacidade / Capacité / Capacidad / Capacity	lt 23
Dimensão cesto / Dim. panier / Dim. cesta / Basket dim.	mm 340x420x200
Produção Batatas Cong./ Production Frites Surgeles /Producción Patata Cong. /Frozen Potato Production	kg/h -
Peso Bruto / Poids Brut / Peso Bruto / Gross Weight	kg -111
Potência Gás / Puissance Gaz / Potencia Gas / Gas Power	kW 25
Potência Elétrica / Puissance Electrique / Potencia Elétrica / Electric Power	kW 0,1
Tensão / Tension / Tensión / Tension	V 230



Carro de transporte banho-maria para 3 containers GN1/1. Containers (Altura Máxima 200mm), guías e tampas não incluídos. Saída de Água. Com 4 rodas.

Carro de transporte térmico banho maría para 3 containers GN1/1. Containers (Altura Máxima 200mm), guías y tapas no incluidos. Salida de agua. Con 4 ruedas.

Chariots de transport thermiques bain-marie pour 3 containers GN1/1. Containers (Hauteur Maximum 200mm), guides et couvercles ne sont pas inclus. Drainage d'eau. Avec 4 roues.

Water bath thermal trolleys for 3 GN1/1 containers. Containers (Maximum Height 200mm), guides and lids not included. Water Drainer. With 4 wheels.



**Algumas configurações possíveis**  
 Quelques configurations possibles  
 Algunas configuraciones posibles  
 Some possible configurations



3X GN 1/1



1X GN 1/1 +  
2x GN 1/2 + 3x GN 1/3



1X GN 1/1 +  
4xGN 1/4 + 3x GN1/3



30°- 90°



MODELO / MODÈLE / MODELO / MODEL	UDCTBM3
CÓDIGO / CODE / CÓDIGO / CODE	5700.820
<b>Preço / Prix / Precio / Price</b>	€ <b>1.824,00</b>
Dimensões / Dimensions / Dimensiones	mm 650x1100x850
Volume / Volume / Volumen / Volume	m³ 0,65
Capacidade / Capacité / Capacidad / Capacity	nr 3xGN1/1
Peso / Poids / Peso / Weight	kg 41
Potência / Puissance / Potencia / Power	kW 2

**Containers, guías e tampas não incluídos**  
**Containers, guides et couvercles ne sont pas inclus**  
**Containers, guías y tapas no incluidos**  
**Containers, guides and lids not included**

CONTAINERS E TAMPAS / BACS ET COUVERCLES / BANDEJAS Y TAPAS / CONTAINERS AND COVERS - GASTRONORM: Pág. 306



MODELO / MODÈLE / MODELO / MODEL	CCBM3 311 3 GN1/1	
CÓDIGO / CODE / CÓDIGO / CODE	2098.772	
<b>Preço / Prix / Precio / Price</b>	€	<b>2.330,00</b>
Dimensões / Dimensions / Dimensiones	mm	665x841x850
Capacidade / Capacité / Capacidad / Capacity	nr	3xGN1/1
Potência / Puissance / Potencia / Power	kW	2,1
Tensão / Tension / Tensión / Tension	V	230



MODELO / MODÈLE / MODELO / MODEL	CCBM 311 3 GN1/1	CCBM 411 4 GN1/1
CÓDIGO / CODE / CÓDIGO / CODE	2098.766	2098.768
<b>Preço / Prix / Precio / Price</b>	€ <b>1.875,00</b>	<b>2.370,00</b>
Dimensões / Dimensions / Dimensiones	mm 665x1145x850	665x1470x850
Capacidade / Capacité / Capacidad / Capacity	nr 3xGN1/1	4 GN1/1
Potência / Puissance / Potencia / Power	kW 2,1	2,1
Tensão / Tension / Tensión / Tension	V 230	230



MODELO / MODÈLE / MODELO / MODEL	UFC11	
CÓDIGO / CODE / CÓDIGO / CODE	3500.370	
<b>Preço / Prix / Precio / Price</b>	€	<b>3.629,00</b>
Dimensões / Dimensions / Dimensiones	mm	1300x680x920
Capacidade / Capacité / Capacidad / Capacity	nr	3 x GN 1/1 - 200
Potência / Puissance / Potencia / Power	kW	2,4
Tensão / Tension / Tensión / Tension	V	230



**opcional**  
 opțional  
 optional

**confirmar disponibilidade**  
 confirmer la disponibilité  
 confirmar la disponibilidad  
 confirm the availability



UDI

CARROS DE SERVIÇO HOSPITALAR

CHARIOT DE SERVICE HÔPITAL

CARRO DE SERVICIO HOSPITAL

SERVICE TROLLEYS HOSPITAL



MODELO / MODÈLE / MODELO / MODEL		AQUECIDO E 180 12X1/1 GN	AQUECIDO VENTILADO F180 12GN1/1
CÓDIGO / CODE / CÓDIGO / CODE		2134.002	2134.004
<b>Preço / Prix / Precio / Price</b>	€	<b>4.670,00</b>	<b>5.280,00</b>
Dimensões Ext. / Dimensions / Dimensiones / Dimensions	mm	525x 700x 1355	525x 770x 1355
Dimensões Int. / Dimensions / Dimensiones / Dimensions	mm	330x 540x 1000	330x 540x 1000
Potência/ Puissance/ Potencia/ Power	kW	0,8	1
Tensão/ Tension/ Tensión/ Tension	V	230	230
Capacidade Tabuleiros / Capacité Plateaux / Capacidad Bandejas / Tray capacity	nr	12x1/1 GN	12x1/1 GN
Temperatura/ Température/ Temperatura/ Temperature	°c	+30/+90	+30/+90
Espaço Entre Guias/ Espace entre les guides/	mm	80	80
Peso Bruto/ Poids Brut/	Kg	60	65



2134.010



2134.012

MODELO / MODÈLE / MODELO / MODEL		REFRIGERADO C180 12GN1/1	REFRIGERADO C/ COMPRESSOR K 180 12X1/1 GN
CÓDIGO / CODE / CÓDIGO / CODE		2134.010	2134.012
<b>Preço / Prix / Precio / Price</b>	€	<b>6.887,00</b>	<b>7.516,00</b>
Dimensões Ext. / Dimensions / Dimensiones / Dimensions	mm	525x 825x 1355	525x 770x 1605
Dimensões Int. / Dimensions / Dimensiones / Dimensions	mm	330x 540x 1000	330x 540x 1000
Potência/ Puissance/ Potencia/ Power	kW	0,24	0,24
Tensão/ Tension/ Tensión/ Tension	V	230	230
Capacidade Tabuleiros / Capacité Plateaux / Capacidad Bandejas / Tray capacity	nr	12x1/1 GN	12x1/1 GN
Temperatura/ Température/ Temperatura/ Temperature	°c	+2/+8	+2/+8
Espaço Entre Guias/ Espace entre les guides/	mm	80	80
Peso Bruto/ Poids Brut/	Kg	70	95



2134.014



2134.018



2134.020

MODELO / MODÈLE / MODELO / MODEL		MISTO CF150 4+6 GN1/1	MISTO CF240 8+8GN1/1	MISTO CF360 12+12GN1/1
CÓDIGO / CODE / CÓDIGO / CODE		2134.014	2134.018	2134.020
<b>Preço / Prix / Precio / Price</b>	€	<b>7.915,00</b>	<b>10.444,00</b>	<b>11.733,00</b>
Dimensões Ext. / Dimensions / Dimensiones / Dimensions	mm	525x 810x 1285	920x 805x 1190	920x 825x 1355
Dimensões Int. / Dimensions / Dimensiones / Dimensions	mm	-	-	-
Compartimento Refrigeração	mm	330x 540x 348	330x 540x 668	330x 540x 1000
Compartimento Aquecido	mm	330x 540x 508	330x 540x 668	330x 540x 1000
Classe de isolamento/ Classe d'isolation		IP 44	IP 44	IP 44
Tensão/ Tension/ Tensión/ Tension	V	230	230	230
Capacidade Tabuleiros / Capacité Plateaux / Capacidad Bandejas / Tray capacity	nr	4+6GN 1/1	8+8GN 1/1	12x1/1 GN
Refrigerador/ Réfrigérateur/ Refrigerador/ Cooling	w	180	180	180
Aquecimento/ Chauffage/ Calefacción/ Heating	W	1000	1000	1000
Temperatura/ Température/ Temperatura/ Temperature	°c	+2/+8 +30/+90	+2/+8 +30/+90	+2/+8 +30/+90
Espaço Entre Guias/ Espace entre les guides/	mm	80	80	80
Peso Bruto/ Poids Brut/	Kg	70	115	135



2134.022



2134.024

MODELO / MODÈLE / MODELO / MODEL		NEUTRO S180 12GN1/1	NEUTRO DUPLO SS360R 12+12GN1/1
CÓDIGO / CODE / CÓDIGO / CODE		2134.022	2134.024
<b>Preço / Prix / Precio / Price</b>	€	<b>3.300,00</b>	<b>6.384,00</b>
Dimensões Ext. / Dimensions / Dimensiones / Dimensions	mm	525x 700x 1330	920x 700x 1330
Dimensões Int. / Dimensions / Dimensiones / Dimensions	mm	330x 540x 1000	330x 330x 540x 1000
Classe de isolamento/ Classe d'isolation		IP 44	IP 44
Capacidade Tabuleiros / Capacité Plateaux / Capacidad Bandejas / Tray capacity	nr	12x 1/1GN	GN 12+12 1/1 GN
Temperatura/ Température/ Temperatura/ Temperature	°c	ambiente	ambiente
Espaço Entre Guias/ Espace entre les guides/	mm	80	80
Peso Bruto/ Poids Brut/	Kg	50	100



Corpo em aço inoxidável  
Termostato digital  
Indicador de aquecimento interior  
Sistema de humedificação  
Gaveta removível e de fácil limpeza  
Fechadura magnética  
Rodas bloqueáveis para melhor estabilização  
Isolamento de poliuretano 40kg/m<sup>3</sup>



Corps en acier inoxydable  
thermostat numérique  
indicateur de chauffage intérieur  
système d'humidification  
Tiroir amovible et facile à nettoyer  
serrure magnétique  
Roues verrouillables pour une meilleure stabilisation  
Isolation polyuréthane 40kg/m<sup>3</sup>



Cuerpo de acero inoxidable  
termostato digital  
indicador de calefacción interior  
sistema de humedificación  
Cajón extraíble y fácil de limpiar  
cerradura magnética  
Ruedas bloqueables para una mejor estabilización.  
Aislamiento de poliuretano 40kg/m<sup>3</sup>



Stainless steel body  
digital thermostat  
indoor heating indicator  
humidification system  
Removable, easy-to-clean drawer  
magnetic lock  
Lockable wheels for better stabilization  
Polyurethane insulation 40kg/m<sup>3</sup>



50° - 90°

MODELO / MODÈLE / MODELO / MODEL CÓDIGO / CODE / CÓDIGO / CODE	CARRO MANTEDOR UDCM	
		5900.200
<b>Preço / Prix / Precio / Price</b>	€	<b>3.180,00</b>
Dimensões / Dimensions / Dimensiones (LPA)	mm	810x930x1660
Capacidade / Capacité / Capacidad / Capacity	nr	15xGN2/1 - 30xGN1/1
Peso / Poids / Peso / Weight	kg	166
Potência / Puissance / Potencia / Power	kW	2
Tensão / Tension / Tensión / Tension	V	230



50° - 90°

MODELO / MODÈLE / MODELO / MODEL CÓDIGO / CODE / CÓDIGO / CODE	CARRO MANTEDOR UDCM1	
		5900.205
<b>Preço / Prix / Precio / Price</b>	€	<b>3.362,00</b>
Dimensões / Dimensions / Dimensiones (LPA)	mm	625x845x1890
Capacidade / Capacité / Capacidad / Capacity	nr	18xGN2/1 - 36xGN1/1
Peso / Poids / Peso / Weight	kg	141
Potência / Puissance / Potencia / Power	kW	2
Tensão / Tension / Tensión / Tension	V	230



50° - 90°

MODELO / MODÈLE / MODELO / MODEL CÓDIGO / CODE / CÓDIGO / CODE	CARRO MANTEDOR UDCM2	
		5900.210
<b>Preço / Prix / Precio / Price</b>	€	<b>6.254,00</b>
Dimensões / Dimensions / Dimensiones (LPA)	mm	1310x845x1890
Capacidade / Capacité / Capacidad / Capacity	nr	36xGN2/1 - 72xGN1/1
Peso / Poids / Peso / Weight	kg	253
Potência / Puissance / Potencia / Power	kW	2
Tensão / Tension / Tensión / Tension	V	230





UDI

**CARROS MANTEDORES AQUECIDOS BANQUETES**  
**CHARRIOTS MAINTENEURS CHAUFFÉS BANQUETS**  
**CARROS MANTENEDORES CALENTADOS BANQUETS**  
**HEATED TROLLEY MAINTAINERS FOR BANQUETS**



Corpo em aço inoxidável  
 Termostato digital  
 Indicador de aquecimento interior  
 Sistema de humedificação  
 Gaveta removível e de fácil limpeza  
 Fechadura magnética  
 Rodas bloqueáveis para melhor estabilização  
 Isolamento de poliuretano 40kg/m<sup>3</sup>



Corps en acier inoxydable  
 thermostat numérique  
 indicateur de chauffage intérieur  
 système d'humidification  
 Tiroir amovible et facile à nettoyer  
 serrure magnétique  
 Roues verrouillables pour une meilleure stabilisation  
 Isolation polyuréthane 40kg/m<sup>3</sup>



Cuerpo de acero inoxidable  
 termostato digital  
 indicador de calefacción interior  
 sistema de humidificación  
 Cajón extraíble y fácil de limpiar  
 cerradura magnética  
 Ruedas bloqueables para una mejor estabilización.  
 Aislamiento de poliuretano 40kg/m<sup>3</sup>



Stainless steel body  
 digital thermostat  
 indoor heating indicator  
 humidification system  
 Removable, easy-to-clean drawer  
 magnetic lock  
 Lockable wheels for better stabilization  
 Polyurethane insulation 40kg/m<sup>3</sup>



0° - 90°

MODELO / MODÈLE / MODELO / MODEL	UDCTA1	
CÓDIGO / CODE / CÓDIGO / CODE	5200.030	
<b>Preço / Prix / Precio / Price</b>	€	<b>3.796,00</b>
Dimensões / Dimensions / Dimensiones (LPA)	mm	717x888x1803
Dimensões Internas /Dim. Int. /Dim. Internas /Internal Dim.		510x680x1340
Capacidade / Capacité / Capacidad / Capacity	nr	11xGN2/1 - 22xGN1/1
Espaço entre Guias /Espace guides /Espacio guias /Guides space	mm	70
Peso / Poids / Peso / Weight	kg	111
Potência / Puissance / Potencia / Power	kW	1,7
Tensão / Tension / Tensión / Tension	V	230



0° - 90°

MODELO / MODÈLE / MODELO / MODEL	UDCTA2	
CÓDIGO / CODE / CÓDIGO / CODE	5200.032	
<b>Preço / Prix / Precio / Price</b>	€	<b>6.308,00</b>
Dimensões / Dimensions / Dimensiones (LPA)	mm	1352x888x1803
Dimensões Internas /Dim. Int. /Dim. Internas /Internal Dim.		510x680x1340 x2
Capacidade / Capacité / Capacidad / Capacity	nr	2x11xGN2/1 - 2x22xGN1/1
Espaço entre Guias /Espace guides /Espacio guias /Guides space	mm	70
Peso / Poids / Peso / Weight	kg	200
Potência / Puissance / Potencia / Power	kW	3,4
Tensão / Tension / Tensión / Tension	V	230



Assador vertical elétrico, com duas portas pivotantes e duas pegas, espetos rotativos, modelo com três "espadas" centrais e duas "espadas" laterais, painel de comandos de fácil acesso.



Asador vertical eléctrico, com dos puertas pivotantes y dos asas, espetos rotativos, modelo con tres "espadas" centrales y dos "espadas" laterales, panel de control de fácil acceso.



Rôtissoire verticale électrique avec deux portes battantes et deux poignées, brochettes rotatives, modèle avec trois "épées" centrales et deux "épées" latérales, panneau de contrôle facilement accessible.



Electric vertical grill, with two pivoting doors and two handles, rotating spikes, model with three central "swords" and two lateral "swords", easily accessible control panel.

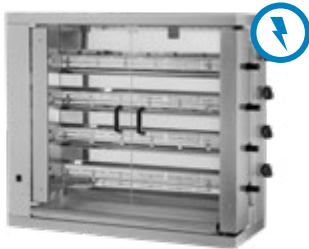

MODELO / MODÈLE / MODELO / MODEL	UAFV24E	
CÓDIGO / CODE / CÓDIGO / CODE	2012.520	
<b>Preço / Prix / Precio / Price</b>	<b>€</b>	<b>3.359,00</b>
Dimensões / Dimensions / Dimensiones	mm	1098x480x1000
Espetos / Brochettes / Pinchos / Spits	nr	4
Frangos / Poulets / Pollos / Chickens	nr	24
Peso Líquido-Bruto / Poids Net-Brut / Peso Neto-Bruto / Net-Gross Weight	Kg	95-
Potência / Puissance / Potencia / Power	kW	13,2
Tensão / Tension / Tensión / Tension	V	400



MODELO / MODÈLE / MODELO / MODEL	UDAF210E	UDAF315E	UDAF420E	
CÓDIGO / CODE / CÓDIGO / CODE	2012.702E	2012.704E	2012.706E	
<b>Preço / Prix / Precio / Price</b>	<b>€</b>	<b>2.253,00</b>	<b>2.807,00</b>	<b>3.321,00</b>
Dimensões / Dimensions / Dimensiones	mm	1100x 450x 610	1100x 450x 780	1100x 450x 970
Espetos / Brochettes / Pinchos / Spits	nr	2	3	4
Frangos / Poulets / Pollos / Chickens	nr	10-12	15-18	20-24
Peso Líquido-Bruto / Poids Net-Brut / Peso Neto-Bruto / Net-Gross Weight	Kg	-48	-61	-74
Potência / Puissance / Potencia / Power	kW	8,4	12,6	16,8
Tensão / Tension / Tensión / Tension	V	380	380	380



MODELO / MODÈLE / MODELO / MODEL	UDAF630E	UDAF840E	
CÓDIGO / CODE / CÓDIGO / CODE	2012.708E	2012.712E	
<b>Preço / Prix / Precio / Price</b>	<b>€</b>	<b>4.335,00</b>	<b>5.668,00</b>
Dimensões / Dimensions / Dimensiones	mm	1100x 450x 1730	1100x 450x 1960
Espetos / Brochettes / Pinchos / Spits	nr	6	8
Frangos / Poulets / Pollos / Chickens	nr	30-36	40-48
Peso Líquido-Bruto / Poids Net-Brut / Peso Neto-Bruto / Net-Gross Weight	Kg	-113	-137
Potência / Puissance / Potencia / Power	kW	25,2	33,6
Tensão / Tension / Tensión / Tension	V	380	380



MODELO / MODÈLE / MODELO / MODEL	UDAFDOUBLE11	UDAFDOUBLE15	
CÓDIGO / CODE / CÓDIGO / CODE	2012.714E	2012.716E	
<b>Preço / Prix / Precio / Price</b>	<b>€</b>	<b>5.971,00</b>	<b>7.491,00</b>
Dimensões / Dimensions / Dimensiones	mm	1100x 450x 1730	1100x 450x 1890
Espetos / Brochettes / Pinchos / Spits	nr	11	15
Frangos / Poulets / Pollos / Chickens	nr	55-66	75-90
Peso Líquido-Bruto / Poids Net-Brut / Peso Neto-Bruto / Net-Gross Weight	Kg	-134	-157
Potência / Puissance / Potencia / Power	kW	25,2	33,6
Tensão / Tension / Tensión / Tension	V	380	380

 elétrico  
 électrique  
 eléctrico  
 electric

 gás  
 gaz  
 gas  
 gas



UDI

## ASSADORES DE FRANGO VERTICAIS

RÔTISSOIRES À POULETS

ASADORES DE POLLOS

CHICKEN ROASTING SPITS



MODELO / MODÈLE / MODELO / MODEL CÓDIGO / CODE / CÓDIGO / CODE	ESTUFA RE/2 2230.043
<b>Preço / Prix / Precio / Price</b>	€ <b>3.468,00</b>
Dimensões / Dimensions / Dimensiones	mm 850x700x1050
Peso Bruto / Poids Brut / Peso Bruto / Gross Weight	kg 80
Potência / Puissance / Potencia / Power	kW 1,5
Tensão / Tension / Tensión / Tension	V -



2230.040



2230.041

MODELO / MODÈLE / MODELO / MODEL CÓDIGO / CODE / CÓDIGO / CODE	RBG/8 2230.040	RBG/12 2230.041
<b>Preço / Prix / Precio / Price</b>	€ <b>2.807,00</b>	<b>3.098,00</b>
Dimensões / Dimensions / Dimensiones	mm 800x350x955	1100x450x780
Peso Líquido-Bruto / Poids Net-Brut / Peso Neto-Bruto / Net-Gross Weight	Kg 40-	-61
Potência / Puissance / Potencia / Power	kcal/h -	18.000
Tensão / Tension / Tensión / Tension	V -	230



Preparado para gas butano/propano ou gás natural, espetos rotativos, modelo com três "espadas" centrais e duas "espadas" laterais.



Préparé pour le gaz butane, propane ou naturel. Deux portes pivotantes et deux poignées.



Preparado para gas butano, propano ou natural. Dos puertas pivotantes y dos asas.



Prepared for butane, propane or natural gas. Two pivoting doors and two handles.



MODELO / MODÈLE / MODELO / MODEL CÓDIGO / CODE / CÓDIGO / CODE	UDAF210G 2012.702G	UDAF315G 2012.704G	UDAF420G 2012.706G
<b>Preço / Prix / Precio / Price</b>	€ <b>2.253,00</b>	<b>2.807,00</b>	<b>3.321,00</b>
Dimensões / Dimensions / Dimensiones	mm 1100x450x610	1100x450x780	1100x450x970
Peso Líquido-Bruto / Poids Net-Brut / Peso Neto-Bruto / Net-Gross Weight	Kg -48	-61	-74
Gás butano - propano / Butane-propane gas	kg/h 1,108-0,98	1,66 -1,47	2,277-1,96
Gás natural / Gaz naturel / Gas natural / Natural gas	m3/h 1,07	1,605	2,15
Potência / Puissance / Potencia / Power	kcal/h 12.000	18.000	24.000
Espetos / Brochettes / Pinchos / Spits	nr 2	3	4
Frangos / Poulets / Pollos / Chickens	nr 10-12	15-18	20-24
Tensão / Tension / Tensión / Tension	V 230	230	230



MODELO / MODÈLE / MODELO / MODEL CÓDIGO / CODE / CÓDIGO / CODE	UDAF630G 2012.708G	UDAF735G 2012.710G	UDAF840G 2012.712G
<b>Preço / Prix / Precio / Price</b>	€ <b>4.335,00</b>	<b>6.227,00</b>	<b>5.668,00</b>
Dimensões / Dimensions / Dimensiones	mm 1100x450x1730	1100x450x1960	1100x450x1960
Peso Líquido-Bruto / Poids Net-Brut / Peso Neto-Bruto / Net-Gross Weight	Kg -113	-141	-137
Gás butano - propano / Butane-propane gas	kg/h 3,326-2,94	-	4,435-3,92
Gás natural / Gaz naturel / Gas natural / Natural gas	m3/h 3,23	-	4,31
Potência / Puissance / Potencia / Power	kcal/h 36.000	46.000	48.000
Espetos / Brochettes / Pinchos / Spits	nr 6	7	8
Frangos / Poulets / Pollos / Chickens	nr 30-36	-	40-48
Tensão / Tension / Tensión / Tension	V 230	230	230



MODELO / MODÈLE / MODELO / MODEL CÓDIGO / CODE / CÓDIGO / CODE	UDAFDOBLE 11 ESPETOS 2012.714G	UDAFDOBLE 15 ESPETOS 2012.716G
<b>Preço / Prix / Precio / Price</b>	€ <b>5.971,00</b>	<b>7.491,00</b>
Dimensões / Dimensions / Dimensiones	mm 1100x450x1730	1100x450x1890
Peso Líquido-Bruto / Poids Net-Brut / Peso Neto-Bruto / Net-Gross Weight	Kg -134	-157
Gás butano - propano / Butane-propane gas	kg/h 3,326-2,94	4,435-3,92
Gás natural / Gaz naturel / Gas natural / Natural gas	m3/h 3,23	4,31
Potência / Puissance / Potencia / Power	kcal/h 36.000	48.000
Espetos / Brochettes / Pinchos / Spits	nr 11	15
Frangos / Poulets / Pollos / Chickens	nr 55-66	75-90
Tensão / Tension / Tensión / Tension	V 230	230

elétrico  
électrique  
eléctrico  
electricgás  
gaz  
gas  
gasconfirmar disponibilidade  
confirmer la disponibilité  
confirmar la disponibilidad  
confirm the availability



Assador de frangos vertical, equipado com resistências elétricas de grande potência protegidas com cristal vitrocerâmico para facilitar a limpeza.



Asador de pollos vertical, equipado con resistencias eléctricas de gran potencia protegidas con cristal vitrocerámico para facilitar la limpieza.



Rôtissoire verticale pour grill, équipée de résistances électriques de forte puissance protégées par un verre en vitroceramique facilitant le nettoyage.



Vertical broiler rotisserie, equipped with high power electrical resistors protected with glass ceramic glass for easy cleaning.



Queimador vitrocerâmico  
Brûleur vitroceramique  
Queimador de vitrocerámica  
Vitroceramic burner



2012.738E

MODELO / MODÈLE / MODELO / MODEL CÓDIGO / CODE / CÓDIGO / CODE		UDAFV210E 2 ESPETOS 2012.734E	UDAFV315E 3 ESPETOS 2012.736E	UDAFV420E 4 ESPETOS 2012.738E
<b>Preço / Prix / Precio / Price</b>	€	<b>2.962,00</b>	<b>3.683,00</b>	<b>4.372,00</b>
Dimensões / Dimensions / Dimensiones	mm	1100x 450x 610	1100x 450x 780	1100x 450x 970
Espetos / Brochettes / Pinchos / Spits	nr	2	3	4
Frangos / Poulets / Pollos / Chickens	nr	10-12	15-18	20-24
Peso Líquido-Bruto / Poids Net-Brut / Peso Neto-Bruto / Net-Gross Weight	Kg	-58	-74	-94
Potência / Puissance / Potencia / Power	kW	8,4	12,6	16,8
Tensão / Tension / Tensión / Tension	V	380	380	380



2012.740E

MODELO / MODÈLE / MODELO / MODEL CÓDIGO / CODE / CÓDIGO / CODE		UDAFV630E 6 ESPETOS 2012.740E	UDAFV840E 8 ESPETOS 2012.742E	UDAFV11E 11 ESPETOS 2012.744E	UDAFV15E 15 ESPETOS 2012.746E
<b>Preço / Prix / Precio / Price</b>	€	<b>5.670,00</b>	<b>6.878,00</b>	<b>7.887,00</b>	<b>9.383,00</b>
Dimensões / Dimensions / Dimensiones	mm	1100x 450x 1730	1100x 450x 1960	1100x 450x 1730	1100x 450x 1960
Espetos / Brochettes / Pinchos / Spits	nr	6	8	11	15
Frangos / Poulets / Pollos / Chickens	nr	30-36	40-48	55-66	75-90
Peso Líquido-Bruto / Poids Net-Brut / Peso Neto-Bruto / Net-Gross Weight	Kg	-137	-166	-163	-191
Potência / Puissance / Potencia / Power	kW	25,2	33,6	25,2	33,6
Tensão / Tension / Tensión / Tension	V	380	380	380	380



UDI

**CHURRASQUEIRAS ROTATIVAS E FIXAS**  
RÔTISSOIRES ROTATIVES ET FIXES  
BARBACOAS ROTATIVAS Y FIJAS  
ROTATIVE AND FIXED BARBECUE GRILLS



As paredes laterais exteriores e interiores são isoladas com lâ de rocha, o fundo é em tijolo refractário de alta densidade.



Les parois latérales extérieures et intérieurs sont isolées avec laine de roche, le fond est à brique réfractaire de haute densité.



Las paredes laterales exteriores e interiores están aisladas con lana de roca, el fondo con ladrillo refractario es de alta densidad.



The lateral outside and inside walls are insulated with rock wool, the bottom is of high density refractory brick.





**GRELHAS FIXAS  
GRILLES FIXES  
REJILLAS FIJAS  
FIXED GRIDS**



MODELO / MODÈLE / MODELO / MODEL	1250X 600X900
CÓDIGO / CODE / CÓDIGO / CODE	2058.259
Preço / Prix / Precio / Price	€ 3.720,00
Dimensões / Dimensions / Dimensiones	mm 1250X 600X900
Grelha fixa / Grille fixe / Rejilla fija / Fixed grid*	nr 5

 Temperatura de trabalho: 500 ° C  
 Carne p/hora : 20 Kg  
 Forno a carvão em aço inox corpo com isolamento, gaveta recolhe cinzas.

 Température de travail: 500 ° C  
 Viande par heure: 20 Kg  
 Corps isolé du four à charbon en acier inoxydable, le tiroir recueille les cendres.

 Temperatura de trabajo: 500 ° C  
 Carne por hora: 20 Kg  
 Horno de carbón de acero inoxidable con cuerpo aislado, cajón recoge cenizas.

 Working temperature: 500 ° C  
 Meat per hour: 20 Kg  
 Stainless steel charcoal oven insulated body, drawer collects ashes.



MODELO / MODÈLE / MODELO / MODEL CÓDIGO / CODE / CÓDIGO / CODE	UDFC 40K VERMELHO 5200.072	
<b>Preço / Prix / Precio / Price</b>	€	<b>7.707,00</b>
Dimensões / Dimensions / Dimensiones	mm	740x745x650/1210
Grelha / Grille / Rejilla / Grid	mm	560x524
Peso Bruto / Poids Brut / Peso Bruto / Gross Weight	kg	205

MODELO / MODÈLE / MODELO / MODEL CÓDIGO / CODE / CÓDIGO / CODE	UDFC 50K PRETO 5200.074	
<b>Preço / Prix / Precio / Price</b>	€	<b>10.396,00</b>
Dimensões / Dimensions / Dimensiones	mm	920x850x650/1320
Grelha / Grille / Rejilla / Grid	mm	740x650
Peso Bruto / Poids Brut / Peso Bruto / Gross Weight	kg	275



MODELO / MODÈLE / MODELO / MODEL CÓDIGO / CODE / CÓDIGO / CODE	SUPORTE P/ UDFC 40K 5200.072S		SUPORTE P/ UDFC 50K 5200.074S	
<b>Preço / Prix / Precio / Price</b>	€	<b>946,00</b>		<b>1.284,00</b>
Dimensões / Dimensions / Dimensiones	mm (LPA)	730x730x790		920x845x815
Peso / Poids / Peso / Weight	kg	40		56





UDI

**LAVA MÃOS / BALDES DE DETRITOS**

LAVE-MAINS / BOÎTES À POUBELLES

LAVAMANOS / CUBOS DE BASURA

HAND WASHBASINS / GARBAGE BUCKETS



Lava mãos de pedestal, mural e eletrónico em aço inoxidável.  
Balões de Detritos construção em aço inoxidável; Tampa amovível. Opção com ou sem pedal.



Lave-mains avec piédestal, mural et électronique en acier inoxydable.  
Boîtes à Poubelles construction en acier inoxydable avec couvercle amovible. Option avec ou sans pédale.



Lavamanos con pedestal, mural y electrónico de acero inoxidable.  
Cubos de Basura Construcción de acero inoxidable; Tapa amovible. Opción con o sin pedal.



Stainless steel washbasins with pedestal, wall mounted and electronic.  
Garbage Buckets manufactured in stainless steel; Removable cover. With or without pedal option.

Joelho 1 água  
Genou 1 eau  
Rodilla 1 agua  
Knee 1 water



MODELO / MODÈLE / MODELO / MODEL	JOELHO 1 ÁGUA
CÓDIGO / CODE / CÓDIGO / CODE	2236.752
Preço / Prix / Precio / Price	€ 321,00
Dimensões / Dimensions / Dimensiones	mm 400x300x250



MODELO / MODÈLE / MODELO / MODEL	PEDAL 2 ÁGUAS
CÓDIGO / CODE / CÓDIGO / CODE	2236.750
Preço / Prix / Precio / Price	€ 411,00
Dimensões / Dimensions / Dimensiones	mm 400x400x850



MODELO / MODÈLE / MODELO / MODEL	1 PULSANTE 2 ÁGUAS	2 PULSANTES PEDAL 2 ÁGUAS
CÓDIGO / CODE / CÓDIGO / CODE	2236.302	2236.304
Preço / Prix / Precio / Price	€ 414,00	€ 456,00
Dimensões / Dimensions / Dimensiones	mm 450x450x850	450x450x850



MODELO / MODÈLE / MODELO / MODEL	ELETRÓNICO 2 ÁGUAS
CÓDIGO / CODE / CÓDIGO / CODE	2236.306
Preço / Prix / Precio / Price	€ 742,00
Dimensões / Dimensions / Dimensiones	mm 450x450x850



MODELO / MODÈLE / MODELO / MODEL	SEM PEDAL	COM PEDAL
CÓDIGO / CODE / CÓDIGO / CODE	2236.762	2236.760
Preço / Prix / Precio / Price	€ 261,00	€ 325,00
Dimensões / Dimensions / Dimensiones	mm 395x580	395x580
Capacidade / Capacité / Capacidad / Capacity	lt 50	50
Com pedal / Avec pedale / Con pedal / With pedal	mm -	√
Com rodas / Avec roues / Con ruedas / With wheels	mm √	√
Peso Bruto / Poids Brut / Peso Bruto / Gross Weight	Kg 6	6

Sem pedal / Sans pédal / Sin pedal / Without pedal

Com pedal / Avec pédale / Con pedal / With pedal



confirmar disponibilidade  
confirmer la disponibilité  
confirmar la disponibilidad  
confirm the availability

 Bancadas com tulha e gaveta em aço inox  
 Aisi 304

 Meuble de café en acier inoxydable  
 Aisi 304

 Muebles cafetero en acero inox  
 aisi 304

 Aisi 304 stainless steel coffee  
 units

2236.421



2236.423

MODELO / MODÈLE / MODELO / MODEL CÓDIGO / CODE / CÓDIGO / CODE		BANCADA COM TULHA 2236.421	BANCADA COM TULHA 2236.423
<b>Preço / Prix / Precio / Price</b>	€	<b>502,00</b>	<b>797,00</b>
Dimensões / Dimensions / Dimensiones	mm	700x600x850	700x600x850



2236.421SX



2236.424

MODELO / MODÈLE / MODELO / MODEL CÓDIGO / CODE / CÓDIGO / CODE		BANCADA COM TULHA 2236.421SX	BANCADA COM TULHA 2236.424
<b>Preço / Prix / Precio / Price</b>	€	<b>502,00</b>	<b>797,00</b>
Dimensões / Dimensions / Dimensiones	mm	700x600x850	700x600x850



2236.422



2236.425

MODELO / MODÈLE / MODELO / MODEL CÓDIGO / CODE / CÓDIGO / CODE		BANCADA COM TULHA E GAVETA 2236.422	BANCADA COM TULHA E GAVETA 2236.425
<b>Preço / Prix / Precio / Price</b>	€	<b>707,00</b>	<b>1.003,00</b>
Dimensões / Dimensions / Dimensiones	mm	1000x600x850	1000x600x850
Gaveta / Tiroir / Cajon / Drawer	mm	410x420x115	410x420x115



2236.422SX



2236.426

MODELO / MODÈLE / MODELO / MODEL CÓDIGO / CODE / CÓDIGO / CODE		BANCADA COM TULHA E GAVETA 2236.422SX	BANCADA COM TULHA E GAVETA 2236.426
<b>Preço / Prix / Precio / Price</b>	€	<b>707,00</b>	<b>1.003,00</b>
Dimensões / Dimensions / Dimensiones	mm	1000x600x850	1000x600x850
Gaveta / Tiroir / Cajon / Drawer	mm	410x420x115	410x420x115

**MESAS DE TRABALHO COM ESTUFA MONTADO**

TABLES DE TRAVAIL AVEC ÉTUVE MONTÉ

MESAS DE TRABAJO CON CALIENTAMIENTO MONTADO

HEATED WORKING TABLES MOUNTED

 Mesas de trabalho com estufa, portas deslizantes  
 e prateleira intermédia. Temperatura regulável  
 até 90°C.

 Tables de travail avec étuve, portes  
 coulissantes et étagère intermédiaire  
 Température réglable jusqu'à 90°C

 Mesas de trabajo con calefacción, puertas  
 deslizantes y estante intermedia. Temperatura  
 regulable hasta 90°C

 Heated working tables with intermediate shelf  
 and sliding door. Temperature regulated up  
 to 90°C

600mm



700mm



MODELO / MODÈLE / MODELO / MODEL CÓDIGO / CODE / CÓDIGO / CODE		2236.686	2236.688	2236.690
<b>Preço / Prix / Precio / Price</b>	€	<b>1.672,00</b>	<b>2.315,00</b>	<b>3.086,00</b>
Dimensões / Dimensions / Dimensiones	mm	1000x600x850	1400x600x850	2000x600x850
Peso / Poids / Peso / Weight	kg	45	65	70
Potência / Puissance / Potencia / Power	kW	1,5	1,5	1,5
Tensão / Tension / Tensión / Tension	V	230	230	230

MODELO / MODÈLE / MODELO / MODEL CÓDIGO / CODE / CÓDIGO / CODE		2236.694	2236.696	2236.698
<b>Preço / Prix / Precio / Price</b>	€	<b>1.929,00</b>	<b>2.572,00</b>	<b>3.601,00</b>
Dimensões / Dimensions / Dimensiones	mm	1000x700x850	1400x700x850	2000x700x850
Peso / Poids / Peso / Weight	kg	50	70	90
Potência / Puissance / Potencia / Power	kW	1,5	1,5	1,5
Tensão / Tension / Tensión / Tension	V	230	230	230

Outras dimensões sob consulta | Autres dimensions sur demande | Otras dimensiones bajo pedido | Other dimensions on request

Para os aços montados, o transporte é por conta e risco do cliente a partir da sede na Maia | Pour l'acier assemblé, le transport est à la charge du client du siège à Maia | Para los aceros montados, el transporte es por cuenta y riesgo del cliente a partir de la sede en Maia | For assembled steel, transportation is at the customer's own risk from the headquarters in Maia





UDI

## MESAS LAVA PRATOS ENTRADA SAÍDA MONTADO

TABLES POUR LAVE-VAISSELLE MONTÉ

MESAS ENTRADA Y SALIDA LAVAVAJILLAS MONTADO

DISHWASHER TABLES MOUNTED



CÓDIGO / CODE / CÓDIGO / CODE	2236.906	2236.908
Preço / Prix / Precio / Price	€ 1.106,00	1.286,00
Dimensões / Dimensions / Dimensiones	mm 1200x735x850	1500x735x850



CÓDIGO / CODE / CÓDIGO / CODE	2236.906DX	2236.908DX
Preço / Prix / Precio / Price	€ 1.106,00	1.286,00
Dimensões / Dimensions / Dimensiones	mm 1200x735x850	1500x735x850



CÓDIGO / CODE / CÓDIGO / CODE	2236.904
Preço / Prix / Precio / Price	€ 566,00
Dimensões / Dimensions / Dimensiones	mm 650x735x850



CÓDIGO / CODE / CÓDIGO / CODE	2236.904SX
Preço / Prix / Precio / Price	€ 566,00
Dimensões / Dimensions / Dimensiones	mm 650x735x850



V-1583
2025.028
311,00
700x600x850

## ARMÁRIOS MURAI - MONTADO

ARMOIRES MURALES - MONTÉ

ARMARIOS MURALES - MONTADO

WALL CUPBOARDS - MOUNTED



CÓDIGO / CODE / CÓDIGO / CODE	2236.602	2236.604	2236.606
Preço / Prix / Precio / Price	€ 527,00	791,00	1.054,00
Dimensões / Dimensions / Dimensiones	mm 1000x400x600	1500x400x600	2000x400x600



3 Prateleiras  
3 Étagères  
3 Estanterías  
3 Shelves

## ARMÁRIOS VERTICAIS - MONTADO

ARMOIRES VERTICALES - MONTÉ

ARMARIOS VERTICALES - MONTADO

STAND CUPBOARDS - MOUNTED

CÓDIGO / CODE / CÓDIGO / CODE	2236.610	2236.612	2236.614	2236.616
Preço / Prix / Precio / Price	€ 1.286,00	1.800,00	1672,00	2.340,00
Dimensões / Dimensions / Dimensiones	mm 1000x400x1800	1400x400x1800	1000x600x1800	1400x600x1800

Outras dimensões sob consulta | Autres dimensions sur demande | Otras dimensiones bajo pedido | Other dimensions on request

Para os aços montados, o transporte é por conta e risco do cliente a partir da sede na Maia | Pour l'acier assemblé, le transport est à la charge du client du siège à Maia | Para los aceros montados, el transporte es por cuenta y riesgo del cliente a partir de la sede en Maia | For assembled steel, transportation is at the customer's own risk from the headquarters in Maia

 Mesas de trabalho feitas em aço inoxidável; Estrutura sólida; Com uma ou duas prateleiras.

 Tables de travail en acier inoxydable ; Structure solide ; Avec une ou deux étagères.

 Mesas de trabajo en acero inoxidable; Estructura sólida; Con una o dos estantes.

 Working tables in stainless steel; Solid structure; With one or two shelves.



600mm

MODELO / MODÈLE / MODELO / MODEL	CÓDIGO / CODE / CÓDIGO / CODE	2236.620	2236.622	2236.624
<b>Preço / Prix / Precio / Price</b>	€	<b>386,00</b>	<b>579,00</b>	<b>772,00</b>
Dimensões / Dimensions / Dimensiones	mm	1000x600x850	1500x600x850	2000x600x850



700mm

MODELO / MODÈLE / MODELO / MODEL	CÓDIGO / CODE / CÓDIGO / CODE	2236.630	2236.632	2236.634
<b>Preço / Prix / Precio / Price</b>	€	<b>437,00</b>	<b>656,00</b>	<b>874,00</b>
Dimensões / Dimensions / Dimensiones	mm	1000x700x850	1500x700x850	2000x700x850



600mm

MODELO / MODÈLE / MODELO / MODEL	CÓDIGO / CODE / CÓDIGO / CODE	2236.636	2236.638	2236.640
<b>Preço / Prix / Precio / Price</b>	€	<b>437,00</b>	<b>656,00</b>	<b>874,00</b>
Dimensões / Dimensions / Dimensiones	mm	1000x600x850	1500x600x850	2000x600x850



700mm

MODELO / MODÈLE / MODELO / MODEL	CÓDIGO / CODE / CÓDIGO / CODE	2236.642	2236.644	2236.646
<b>Preço / Prix / Precio / Price</b>	€	<b>476,00</b>	<b>714,00</b>	<b>952,00</b>
Dimensões / Dimensions / Dimensiones	mm	1000x700x850	1500x700x850	2000x700x850

**MESAS DE TRABALHO COM PORTAS MONTADO**

 TABLES DE TRAVAIL AVEC PORTES MONTÉ  
 MESAS DE TRABAJO CON PUERTAS MONTADO  
 WORKING TABLE WITH DOORES MOUNTED

600mm



MODELO / MODÈLE / MODELO / MODEL	CÓDIGO / CODE / CÓDIGO / CODE	2 PRATELEIRAS / 2 ETAGÈRES / 2 ESTANTES / 2 SHELFs
<b>Preço / Prix / Precio / Price</b>	€	<b>939,00</b> <b>1.252,00</b> <b>1.723,00</b>
Dimensões / Dimensions / Dimensiones	mm	1000x600x850    1400x600x850    2000x600x850

700mm



MODELO / MODÈLE / MODELO / MODEL	CÓDIGO / CODE / CÓDIGO / CODE	2 PRATELEIRAS / 2 ETAGÈRES / 2 ESTANTES / 2 SHELFs
<b>Preço / Prix / Precio / Price</b>	€	<b>990,00</b> <b>1.319,00</b> <b>1.813,00</b>
Dimensões / Dimensions / Dimensiones	mm	1000x700x850    1400x700x850    2000x700x850

Outras dimensões sob consulta | Autres dimensions sur demande | Otras dimensiones bajo pedido | Other dimensions on request

Para os aços montados, o transporte é por conta e risco do cliente a partir da sede na Maia | Pour l'acier assemblé, le transport est à la charge du client du siège à Maia | Para los aceros montados, el transporte es por cuenta y riesgo del cliente a partir de la sede en Maia | For assembled steel, transportation is at the customer's own risk from the headquarters in Maia



UDI



**MESAS DE TRABALHO DESMONTADO**  
TABLES DE TRAVAIL DÉMONTÉ  
MESAS DE TRABAJO DESMONTADO  
UNMOUNTED WORKING TABLE



Mesas de trabalho feitas em aço inoxidável; Estrutura sólida; Com uma ou duas prateleiras.



Tables de travail en acier inoxydable ; Structure solide ; Avec une ou deux étagères.



Mesas de trabajo en acero inoxidable; Estructura sólida; Con una o dos estantes.



Working tables in stainless steel; Solid structure; With one or two shelves.



600mm

MODELO / MODÈLE / MODELO / MODEL		2236.620D	2236.622D	2236.624D
CÓDIGO / CODE / CÓDIGO / CODE				
Preço / Prix / Precio / Price	€	476,00	669,00	862,00
Dimensões / Dimensions / Dimensiones	mm	1000x600x850	1500x600x850	2000x600x850

DESMONTADA | DÉMONTÉ | DESMONTADA | UNMOUNTED



700mm

MODELO / MODÈLE / MODELO / MODEL		2236.630D	2236.632D	2236.634D
CÓDIGO / CODE / CÓDIGO / CODE				
Preço / Prix / Precio / Price	€	527,00	746,00	964,00
Dimensões / Dimensions / Dimensiones	mm	1000x700x850	1500x700x850	2000x700x850

DESMONTADA | DÉMONTÉ | DESMONTADA | UNMOUNTED

### PRATELEIRAS MURAL / ESTANTERIAS MODULARES DESMONTADO

ÉTAGÈRES MURALE / RAIONAGES MODULAIRES DÉMONTÉ  
ESTANTERÍAS MURAL / ESTANTERÍAS MODULARES DESMONTADO  
WALL SHELVES / MODULAR SHELVING UNMOUNTED

Prateleira  
Étagère  
Estantería  
Shelf

300mm



CÓDIGO / CODE / CÓDIGO / CODE		2236.704	2236.706	2236.708
Preço / Prix / Precio / Price	€	103,00	154,00	206,00
Dimensões / Dimensions / Dimensiones	mm	1000x300	1500x300	2000x300

400mm



CÓDIGO / CODE / CÓDIGO / CODE		2236.710	2236.712	2236.714
Preço / Prix / Precio / Price	€	141,00	211,00	283,00
Dimensões / Dimensions / Dimensiones	mm	1000x400	1500x400	2000x400

Estanteria modular perfurada  
Raionage modulaire perforé  
Estantería modular perforada  
Perforated modular shelving



MODELO / MODÈLE / MODELO / MODEL		PERFORADA / PERFORÉ PERFORADA / PERFORATED	
CÓDIGO / CODE / CÓDIGO / CODE		2236.720	2236.722
Preço / Prix / Precio / Price	€	566,00	792,00
Dimensões / Dimensions / Dimensiones	mm	1000x400x1800	1400x400x1800
Profundidade / Profondeur / Profundidad / Depth	mm	75	85

Estanteria modular lisa  
Raionage modulaire plan  
Estantería modular plana  
Flat modular shelving

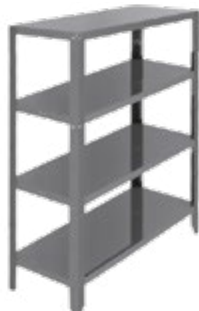

MODELO / MODÈLE / MODELO / MODEL		LISA / PLAN PLANA / FLAT	
CÓDIGO / CODE / CÓDIGO / CODE		2236.728	2236.730
Preço / Prix / Precio / Price	€	514,00	720,00
Dimensões / Dimensions / Dimensiones	mm	1000x400x1800	1400x400x1800
Profundidade / Profondeur / Profundidad / Depth	mm	80	90

Outras dimensões sob consulta | Autres dimensions sur demande | Otras dimensiones bajo pedido | Other dimensions on request



- Carne / Viande / Carne / Meat
- Peixe / Poisson / Pescado / Fish
- Legumes / Légumes / Verduras / Vegetables



CÓDIGO / CODE / CÓDIGO / CODE	2236.658	2236.659
Preço / Prix / Precio / Price	€ 1.016,00	1.106,00
Dimensões / Dimensions / Dimensiones	mm 1400x600x850	1400x700x850

CÓDIGO / CODE / CÓDIGO / CODE	2236.658DX	2236.659DX
Preço / Prix / Precio / Price	€ 1.016,00	1.106,00
Dimensões / Dimensions / Dimensiones	mm 1400x600x850	1400x700x850



600mm

MODELO / MODÈLE / MODELO / MODEL	1 CUBAS / 1 CUVES / 1 CUBAS / SINGLE BOWL		
CÓDIGO / CODE / CÓDIGO / CODE	2236.650	2236.652	2236.654
Preço / Prix / Precio / Price	€ 707,00	784,00	862,00
Dimensões / Dimensions / Dimensiones	mm 1000x600x850	1200x600x850	1400x600x850

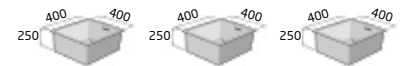

600mm

MODELO / MODÈLE / MODELO / MODEL	1 CUBAS / 1 CUVES / 1 CUBAS / SINGLE BOWL		
CÓDIGO / CODE / CÓDIGO / CODE	2236.650DX	2236.652DX	2236.654DX
Preço / Prix / Precio / Price	€ 707,00	784,00	862,00
Dimensões / Dimensions / Dimensiones	mm 1000x600x850	1200x600x850	1400x600x850



700mm

MODELO / MODÈLE / MODELO / MODEL	1 CUBAS / 1 CUVES / 1 CUBAS / SINGLE BOWL		
CÓDIGO / CODE / CÓDIGO / CODE	2236.660	2236.662	2236.664
Preço / Prix / Precio / Price	€ 810,00	898,00	977,00
Dimensões / Dimensions / Dimensiones	mm 1000x700x850	1200x700x850	1400x700x850

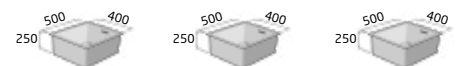

700mm

MODELO / MODÈLE / MODELO / MODEL	1 CUBAS / 1 CUVES / 1 CUBAS / SINGLE BOWL		
CÓDIGO / CODE / CÓDIGO / CODE	2236.660DX	2236.662DX	2236.664DX
Preço / Prix / Precio / Price	€ 810,00	898,00	977,00
Dimensões / Dimensions / Dimensiones	mm 1000x700x850	1200x700x850	1400x700x850

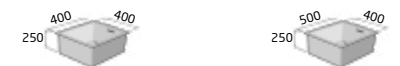

MODELO / MODÈLE / MODELO / MODEL	2 CUBAS / 2 CUVES / 2 CUBAS / DOUBLE BOWL	
CÓDIGO / CODE / CÓDIGO / CODE	2236.656	2236.666
Preço / Prix / Precio / Price	€ 1.183,00	1.358,00
Dimensões / Dimensions / Dimensiones	mm 1400x600x850	1400x700x850

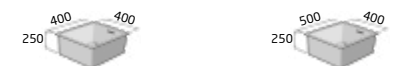

MODELO / MODÈLE / MODELO / MODEL	2 CUBAS / 2 CUVES / 2 CUBAS / DOUBLE BOWL	
CÓDIGO / CODE / CÓDIGO / CODE	2236.656DX	2236.666DX
Preço / Prix / Precio / Price	€ 1.183,00	1.358,00
Dimensões / Dimensions / Dimensiones	mm 1400x600x850	1400x700x850

Outras dimensões sob consulta | Autres dimensions sur demande | Otras dimensiones bajo pedido | Other dimensions on request

Para os aços montados, o transporte é por conta e risco do cliente a partir da sede na Maia | Pour l'acier assemblé, le transport est à la charge du client du siège à Maia | Para los aceros montados, el transporte es por cuenta y riesgo del cliente a partir de la sede en Maia | For assembled steel, transportation is at the customer's own risk from the headquarters in Maia



UDI

**BANCADAS DE LAVAGEM - DESMONTADO**

PLONGES - DÉMONTÉ

FREGADEROS - DESMONTADO

SKINK UNITS - UNMOUNTED



600mm

MODELO / MODÈLE / MODELO / MODEL	1 CUBAS / 1 CUVES / 1 CUBAS / SINGLE BOWL		
CÓDIGO / CODE / CÓDIGO / CODE	2236.650D	2236.652D	2236.654DM
Preço / Prix / Precio / Price	€ 707,00	784,00	862,00
Dimensões / Dimensions / Dimensiones	mm 1000x600x850	1200x600x850	1400x600x850

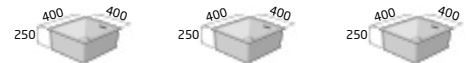

600mm

MODELO / MODÈLE / MODELO / MODEL	1 CUBAS / 1 CUVES / 1 CUBAS / SINGLE BOWL		
CÓDIGO / CODE / CÓDIGO / CODE	2236.650DDX	2236.652DDX	2236.654DDM
Preço / Prix / Precio / Price	€ 707,00	784,00	862,00
Dimensões / Dimensions / Dimensiones	mm 1000x600x850	1200x600x850	1400x600x850

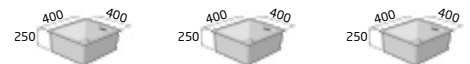

700mm

MODELO / MODÈLE / MODELO / MODEL	1 CUBAS / 1 CUVES / 1 CUBAS / SINGLE BOWL		
CÓDIGO / CODE / CÓDIGO / CODE	2236.660D	2236.662D	2236.664D
Preço / Prix / Precio / Price	€ 810,00	898,00	977,00
Dimensões / Dimensions / Dimensiones	mm 1000x700x850	1200x700x850	1400x700x850

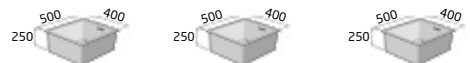

700mm

MODELO / MODÈLE / MODELO / MODEL	1 CUBAS / 1 CUVES / 1 CUBAS / SINGLE BOWL		
CÓDIGO / CODE / CÓDIGO / CODE	2236.660DDX	2236.662DDX	2236.664DDX
Preço / Prix / Precio / Price	€ 810,00	898,00	977,00
Dimensões / Dimensions / Dimensiones	mm 1000x700x850	1200x700x850	1400x700x850

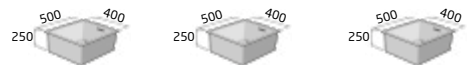

MODELO / MODÈLE / MODELO / MODEL	2 CUBAS / 2 CUVES / 2 CUBAS / DOUBLE BOWL	
CÓDIGO / CODE / CÓDIGO / CODE	2236.656D	2236.666D
Preço / Prix / Precio / Price	€ 1.183,00	1.358,00
Dimensões / Dimensions / Dimensiones	mm 1400x600x850	1400x700x850



MODELO / MODÈLE / MODELO / MODEL	2 CUBAS / 2 CUVES / 2 CUBAS / DOUBLE BOWL	
CÓDIGO / CODE / CÓDIGO / CODE	2236.656DDX	2236.666DDX
Preço / Prix / Precio / Price	€ 1.183,00	1.358,00
Dimensões / Dimensions / Dimensiones	mm 1400x600x850	1400x700x850

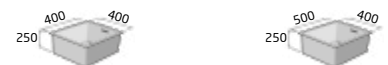

Outras dimensões sob consulta | Autres dimensions sur demande | Otras dimensiones bajo pedido | Other dimensions on request



Cepo de corte desmontável  
Table de découpe démontable  
Tajo de desmontable troceo  
Demountable carving table

CÓDIGO / CODE / CÓDIGO / CODE	2236.700	2236.702	2236.716	2236.718
Preço / Prix / Precio / Price	€ 669,00	746,00	977,00	1.337,00
Dimensões / Dimensions / Dimensiones	mm 600x700x 850	700x700x 850	1000x700x 850	1500x700x 850

**CEPOS DE CORTE DESMONTADO**

TABLES DE DÉCOUPE DÉMONTÉ

TAJOS DE TROCEO DESMONTADO

CARVING TABLES UNMOUNTED



CÓDIGO / CODE / CÓDIGO / CODE	2236.700D	2236.702D	2236.716D	2236.718D
Preço / Prix / Precio / Price	€ 759,00	836,00	1.067,00	1.440,00
Dimensões / Dimensions / Dimensiones	mm 600x700x 850	700x700x 850	1000x700x 850	1500x700x 850

Outras dimensões sob consulta | Autres dimensions sur demande | Otras dimensiones bajo pedido | Other dimensions on request

Para os aços montados, o transporte é por conta e risco do cliente a partir da sede na Maia | Pour l'acier assemblé, le transport est à la charge du client du siège à Maia | Para los aceros montados, el transporte es por cuenta y riesgo del cliente a partir de la sede en Maia | For assembled steel, transportation is at the customer's own risk from the headquarters in Maia



UDI

**APANHA FUMOS MONTADO**  
**HOTTES À EXTRACTION MONTÉ**  
**CAMPANAS DE EXTRACCIÓN MONTADO**  
**HOOD EXTRACTOR MOUNTED**



Apanha fumos centrais e murais em inox.  
 Apanha fumos centrais e murais compensados em inox.  
 Filtros para apanha fumos em rede e em inox (não incluídos).



Hottes à extraction centrales et murales en inox.  
 Hottes à extraction centrales et murales compensées en inox.  
 Filtres pour hottes à extraction en tamis et inox (non inclus).



Campanas de extracción centrales y de pared en acero inoxidable.  
 Campanas de extracción centrales y de pared compensadas en acero inoxidable.  
 Filtros para campanas de extracción en red y acero inoxidable (no incluidos).



Central and wall mounted hood extractors in stainless.  
 Compensated central and wall mounted hood extractors in stainless.  
 Filters for hood extractors in net and stainless (not included).



MODELO / MODÈLE / MODELO / MODEL		MURAL / MURAL / PARED WALL MOUNTED		
CÓDIGO / CODE / CÓDIGO / CODE		2236.774	2236.776	2236.778
<b>Preço / Prix / Precio / Price</b>	€	<b>964,00</b>	<b>1.286,00</b>	<b>1.607,00</b>
Dimensões / Dimensions / Dimensiones	mm	1500x1000x600	2000x1000x600	2500x1000x600
Capacidade Filtros / Capacité Filtres / Capacidad Filtros / Filter Capacity	nr	2	3	4



MODELO / MODÈLE / MODELO / MODEL		MURAL COMPENSADO / MURAL COMPENSÉE PARED COMPENSADA / COMPENSATED WALL MOUNTED		
CÓDIGO / CODE / CÓDIGO / CODE		2236.781	2236.782	2236.784
<b>Preço / Prix / Precio / Price</b>	€	<b>1.157,00</b>	<b>1.543,00</b>	<b>1.929,00</b>
Dimensões / Dimensions / Dimensiones	mm	1500x1000x600	2000x1000x600	2500x1000x600
Capacidade Filtros / Capacité Filtres / Capacidad Filtros / Filter Capacity	nr	2	3	4



MODELO / MODÈLE / MODELO / MODEL		CENTRAL	
CÓDIGO / CODE / CÓDIGO / CODE		2236.766	2236.768
<b>Preço / Prix / Precio / Price</b>	€	<b>2.932,00</b>	<b>3.279,00</b>
Dimensões / Dimensions / Dimensiones	mm	2000x2200x600	2500x2200x600
Capacidade Filtros / Capacité Filtres / Capacidad Filtros / Filter Capacity	nr	6	8



MODELO / MODÈLE / MODELO / MODEL		CENTRAL COMPENSADO / CENTRAL COMPENSÉE CENTRAL COMPENSADA / CENTRAL COMPENSATED	
CÓDIGO / CODE / CÓDIGO / CODE		2236.770	2236.773
<b>Preço / Prix / Precio / Price</b>	€	<b>3.518,00</b>	<b>3.935,00</b>
Dimensões / Dimensions / Dimensiones	mm	2000x2200x600	2500x2200x600
Capacidade Filtros / Capacité Filtres / Capacidad Filtros / Filter Capacity	nr	6	8

REDE  
TAMIS  
RED  
NET

INOX  
INOX  
ACERO INOXIDABLE  
STAINLESS STEEL





MODELO / MODÈLE / MODELO / MODEL		REDE / TAMIS RED / NET	INOX / INOX ACERO INOXIDABLE STAINLESS STEEL
CÓDIGO / CODE / CÓDIGO / CODE		2236.786A	2236.788A
<b>Preço / Prix / Precio / Price</b>	€	<b>46,00</b>	<b>46,00</b>
Dimensões / Dimensions / Dimensiones	mm	500x500x-	500x500x-
Capacidade Filtros / Capacité Filtres / Capacidad Filtros / Filter Capacity	nr	-	-

Outras dimensões sob consulta | Autres dimensions sur demande | Otras dimensiones bajo pedido | Other dimensions on request

Para os aços montados, o transporte é por conta e risco do cliente a partir da sede na Maia | Pour l'acier assemblé, le transport est à la charge du client du siège à Maia | Para los aceros montados, el transporte es por cuenta y riesgo del cliente a partir de la sede en Maia | For assembled steel, transportation is at the customer's own risk from the headquarters in Maia

 Elemento Banho-Maria com estufa: Estufa ventilada; Portas deslizantes; Controlador digital regulável para banho-maria e controlador mecânico para estufa. Elemento Refrigerado com vitrina refrigerada: Construção em aço inox AISI 304. Controlador digital. Pés reguláveis; 3 níveis de prateleiras; Evaporador na parte superior da vitrina. Elementos Neutros: Com prateleira intermédia e pés reguláveis. Elemento controle caixa: Com gaveta, proteção lateral, plano deslizante e pés reguláveis. Elemento de Distribuição: Distribuidor de pão, talheres, copos e tabuleiros; Pés em inox reguláveis em altura

 Élément Bain-Marie avec étuve : Étuve ventilée; Portes coulissantes; Contrôleur digital pour Bain Marie e réglable pour étuve. Élément Réfrigéré avec vitrine réfrigérée: Construction en acier inox AISI 304; Contrôleur digital; Pieds réglables; 3 niveaux d'étagères; Évaporateur dans la partie supérieure de la vitrine. Éléments Neutres : Avec étagère; Pieds réglables. Élément contrôle caisse : Avec tiroir, protection latérale, plan glissant et pieds réglables. Élément de Distribution : Distributeur de pain, couverts, coupes et plateaux; Pieds en inox réglables en hauteur.

 Elemento Baño María con estufa: Ventilado; Puertas deslizantes; Controlador digital ajustable para el baño maría y regulador mecánico para calentar. Elemento Refrigerado con vitrina refrigerada: Construido en acero inoxidable AISI 304; Controlador digital; Pies ajustables; 3 niveles de estantes; Evaporador en la parte superior de la vitrina. Elementos Neutros: Con estante intermedia y pies regulables. Elemento controle caja: Con cajón, protección lateral, plan deslizante y pies regulables. Elemento de Distribución: Distribuidor de pan, cubiertos, vasos y bandejas; Pies regulables en altura en acero inoxidable.

 Bain-Marie with warm understorage unit: Ventilated; Sliding doors; Direct heating system. Digital control for bain-marie and mechanical control for warm under storage. Refrigerated Display Unit with refrigerated showcase: Made of AISI 304 Stainless steel; Digital control. Shelves with 3 levels; Refrigerated unit. Neutral Units: With intermediate shelf and adjustable height bullet feet. Box control unit: With drawer, side protection, sliding plan and adjustable feet. Dispenser Unit: Dispenser of bread, cutlery, cups and trays; Adjustable height bullet feet.

Elemento de distribuição  
Élément de distribution  
Elemento de distribución  
Dispenser unit

Elemento refrigerado com vitrina refrigerada  
Élément réfrigéré avec vitrine réfrigérée  
Elemento refrigerado com vitrina refrigerada  
Refrigerated display unit with refrigerated showcase

Elemento banho-maria com estufa  
Élément bain-marie avec étuve  
Elemento baño maría con estufa  
Bain-marie with warm understorage unit

Elemento neutro  
Élément neutre  
Elemento neutro  
Neutral unit

Elemento neutro ângulo externo 90°  
Élément neutre angle externe 90°  
Elemento neutro ângulo externo 90°  
90° external angle neutral unit

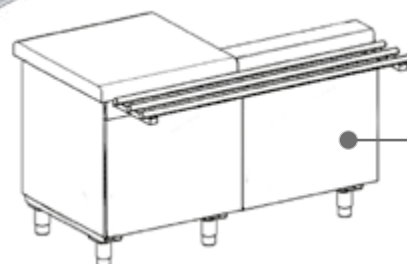

Elemento controle caixa  
Élément controle boîte  
Elemento control caja  
Box control unit





UDI

SELF-SERVICE - RESTAURAÇÃO

SELF-SERVICE - RESTAURATION

SELF-SERVICE - RESTAURACIÓN

SELF-SERVICE - HOTEL INDUSTRY



Decoração em Inox. Inclui prateleira de vidro curvo, vidro frontal aparabafos, e plano deslizante. Containers e separadores GN não incluídos



Décoration en inox. Comprend étagère de verre bombé, verre frontale pare-haleine et rampes à plateaux. Containers et séparateurs GN non inclus.



Decoración en acero inoxidable. Incluye estante de vidrio curvo, vidrio delantero protege aliento y plan deslizante. Containers y separadores GN no incluidos



Decoration in Stainless. Curved glass shelf, front glass sneeze screen and sliding plan included. Containers and GN dividers not included

Elemento de distribuição  
Élément de distribution  
Elemento de distribución  
Dispenser unit



Distribuidor de copos não incluído  
Distributeur à tasses non inclus  
Distribuidor de vasos non incluído  
Glass dispenser not included



Cores Disponíveis - Sob Consulta  
Couleurs disponibles - Sur Consulte  
Colores disponibles - Sob Pedido  
Available Colours - Under Request

MODELO / MODÈLE / MODELO / MODEL	ELEMENTO DISTRIBUIÇÃO	
CÓDIGO / CODE / CÓDIGO / CODE		2238.010
Preço / Prix / Precio / Price	€	2.055,00
Dimensões / Dimensions / Dimensiones	mm	631x700x1576

Elemento banho-maria com estufa  
Élément bain-marie avec étuve  
Elemento baño maría con estufa  
Bain-marie with warm  
Understorage unit



Plano deslizante incluído  
Plan glissant inclus  
Plan deslizante incluído  
Sliding plan included

MODELO / MODÈLE / MODELO / MODEL	ELEMENTO BANHO MARIA COM ESTUFA	
CÓDIGO / CODE / CÓDIGO / CODE		2238.002
Preço / Prix / Precio / Price	€	4.641,00
Dimensões / Dimensions / Dimensiones	mm	1450x750x905
Containers / Containers / Envases / Containers	nr	4x1/1

Elemento refrigerado com vitrina refrigerada  
Élément réfrigéré avec vitrine réfrigère  
Refrigerated display unit  
With refrigerated showcase



Plano deslizante incluído  
Plan glissant inclus  
Plan deslizante incluído  
Sliding plan included

MODELO / MODÈLE / MODELO / MODEL	ELEMENTO REFRIGERADO COM VITRINA REFRIGERADA	
CÓDIGO / CODE / CÓDIGO / CODE		2238.004
Preço / Prix / Precio / Price	€	9.685,00
Dimensões / Dimensions / Dimensiones	mm	1450x750x1755

Elemento neutro  
Élément neutre  
Elemento neutro  
Neutral unit



Elemento controle caixa  
Élément controle boîte  
Elemento control caja  
Box control unit



MODELO / MODÈLE / MODELO / MODEL	ELEMENTO NEUTRO	ELEMENTO CONTROLE CAIXA	
CÓDIGO / CODE / CÓDIGO / CODE	2238.006	2238.008	
Preço / Prix / Precio / Price	€	1.620,00	2.181,00
Dimensões / Dimensions / Dimensiones	mm	1450x750x905	1450x750/150x905

Elemento neutro ângulo externo 90°  
Élément neutre angle externe 90°  
Elemento neutro ângulo externo 90°  
90° external angle neutral unit



MODELO / MODÈLE / MODELO / MODEL	ELEMENTO NEUTRO ÂNGULO EXTERNO 90°	
CÓDIGO / CODE / CÓDIGO / CODE		2238.014
Preço / Prix / Precio / Price	€	1.795,00
Dimensões / Dimensions / Dimensiones	mm	1535x750x850

Outras dimensões sob consulta | Autres dimensions sur demande | Otras dimensiones bajo pedido | Other dimensions on request

## Dimensões / Dimensions / Dimensiones

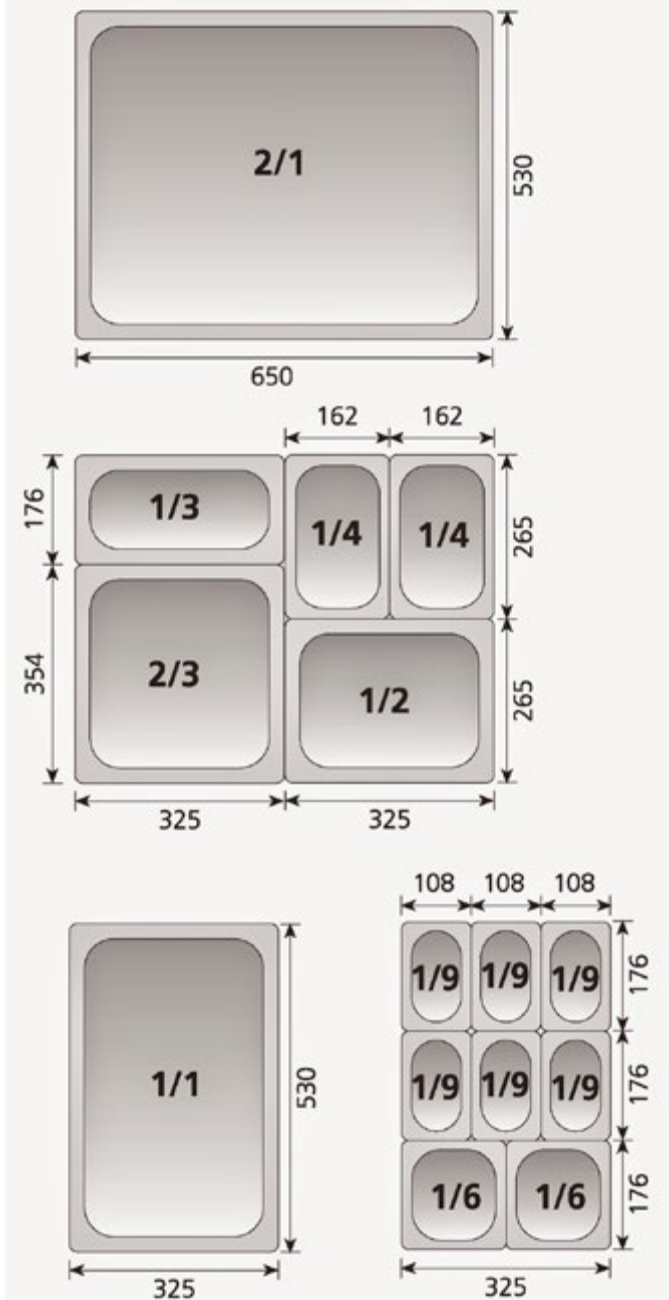

Mod.	Altura / Hauteur Altura / Height (mm)	Dim.	Vol.
GN 2/1	20	650x530	5
GN 2/1	40	650x530	10
GN 2/1	65	650x530	18,5
GN 2/1	100	650x530	28,5
GN 2/1	150	650x530	42,5
GN 1/1	20	325x530	2,5
GN 1/1	40	325x530	5
GN 1/1	65	325x530	9
GN 1/1	100	325x530	14
GN 1/1	150	325x530	21
GN 1/1	200	325x530	28
GN 2/3	20	325x354	1,5
GN 2/3	40	325x354	3
GN 2/3	65	325x354	5,5
GN 2/3	100	325x354	9
GN 2/3	150	325x354	13
GN 2/3	200	325x354	18
GN 1/2	20	325x265	1
GN 1/2	40	325x265	2
GN 1/2	65	325x265	4
GN 1/2	100	325x265	6,5
GN 1/2	150	325x265	9,5
GN 1/2	200	325x265	12,5
GN 1/3	65	325x176	2,5
GN 1/3	100	325x176	4
GN 1/3	150	325x176	5,7
GN 1/3	200	325x176	7,8
GN 1/4	65	265x162	1,8
GN 1/4	100	265x162	2,8
GN 1/4	150	265x162	4
GN 1/4	200	265x162	5,5
GN 1/6	65	176x162	1
GN 1/6	100	176x162	1,6
GN 1/6	150	176x162	2,4
GN 1/9	65	176x108	0,6
GN 1/9	100	176x108	1

Dimensões / Dimensions / Dimensiones (mm)

## TABULEIROS ESMALTADOS ANTI-ADERENTES / BAC ÉMAILLÉS ANTIADHÉRENTS / BANDEJAS ESMALTADAS ANTI-ADHERENTES / ENAMELLED ANTI-ADHERENT TRAYS



Cód.	Mod.	Altura / Hauteur Altura / Height (mm)	€
2050.152	1/1	20	29,00
2050.151	1/1	40	31,00
2050.150	1/1	65	33,00
2050.156	1/2	65	21,00

 confirmar disponibilidade  
 confirmer la disponibilité  
 confirmar la disponibilidad  
 confirm the availability



UDI

**TABULEIROS E TAMPAS EM AÇO INOX**

BACS ET COUVERCLES EN ACIER INOX

BANDEJAS Y TAPAS DE ACERO INOX

STAINLESS STEEL TRAYS AND COVERS



CONTAINERS

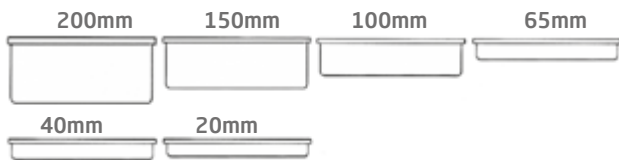

\*Com rebordo interior / Avec bord intérieur / Con el borde interior / With internal edge

Confirmar a disponibilidade de todos os códigos 5900  
 Confirmer la disponibilité de tous les codes 5900  
 Confirmar la disponibilidad de todos los códigos 5900  
 Confirm availability of all 5900 codes

Cód.	Mod.	Altura/Hauteur Altura/Height (mm)	€
2050.001	2/1	20	62,00
2050.002	2/1	40	69,00
5900.798	2/1	40	69,00
5900.800	2/1	65	77,00
2050.007	2/1	100	98,00
2050.008	2/1	150	133,00
5900.816	1/1	20	32,00
5900.818	1/1	40	37,00
5900.820	1/1	65	43,00
5900.822	1/1	100	46,00
2050.010	1/1	150	68,00
5900.824	1/1	150	63,00
5900.826	1/1	200	82,00
5900.828	2/3	20	26,00
2050.012	2/3	65	30,00
2050.013	2/3	100	36,00
2050.014	2/3	150	48,00
2050.014A	2/3	200	62,00
2050.014F	2/3	200	50,00
2050.015	1/2	20	17,00
2050.016	1/2	65	25,00
5900.840	1/2	65	25,00
2050.017	1/2	100	30,00
5900.860	1/2	100	30,00
2050.018	1/2	150	40,00
5900.862	1/2	150	38,00
5900.864	1/2	200	45,00
2050.018F	1/2	200	42,00
2050.018A	1/2	200	52,00
5900.874	1/3	65	18,00
5900.872	1/3	100	22,00
2050.020	1/3	100	22,00
2050.021	1/3	150	36,00
5900.870	1/3	150	36,00
2050.022	1/4	65	16,00
5900.886	1/4	65	16,00
2050.023	1/4	100	19,00
5900.888	1/4	100	19,00
5900.890	1/4	150	33,00
2050.024A	1/4	200	35,00
5900.896	1/6	100	15,00
5900.898	1/6	150	37,00

TAMPAS / COUVERCLES / TAPAS / COVERS



Cód.	Mod.	€
2050.044	1/1	26,00
5900.830	1/1	26,00
2050.045	2/3	21,00
2050.046	1/2	16,00
5900.850	1/2	17,00
2050.047	1/3	13,00
5900.880	1/3	13,00
2050.048	1/4	11,00
5900.900	1/4	11,00
5900.918	1/6	10,00
2050.049A	1/9	9,00



**CONTAINERS FURADOS / CONTAINERS PERFORÉS / CONTAINERS PERFORADOS / PERFORATED CONTAINERS**

Cód.	Modelo / Modèle / Modelo / Model	Altura / Hauteur Altura / Height (mm)	€
2050.028	1/1	20	36,00
5900.906	1/1	20	36,00
2050.029	1/1	40	37,00
2050.031	1/1	100	66,00
2050.032	1/1	150	86,00
2050.033	2/3	65	41,00
2050.034	2/3	100	49,00
2050.035	2/3	150	74,00
5900.922	2/3	150	74,00
2050.057	2/3	200	79,00
2050.036	2/1	20	67,00
2050.037	2/1	40	73,00
2050.038	2/1	65	119,00
2050.039	2/1	100	140,00
2050.040	2/1	150	188,00
2050.041	1/2	65	31,00
2050.042	1/2	100	40,00
5900.938	1/2	100	40,00
2050.043	1/2	150	53,00
5900.902	1/2	150	53,00



**confirmar disponibilidade**  
confirmer la disponibilité  
confirmar la disponibilidad  
confirm the availability

**FUNDOS FURADOS / FONDS PERFORÉS /  
FONDOS PERFORADOS / PERFORATED BASIS**

Cód.	Modelo / Modèle / Modelo / Model	€
2050.052	1/1	32,00
2050.053A	2/3	27,00
2050.053	1/2	18,00
2050.053B	1/3	14,00



**confirmar disponibilidade**  
confirmer la disponibilité  
confirmar la disponibilidad  
confirm the availability

**GRELHAS CROMADAS / GRILLES CHROMÉES /  
REJILLAS CROMADAS / CHROMED GRILLS**

Cód.	Modelo / Modèle / Modelo / Model	€
2050.334	2/3	19,00



**confirmar disponibilidade**  
confirmer la disponibilité  
confirmar la disponibilidad  
confirm the availability

**GRELHAS AÇO INOX / GRILLES ACIER INOX  
REJILLAS ACERO INOX / STAINLESS STEEL GRILLS**

Cód.	Modelo / Modèle / Modelo / Model	€
5900.910	1/1	46,00
5900.920	2/1	88,00
5900.930	60x40	60,00

**SEPARADORES / SÉPARATEURS / SEPARADORES / SEPARATORS**

Cód.	Modelo / Modèle / Modelo / Model	€	
2050.055	SEP 325	325	7,00
2050.054	SEP 530	530	8,00



UDI

**TABULEIROS EM POLICARBONATO E TAMPAS**

PLATEAUX EN POLYCARBONAT ET COUVERCLES

BANDEJAS EN POLICARBONATO Y TAPAS

POLYCARBONATE TRAYS AND COVERS



**CONTAINERS POLICARBONATO / CONTAINERS POLYCARBONAT / CONTAINERS POLICARBONATO / POLYCARBONATE CONTAINERS**



confirmar disponibilidade  
confirmer la disponibilité  
confirmar la disponibilidad  
confirm the availability



Cód.	Modelo / Modèle / Modelo / Model	Altura / Hauteur Height (mm)	€
2050.103	1/1	65	22,00
2050.102	1/1	100	29,00
5900.929	1/1	100	29,00
2050.101	1/1	150	35,00
5900.931	1/1	200	47,00
2050.109	1/2	65	12,00
2050.108	1/2	100	15,00
2050.107	1/2	150	21,00
5900.932	1/2	200	24,00
5900.940	1/3	65	11,00
2050.114	1/3	100	12,00
2050.113	1/3	150	15,00
2050.112	1/3	200	19,00
5900.950	1/4	65	9,00
5900.952	1/4	100	10,00
2050.118	1/4	150	13,00
5900.960	1/6	65	7,00
2050.124	1/6	100	8,00
2050.123	1/6	150	9,00
2050.128	1/9	100	6,00



confirmar disponibilidade  
confirmer la disponibilité  
confirmar la disponibilidad  
confirm the availability

**FUNDOS FURADOS / FONDS PERFORÉS  
FONDOS PERFORADOS / PERFORATED BASIS**

Cód.	Mod.	€
2050.105	1/1	12,00
2050.111	1/2	7,00
2050.117	1/3	4,00
2050.122	1/4	3,00



confirmar disponibilidade  
confirmer la disponibilité  
confirmar la disponibilidad  
confirm the availability

**TAMPAS / COUVERCLES / TAPAS / COVERS**

Cód.	Mod.	€
5900.970	1/1	17,00
5900.972	1/2	10,00
5900.974	1/3	7,00
2050.121	1/4	6,00
5900.976	1/4	6,00
5900.978	1/6	4,00
5900.980	1/9	4,00

TAMPAS / COUVERCLES / TAPAS / COVERS  
FUNDOS FURADOS / FONDS PERFORÉS / FONDOS PERFORADOS / PERFORATED BASIS



**PIZZARIA / PADARIA / PASTELARIA**  
PIZZERIA / BOULANGERIE / PÂTISSERIE  
PIZZERÍA / PANADERÍA / PASTELERÍA  
PIZZERIA / BAKERY / PASTRY

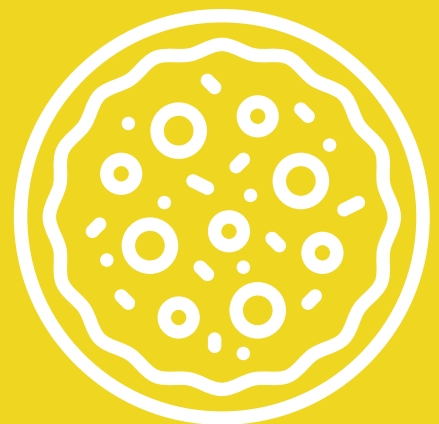



Amassadeiras espirais indicadas para trabalhar com diferentes tipos de massas, especialmente massas moles como pão, pizza e tortilha.  
 As ferramentas que estão em contacto com os alimentos (cuba, espiral e barra para romper a massa) são de aço inoxidável.  
 Micro interruptor na tampa da cuba.



Elevação manual  
 Levage manuel  
 Elevación manual  
 Manual lifting.



opcional  
 optionnel  
 opcional  
 optional



Machine pour réaliser différents types de pâtes, indiquée surtout pour les pâtes molles comme le pain, la pizza et la tortilla.  
 Pièces en contact avec les aliments (cuve, spirale et brise-pâte) en acier inox.  
 Micro-interrupteur sur couvercle cuve.

MODELO / MODELE / MODELO / MODEL	7/S	
CÓDIGO / CODE / CÓDIGO / CODE	2088.056A	
<b>Preço / Prix / Precio / Price</b>	€	<b>1.593,00</b>
Dimensões / Dimensions / Dimensiones	mm	280x560x570
Capacidade da Cuba / Capacité cuve / Capacidad cuba / Vat capacity	Lt	10
Capacidade de massa / Capacité pâte / Capacidad masa / Dough capacity	kg	7
Produção / Production / Producción / Production	h	21
Peso Líquido - Bruto / Poids Net-Brut / Peso Neto - Bruto / Net - Gross Weight	kg	39-50
Potência / Puissance / Potencia / Power	kW	0,37
Tensão / Tension / Tensión / Tension	V	230

MODELO / MODELE / MODELO / MODEL	12/S 2V		12/S 1V
CÓDIGO / CODE / CÓDIGO / CODE	2088.050		2088.051
<b>Preço / Prix / Precio / Price</b>	€	<b>1.989,00</b>	<b>1.842,00</b>
Dimensões / Dimensions / Dimensiones	mm	350x650x600	350x650x600
Capacidade da Cuba / Capacité cuve / Capacidad cuba / Vat capacity	Lt	16	16
Capacidade de massa / Capacité pâte / Capacidad masa / Dough capacity	kg	12	12
Produção / Production / Producción / Production	h	36	36
Peso Líquido - Bruto / Poids Net-Brut / Peso Neto - Bruto / Net - Gross Weight	kg	56-66	56-66
Potência / Puissance / Potencia / Power	kW	0,75	0,75
Tensão / Tension / Tensión / Tension	V	400	230

MODELO / MODELE / MODELO / MODEL	18/S 2V	
CÓDIGO / CODE / CÓDIGO / CODE	2088.056B	
<b>Preço / Prix / Precio / Price</b>	€	<b>2.090,00</b>
Dimensões / Dimensions / Dimensiones	mm	390x670x600
Capacidade da Cuba / Capacité cuve / Capacidad cuba / Vat capacity	Lt	22
Capacidade de massa / Capacité pâte / Capacidad masa / Dough capacity	kg	18
Produção / Production / Producción / Production	h	54
Peso Líquido - Bruto / Poids Net-Brut / Peso Neto - Bruto / Net - Gross Weight	kg	57-70
Potência / Puissance / Potencia / Power	kW	0,75
Tensão / Tension / Tensión / Tension	V	400

MODELO / MODELE / MODELO / MODEL	25/S 2V		25/S 1V
CÓDIGO / CODE / CÓDIGO / CODE	2088.052		2088.053
<b>Preço / Prix / Precio / Price</b>	€	<b>2.407,00</b>	<b>2.238,00</b>
Dimensões / Dimensions / Dimensiones	mm	430x780x710	430x780x710
Capacidade da Cuba / Capacité cuve / Capacidad cuba / Vat capacity	Lt	32	32
Capacidade de massa / Capacité pâte / Capacidad masa / Dough capacity	kg	25	25
Produção / Production / Producción / Production	h	75	75
Peso Líquido - Bruto / Poids Net-Brut / Peso Neto - Bruto / Net - Gross Weight	kg	96-107	96-107
Potência / Puissance / Potencia / Power	kW	1,5	1,5
Tensão / Tension / Tensión / Tension	V	400	230

MODELO / MODELE / MODELO / MODEL	38/S 2V		50/S 2V
CÓDIGO / CODE / CÓDIGO / CODE	2088.056		2088.058
<b>Preço / Prix / Precio / Price</b>	€	<b>2.611,00</b>	<b>4.422,00</b>
Dimensões / Dimensions / Dimensiones	mm	480x800x710	530x920x920
Capacidade da Cuba / Capacité cuve / Capacidad cuba / Vat capacity	Lt	42	62
Capacidade de massa / Capacité pâte / Capacidad masa / Dough capacity	kg	38	50
Produção / Production / Producción / Production	h	114	150
Peso Líquido - Bruto / Poids Net-Brut / Peso Neto - Bruto / Net - Gross Weight	kg	100-113	170-193
Potência / Puissance / Potencia / Power	kW	1,5	2,2
Tensão / Tension / Tensión / Tension	V	400	400

**SUPORTE C/ RODAS / SUPPORT AVEC ROUES**  
 SOPORTE CON RUEDAS / SUPPORT WITH WHEELS

Cód.	Ref.	Dimens. (mm)	€
2088.081	P/7 S/C, 12 S/C, 18 S/C	280x520x80	<b>151,00</b>
2088.082	P/ 25 S/C	330x600x80	<b>175,00</b>
2088.083	P/38 S/C	380x600x80	<b>175,00</b>



Cód.	Ref.	Dimens. (mm)	€
2088.083A	P/38 C	350x600x330	<b>152,00</b>

**CAVALETE / CHEVALET**  
 CABALLETE / STAND





UDI

**AMASSADEIRAS ESPIRAIS**  
PÉTRINS SPIRAIS  
AMASADORAS ESPIRALES  
SPIRAL KNEADERS



Máquina para realizar diferentes tipos de masas, se aconseja especialmente para masas suaves como pan, pizza y tortillas. Partes en contacto con los alimentos (cuba, espiral y barra para romper la masa) de acero inoxidable. Microinterruptor en la tapa de la cuba.



Machine that produces different types of dough, especially indicated for soft dough such as bread and pizza. Parts in contact with food (bowl, spiral and kneader rod) made of stainless steel. Safety micro switch on basin lid.

2V  
2 velocidades  
2 vitesses  
2 velocidades  
2 speeds

Elevação manual da cabeça  
Levage manuel  
Elevación manual de la cabeza  
Manual lifting cover

Cuba extraível  
Cuvette à extraire  
Cubeta extraíble  
Removable vat.



MODELO / MODELE / MODELO / MODEL	12C 1V	
CÓDIGO / CODE / CÓDIGO / CODE	2088.342	
<b>Preço / Prix / Precio / Price</b>	<b>€</b>	<b>2.430,00</b>
Dimensões / Dimensions / Dimensiones	mm	350x650x620/1060
Capacidade da Cuba /Capacité cuve /Capacidad cuba /Vat capacity	Lt	16
Capacidade de massa /Capacité pâte /Capacidad masa /Dough capacity	kg	12
Produção / Production / Producción / Production	h	36
Peso Líquido-Bruto /Poids Net-Brut /Peso Neto-Bruto /Net-Gross Weight	kg	63-73
Potência / Puissance / Potencia / Power	kW	0,75
Tensão / Tension / Tensión / Tension	V	230



MODELO / MODELE / MODELO / MODEL	18C 2V	
CÓDIGO / CODE / CÓDIGO / CODE	2088.342B	
<b>Preço / Prix / Precio / Price</b>	<b>€</b>	<b>2.628,00</b>
Dimensões / Dimensions / Dimensiones	mm	390x670x620/1090
Capacidade da Cuba /Capacité cuve /Capacidad cuba /Vat capacity	Lt	22
Capacidade de massa /Capacité pâte /Capacidad masa /Dough capacity	kg	18
Produção / Production / Producción / Production	h	54
Peso Líquido-Bruto /Poids Net-Brut /Peso Neto-Bruto /Net-Gross Weight	kg	107-118
Potência / Puissance / Potencia / Power	kW	0,75
Tensão / Tension / Tensión / Tension	V	400



MODELO / MODELE / MODELO / MODEL	25C 2V	
CÓDIGO / CODE / CÓDIGO / CODE	2088.343	
<b>Preço / Prix / Precio / Price</b>	<b>€</b>	<b>3.279,00</b>
Dimensões / Dimensions / Dimensiones	mm	430x780x730/1240
Capacidade da Cuba /Capacité cuve /Capacidad cuba /Vat capacity	Lt	32
Capacidade de massa /Capacité pâte /Capacidad masa /Dough capacity	kg	25
Produção / Production / Producción / Production	h	75
Peso Líquido-Bruto /Poids Net-Brut /Peso Neto-Bruto /Net-Gross Weight	kg	107-118
Potência / Puissance / Potencia / Power	kW	1,5
Tensão / Tension / Tensión / Tension	V	400



MODELO / MODELE / MODELO / MODEL	38C 2V	
CÓDIGO / CODE / CÓDIGO / CODE	2088.344	
<b>Preço / Prix / Precio / Price</b>	<b>€</b>	<b>3.505,00</b>
Dimensões / Dimensions / Dimensiones	mm	480x800x730/1340
Capacidade da Cuba /Capacité cuve /Capacidad cuba /Vat capacity	Lt	42
Capacidade de massa /Capacité pâte /Capacidad masa /Dough capacity	kg	38
Produção / Production / Producción / Production	h	114
Peso Líquido-Bruto /Poids Net-Brut /Peso Neto-Bruto /Net-Gross Weight	kg	114-127
Potência / Puissance / Potencia / Power	kW	1,5
Tensão / Tension / Tensión / Tension	V	400



Amassadeiras espirais de alta qualidade, especialmente indicadas para pastelarias, padarias e pizzerias.



Pétrins spirais de haute qualité, particulièrement adapté pour les pâtisseries, boulangeries et des pizzerias,



Amasadoras espirales de alta calidad, especialmente adecuadas para panaderías, pastelarias y pizzerias.



High quality spiral kneaders, especially suitable for pastries, bakeries and pizzerias.

2V - 2 velocidades / vitesses / velocidades / speeds  
2T - temporizador / temporisateur / temporizador / timer



MODELO / MODELE / MODELO / MODEL		UDP50 2V	UDP50 2V2T
CÓDIGO / CODE / CÓDIGO / CODE		2521.845	2521.855
<b>Preço / Prix / Precio / Price</b>	€	<b>3.862,00</b>	<b>4.974,00</b>
Dimensões / Dimensions / Dimensiones	mm	520x890x870	520x890x870
Capacidade da Cuba / Capacité cuve / Capacidad cuba / Vat capacity	Lt	64	64
Dimensão da Cuba / Dimension cuve / Dimension de la cuba / Vat dimension	Ømm	500x340	500x340
Capacidade de massa / Capacité pâte / Capacidad masa / Dough capacity	kg	45	45
Rot. espiral 1a velocidade / Rot. spirale 1ème vitesse / Rot. espiral 1a velocidad / 1st speed spiral rot.	rpm	88	88
Rot. espiral 2a velocidade / Rot. spirale 2ème vitesse / Rot. espiral 2a velocidad / 2nd speed spiral rot.	rpm	137	137
Peso Líquido-Bruto / Poids Net-Brut / Peso Neto-Bruto / Net-Gross Weight	kg	148-170	148-170
Potência / Puissance / Potencia / Power	kW	1,8-1,1	1,8-1,1
Tensão / Tension / Tensión / Tension	V	400	400



MODELO / MODELE / MODELO / MODEL		UDP70 2V	UDP70 2V2T
CÓDIGO / CODE / CÓDIGO / CODE		2521.860	2521.865
<b>Preço / Prix / Precio / Price</b>	€	<b>5.131,00</b>	<b>6.243,00</b>
Dimensões / Dimensions / Dimensiones	mm	570x950x920	570x950x920
Capacidade da Cuba / Capacité cuve / Capacidad cuba / Vat capacity	Lt	82	82
Dimensão da Cuba / Dimension cuve / Dimension de la cuba / Vat dimension	Ømm	550x340	550x340
Capacidade de massa / Capacité pâte / Capacidad masa / Dough capacity	kg	60	60
Rot. espiral 1a velocidade / Rot. spirale 1ème vitesse / Rot. espiral 1a velocidad / 1st speed spiral rot.	rpm	88	88
Rot. espiral 2a velocidade / Rot. spirale 2ème vitesse / Rot. espiral 2a velocidad / 2nd speed spiral rot.	rpm	137	137
Peso Líquido-Bruto / Poids Net-Brut / Peso Neto-Bruto / Net-Gross Weight	kg	158-180	158-180
Potência / Puissance / Potencia / Power	kW	1,8-1,1	1,8-1,1
Tensão / Tension / Tensión / Tension	V	400	400



UDI

**REFRIGERADORES DE ÁGUA - MISTURADOR - DOSEADOR**

RÉFRIGÉRATEUR D'EAU - MIXEUR - DOSEUR

REFRIGERADOR DE AGUA - MEZCLADOR - DOSIFICADOR

WATER REFRIGERATOR - MIXER - DOSER

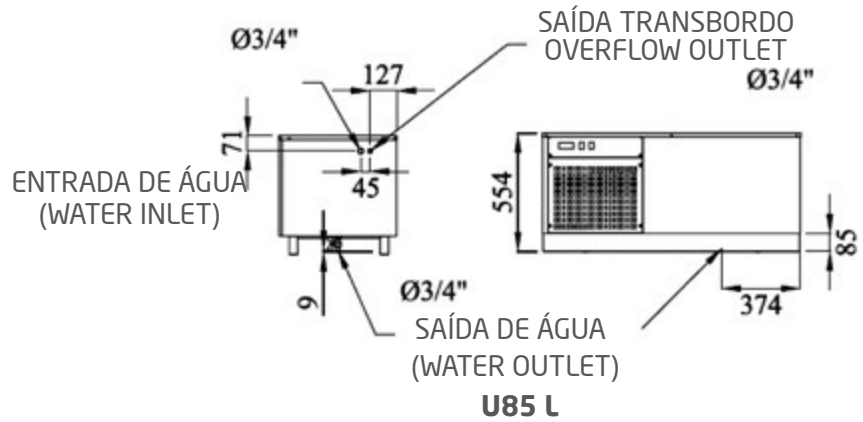

MODELO / MODELE / MODELO / MODEL	U85 L INOX	
CÓDIGO / CODE / CÓDIGO / CODE	2236.233	
<b>Preço / Prix / Precio / Price</b>	€	<b>2.210,00</b>
Dimensões / Dimensions / Dimensiones	mm	1225x560x554
Capacidade / Capacité / Capacidad / Capacity	Lt	80
Gás refrigerante / Gaz réfrigérant / Gas refrigerante / Refrig. gas		R290
Potência frigorífica / Puissance frigorifique / Potencia frigorífica / Refrigerant power	kW	0,945
Produção / Production / Producción / Production	h	27
Tempo Funcional / Fonctionnelle / Tiempo funcional / Functional time	rpm	80
Peso Líquido-Bruto / Poids Net-Brut / Peso Neto-Bruto / Net-Gross Weight	kg	-
Potência / Puissance / Potencia / Power	kW	0,862
Tensão / Tension / Tensión / Tension	V	230



MODELO / MODELE / MODELO / MODEL	U125 L INOX	U210 L INOX	
CÓDIGO / CODE / CÓDIGO / CODE	2236.230	2236.234	
<b>Preço / Prix / Precio / Price</b>	€	<b>2.799,00</b>	<b>4.018,00</b>
Dimensões / Dimensions / Dimensiones	mm	718x698x1069	1136x698x1119
Capacidade / Capacité / Capacidad / Capacity	Lt	120	200
Gás refrigerante / Gaz réfrigérant / Gas refrigerante / Refrig. gas		R290	R290
Potência frigorífica / Puissance frigorifique / Potencia frigorífica / Refrigerant power	kW	1,144	2 219
Produção / Production / Producción / Production	h	40	67
Tempo Funcional / Fonctionnelle / Tiempo funcional / Functional time	rpm	80	80
Peso Líquido-Bruto / Poids Net-Brut / Peso Neto-Bruto / Net-Gross Weight	kg	-	-
Potência / Puissance / Potencia / Power	kW	1 121	1 728
Tensão / Tension / Tensión / Tension	V	230	230



**SUPORTE DE PAREDE / SUPPORT DE MUR / SOPORTE DE PARED / WALL SUPPORT**

Cód.	Ref.	Dimens. (mm)	€
2236.237	P/ 125 L / 210 L	612x149x975	<b>234,00</b>
2236.239	P/85 L	612x149x475	<b>201,00</b>

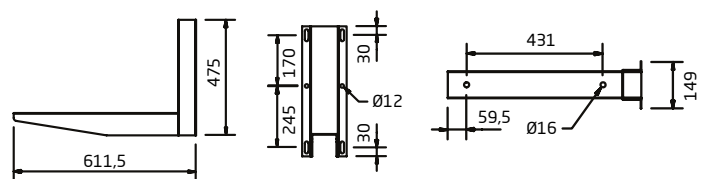

opcional  
optionnel  
opcional  
optional



O painel de Controlo multifunção permite tanto o modo manual tradicional como o modo automático programável, automatizando todas as operações cíclicas.  
Dois motores independentes para a espiral e para a cuba.  
As ferramentas que estão em contacto com os alimentos (cuba, espiral e barra de quebrar a massa) são de aço inoxidável AISI 304.  
A pedido pode-se fornecer a tampa de proteção ABS ao invés da grelha de proteção de aço inox.



Le panneau de commande multifonction permet à la fois le mode manuel traditionnel et le mode automatique programmable, automatiser toutes les opérations cycliques.  
Deux moteurs indépendants pour la spirale et la cuve.  
Pièces en contact avec les aliments (cuve, spirale et brise-pâte) en acier inox AISI 304.  
Sur demande nous pouvons fournir le couvercle de protection ABS au lieu de la grille de protection en acier inoxydable.



El panel de control multifunción permite tanto el modo manual tradicional como el modo automático programable, automatizar todas operaciones cíclicas.  
Dos motores independientes para la espiral y la cuba.  
Partes en contacto con los alimentos (cuba, espiral y barra para romper la masa) de acero inoxidable AISI 304.  
A solicitud es posible proveer una tapa de protección ABS en lugar de la rejilla de protección en acero inoxidable



The multifunction control panel allows both the traditional manual mode and the automatic programmable mode, automate all cyclic operations.  
Two independent motors for the spiral and the bowl.  
Parts in contact with food (bowl, spiral and kneader rod) made of AISI 304 stainless steel.  
On request can be supplied a ABS safety cover instead of the stainless steel guard.

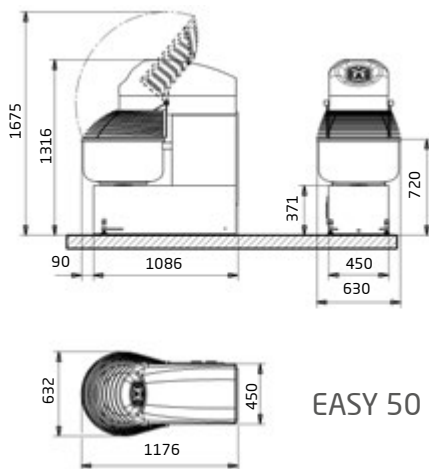

EASY 50

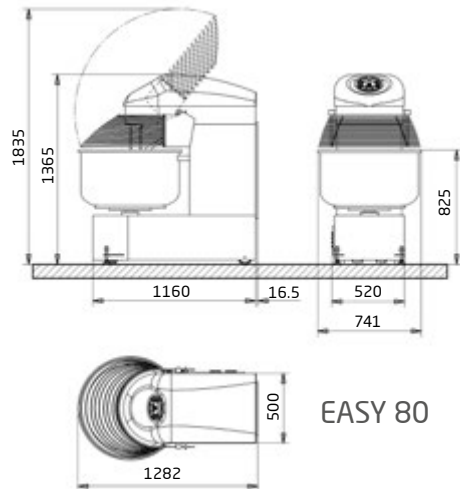

EASY 80



MODELO / MODÈLE / MODELO / MODEL	EASY 50
CÓDIGO / CODE / CÓDIGO / CODE	2522.018A
<b>Preço / Prix / Precio / Price</b>	€ <b>15.139,00</b>
Dimensões / Dimensions / Dimensiones	mm 630x 1176x 1316/1675
Capacidade da Cuba /Capacité cuve /Capacidad cuba /Vat capacity	Lt 80
Dimensão da Cuba / Dimension cuve / Dimension de la cuba / Vat dimension	Ømm 600x360
Capacidade de massa /Capacité pâte /Capacidad masa /Dough capacity	kg 50
Rot. espiral 1a velocidade / Rot. spirale 1ème vitesse / Rot. espiral 1a velocidad / 1st speed spiral rot.	rpm 111
Rot. espiral 2a velocidade / Rot. spirale 2ème vitesse / Rot. espiral 2a velocidad / 2nd speed spiral rot.	rpm 222
Velocidade rotação da Cuba / Vel. rotation cuve /Vel. Rotación cuba /Speed vat rotation	13
Peso Líquido-Bruto /Poids Net-Brut /Peso Neto-Bruto /Net-Gross Weight	kg 293
Potência / Puissance / Potencia / Power	kW 2,6
Tensão / Tension / Tensión / Tension	V 400

MODELO / MODÈLE / MODELO / MODEL	EASY 80
CÓDIGO / CODE / CÓDIGO / CODE	2522.019
<b>Preço / Prix / Precio / Price</b>	€ <b>16.215,00</b>
Dimensões / Dimensions / Dimensiones	mm 741x 1282x 1365/1385
Capacidade da Cuba /Capacité cuve /Capacidad cuba /Vat capacity	Lt 148
Dimensão da Cuba / Dimension cuve / Dimension de la cuba / Vat dimension	Ømm 700x400
Capacidade de massa /Capacité pâte /Capacidad masa /Dough capacity	kg 80
Rot. espiral 1a velocidade / Rot. spirale 1ème vitesse / Rot. espiral 1a velocidad / 1st speed spiral rot.	rpm 103,5
Rot. espiral 2a velocidade / Rot. spirale 2ème vitesse / Rot. espiral 2a velocidad / 2nd speed spiral rot.	rpm 207
Velocidade rotação da Cuba / Vel. rotation cuve /Vel. Rotación cuba /Speed vat rotation	11
Peso Líquido-Bruto /Poids Net-Brut /Peso Neto-Bruto /Net-Gross Weight	kg 398
Potência / Puissance / Potencia / Power	kW 4,6
Tensão / Tension / Tensión / Tension	V 400



UDI

**AMASSADEIRAS VERTICAIS**  
PÉTRINS VERTICAIS  
AMASADORAS VERTICALES  
VERTICAL KNEADERS



O painel de Controlo multifunção permite tanto o modo manual tradicional como o modo automático programável, automatizando todas as operações cíclicas. Dois motores independentes para a espiral e para a cuba. As ferramentas que estão em contacto com os alimentos (cuba, espiral e barra de quebrar a massa) são de aço inoxidável AISI 304. A pedido pode-se fornecer a tampa de proteção ABS ao invés da grelha de proteção de aço inox.



Le panneau de commande multifonction permet à la fois le mode manuel traditionnel et le mode automatique programmable, automatiser toutes les opérations cycliques. Deux moteurs indépendants pour la spirale et la cuve. Pièces en contact avec les aliments (cuve, spirale et brise-pâte) en acier inox AISI 304. Sur demande nous pouvons fournir le couvercle de protection ABS au lieu de la grille de protection en acier inoxydable.



El panel de control multifunción permite tanto el modo manual tradicional como el modo automático programable, automatizar todas operaciones cíclicas. Dos motores independientes para la espiral y la cuba. Partes en contacto con los alimentos (cuba, espiral y barra para romper la masa) de acero inoxidable AISI 304. A solicitud es posible proveer una tapa de protección ABS en lugar de la rejilla de protección en acero inoxidable.



The multifunction control panel allows both the traditional manual mode and the automatic programmable mode, automate all cyclic operations. Two independent motors for the spiral and the bowl. Parts in contact with food (bowl, spiral and kneader rod) made of AISI 304 stainless steel. On request can be supplied a ABS safety cover instead of the stainless steel guard.

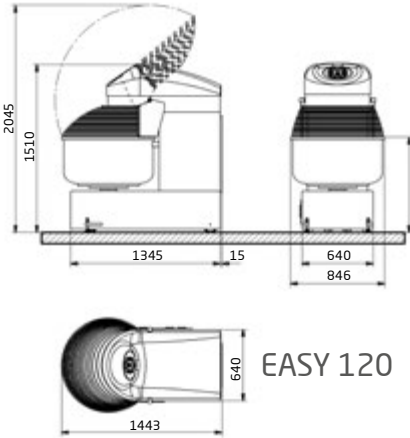

EASY 120

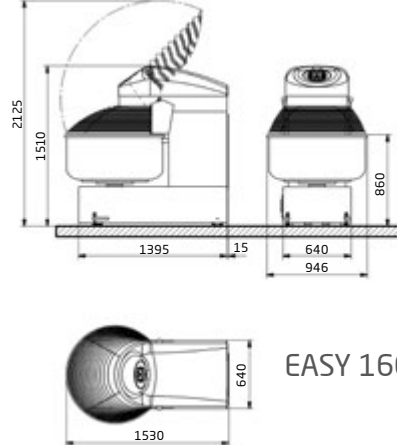

EASY 160

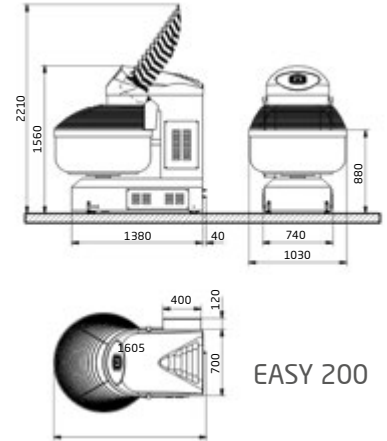

EASY 200



MODELO / MODÈLE / MODELO / MODEL	EASY 120
CÓDIGO / CODE / CÓDIGO / CODE	2522.019A
<b>Preço / Prix / Precio / Price</b>	<b>€ 18.145,00</b>
Dimensões / Dimensions / Dimensiones	mm 846x 1443x 1510/2045
Capacidade da Cuba / Capacité cuve / Capacidad cuba / Vat capacity	Lt 203
Dimensão da Cuba / Dimension cuve / Dimension de la cuba / Vat dimension	Ømm 800x400
Capacidade de massa / Capacité pâte / Capacidad masa / Dough capacity	kg 120
Rot. espiral 1a velocidade / Rot. spirale 1ème vitesse / Rot. espiral 1a velocidad / 1st speed spiral rot.	rpm 101
Rot. espiral 2a velocidade / Rot. spirale 2ème vitesse / Rot. espiral 2a velocidad / 2nd speed spiral rot.	rpm 202
Velocidade rotação da Cuba / Vel. rotation cuve / Vel. Rotación cuba / Speed vat rotation	11
Peso Líquido-Bruto / Poids Net-Brut / Peso Neto-Bruto / Net-Gross Weight	kg 568
Potência / Puissance / Potencia / Power	kW 6,7
Tensão / Tension / Tensión / Tension	V 400
MODELO / MODÈLE / MODELO / MODEL	EASY 160
CÓDIGO / CODE / CÓDIGO / CODE	2522.019B
<b>Preço / Prix / Precio / Price</b>	<b>€ 20.593,00</b>
Dimensões / Dimensions / Dimensiones	mm 946x 1530x 1510/2125
Capacidade da Cuba / Capacité cuve / Capacidad cuba / Vat capacity	Lt 261
Dimensão da Cuba / Dimension cuve / Dimension de la cuba / Vat dimension	Ømm 900x420
Capacidade de massa / Capacité pâte / Capacidad masa / Dough capacity	kg 160
Rot. espiral 1a velocidade / Rot. spirale 1ème vitesse / Rot. espiral 1a velocidad / 1st speed spiral rot.	rpm 101
Rot. espiral 2a velocidade / Rot. spirale 2ème vitesse / Rot. espiral 2a velocidad / 2nd speed spiral rot.	rpm 202
Velocidade rotação da Cuba / Vel. rotation cuve / Vel. Rotación cuba / Speed vat rotation	11
Peso Líquido-Bruto / Poids Net-Brut / Peso Neto-Bruto / Net-Gross Weight	kg 593
Potência / Puissance / Potencia / Power	kW 8,2
Tensão / Tension / Tensión / Tension	V 400
MODELO / MODÈLE / MODELO / MODEL	EASY 200
CÓDIGO / CODE / CÓDIGO / CODE	2522.019C
<b>Preço / Prix / Precio / Price</b>	<b>€ 22.705,00</b>
Dimensões / Dimensions / Dimensiones	mm 1030x 1605x 1560/2210
Capacidade da Cuba / Capacité cuve / Capacidad cuba / Vat capacity	Lt 331
Dimensão da Cuba / Dimension cuve / Dimension de la cuba / Vat dimension	Ømm 1000x440
Capacidade de massa / Capacité pâte / Capacidad masa / Dough capacity	kg 200
Rot. espiral 1a velocidade / Rot. spirale 1ème vitesse / Rot. espiral 1a velocidad / 1st speed spiral rot.	rpm 92
Rot. espiral 2a velocidade / Rot. spirale 2ème vitesse / Rot. espiral 2a velocidad / 2nd speed spiral rot.	rpm 184
Velocidade rotação da Cuba / Vel. rotation cuve / Vel. Rotación cuba / Speed vat rotation	10
Peso Líquido-Bruto / Poids Net-Brut / Peso Neto-Bruto / Net-Gross Weight	kg 710
Potência / Puissance / Potencia / Power	kW 8,5
Tensão / Tension / Tensión / Tension	V 400

**DESCARGA NA MESA**  
 Décharger sur la table  
 Descargar en la mesa  
 Unloading on the table



EASY 120 RL

EASY 250 RL

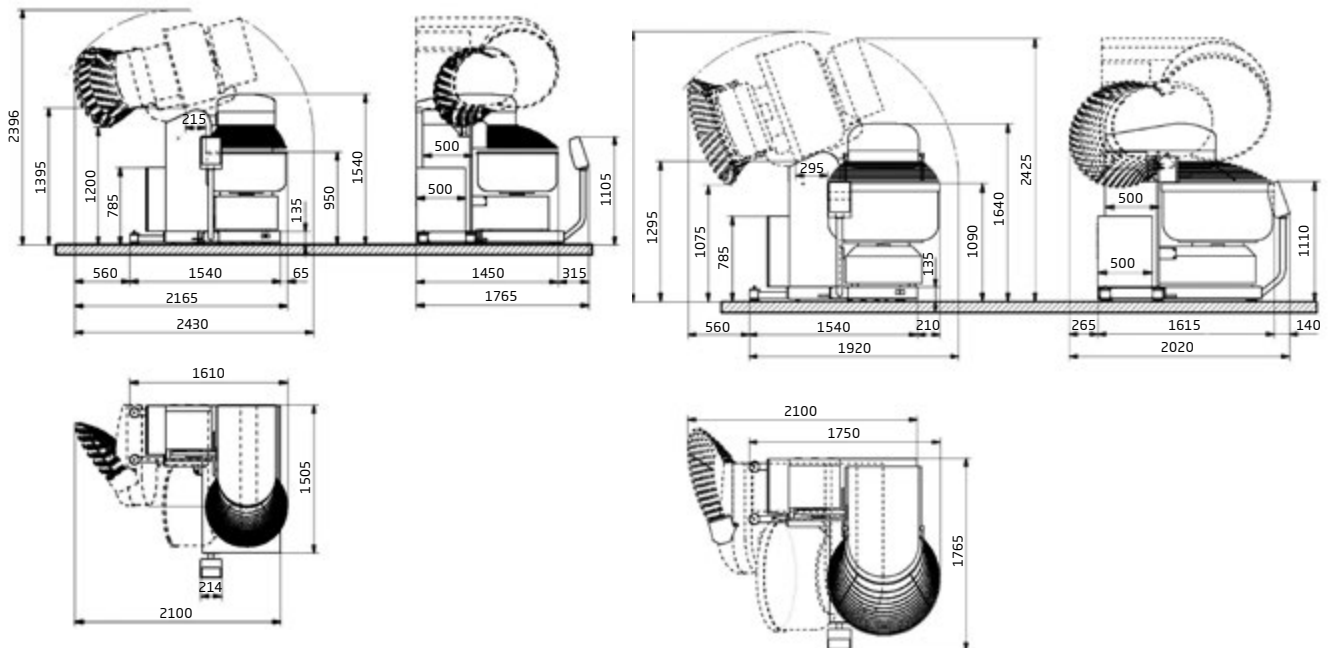

MODELO / MODÈLE / MODELO / MODEL	EASY 120 RL	EASY 160 RL	EASY 200 RL	EASY 250 RL
CÓDIGO / CODE / CÓDIGO / CODE	2522.200	2522.202	2522.204	2522.206
<b>Preço / Prix / Precio / Price</b>	<b>€ 38.990,00</b>	<b>41.127,00</b>	<b>45.402,00</b>	<b>46.698,00</b>
Capacidade da Cuba /Capacité cuve /Capacidad cuba /Vat capacity	Lt 203	261	331	393
Dimensão da Cuba / Dimension cuve / Dimension de la cuba / Vat dimension	Ømm 800x400	900x420	1000x440	1000x520
Capacidade de massa /Capacité pâte /Capacidad masa /Dough capacity	kg 120	160	200	250
Rot. espiral 1a velocidade / Rot. spirale 1ème vitesse / Rot. espiral 1a velocidad / 1st speed spiral rot.	rpm 101	101	92	92
Rot. espiral 2a velocidade / Rot. spirale 2ème vitesse / Rot. espiral 2a velocidad / 2nd speed spiral rot.	rpm 202	202	184	184
Peso Líquido-Bruto /Poids Net-Brut /Peso Neto-Bruto /Net-Gross Weight	kg 1025	1096	1189	1226
Potência / Puissance / Potencia / Power	kw 6,7	8,2	8,5	8,5
Tensão / Tension / Tensión / Tension	V 400	400	400	400



UDI

**AMASSADEIRAS COM ELEVAÇÃO**  
 PÉTRINS AVEC ELÉVATION  
 AMASADORAS CON ELEVACIÓN  
 KNEADING WITH ELEVATION



**DESCARGA ATÉ 1,8 METROS**  
 Décharger jusqu'à 1,8 metres  
 Descarga hasta 1,8 metros  
 Unloading up to 1,8 meters

EASY 120 RH

EASY 250 RH

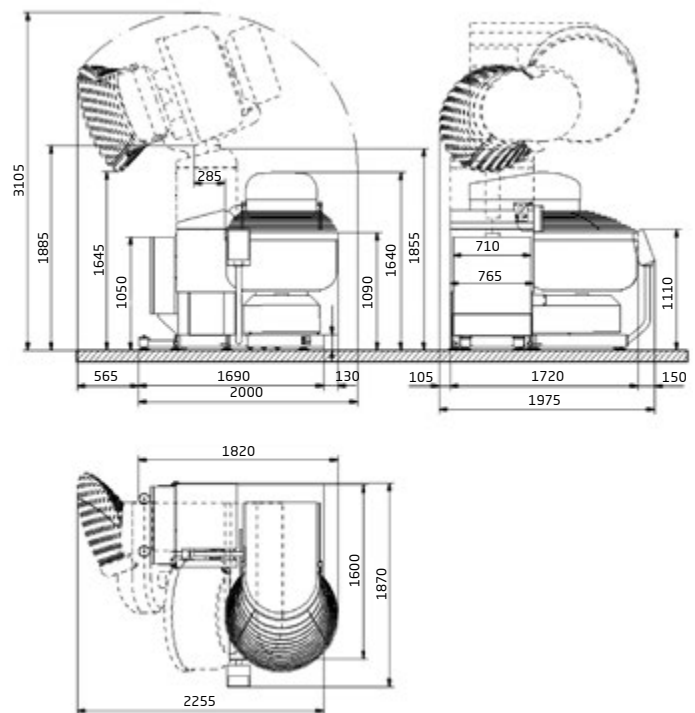
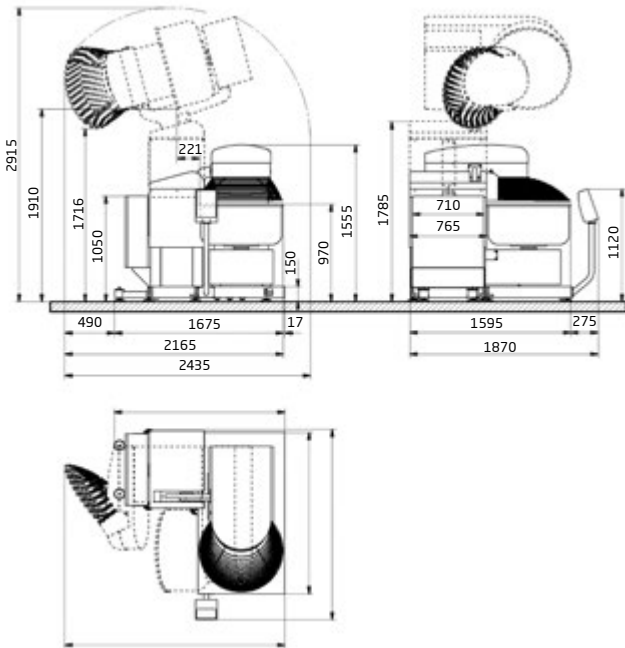

MODELO / MODÈLE / MODELO / MODEL	EASY 120 RH	EASY 160 RH	EASY 200 RH	EASY 250 RH
CÓDIGO / CODE / CÓDIGO / CODE	2522.208	2522.210	2522.212	2522.214
Preço / Prix / Precio / Price	€ 43.977,00	46.050,00	52.463,00	53.953,00
Capacidade da Cuba / Capacité cuve / Capacidad cuba / Vat capacity	Lt 203	261	331	393
Dimensão da Cuba / Dimension cuve / Dimension de la cuba / Vat dimension	Ømm 800x400	900x420	1000x440	1000x520
Capacidade de massa / Capacité pâte / Capacidad masa / Dough capacity	kg 120	160	200	250
Rot. espiral 1a velocidade / Rot. spirale 1ème vitesse / Rot. espiral 1a velocidad / 1st speed spiral rot.	rpm 101	101	92	92
Rot. espiral 2a velocidade / Rot. spirale 2ème vitesse / Rot. espiral 2a velocidad / 2nd speed spiral rot.	rpm 202	202	184	184
Peso Líquido-Bruto / Poids Net-Brut / Peso Neto-Bruto / Net-Gross Weight	kg 1288	1313	1430	1487
Potência / Puissance / Potencia / Power	kW 6,7	8,2	8,5	8,5
Tensão / Tension / Tensión / Tension	V 400	400	400	400



Máquina para esticar massa de pizza, pão, tortilhas, etc.  
 Toda a estrutura em aço inoxidável.  
 Alavanca de ajuste da espessura da massa em ambos os rolos.



Máquina para estirar masa de pizza, pan, tortilla, etc.  
 Estructura completamente de acero inoxidable.  
 Palanca de ajuste del grosor de la masa en los dos rodillos.



Machine pour étendre les pâtes à pizza, pain, piada, fougasse, etc.  
 Châssis entièrement en acier inox  
 Levier de réglage d'épaisseur de la pâte sur les deux rouleaux.



Pizza and bread dough rolling machine.  
 Structure fully made of stainless steel  
 Thickness adjustment lever of the dough on both rollers.



MODELO / MODÈLE / MODELO / MODEL	FI/32 PVC
CÓDIGO / CODE / CÓDIGO / CODE	2088.374
<b>Preço / Prix / Precio / Price</b>	<b>€ 1.940,00</b>
Dimensões / Dimensions / Dimensiones	mm 490x510x640
Comprimento do rolo / Longueur du rouleau / Longitud del rodillo / Roll length	mm 320
Abertura dos cilindros / Ouverture des cylindres / Abertura de los cilindros / Opening cylinders	mm Min 0,3 Max 5,5
Peso Líquido / Poids Net / Peso Neto / Net Weight	kg 36
Potência / Puissance / Potencia / Power	kW 0,37
Tensão / Tension / Tensión / Tension	V 230

MODELO / MODÈLE / MODELO / MODEL	FI/42 PVC
CÓDIGO / CODE / CÓDIGO / CODE	2088.372
<b>Preço / Prix / Precio / Price</b>	<b>€ 2.147,00</b>
Dimensões / Dimensions / Dimensiones	mm 590x510x760
Comprimento do rolo / Longueur du rouleau / Longitud del rodillo / Roll length	mm 420
Abertura dos cilindros / Ouverture des cylindres / Abertura de los cilindros / Opening cylinders	mm Min 0,3 Max 5,5
Peso Líquido / Poids Net / Peso Neto / Net Weight	kg 44
Potência / Puissance / Potencia / Power	kW 0,37
Tensão / Tension / Tensión / Tension	V 230

MODELO / MODÈLE / MODELO / MODEL	FIP/42 PVC
CÓDIGO / CODE / CÓDIGO / CODE	2088.376
<b>Preço / Prix / Precio / Price</b>	<b>€ 2.211,00</b>
Dimensões / Dimensions / Dimensiones	mm 590x510x700
Comprimento do rolo / Longueur du rouleau / Longitud del rodillo / Roll length	mm 420
Abertura dos cilindros / Ouverture des cylindres / Abertura de los cilindros / Opening cylinders	mm Min 0,3 Max 5,5
Peso Líquido / Poids Net / Peso Neto / Net Weight	kg 45
Potência / Puissance / Potencia / Power	kW 0,37
Tensão / Tension / Tensión / Tension	V 230



Cód.	Desc.	€
2088.390	PEDAL / PÉDALE / PEDAL / PEDAL	117,00



MODELO / MODÈLE / MODELO / MODEL	UDIEM400
CÓDIGO / CODE / CÓDIGO / CODE	5200.125
<b>Preço / Prix / Precio / Price</b>	<b>€ 1.875,00</b>
Dimensões / Dimensions / Dimensiones	mm 530X550X650
Comprimento do rolo / Longueur du rouleau / Longitud del rodillo / Roll length	mm 400
Abertura dos cilindros / Ouverture des cylindres / Abertura de los cilindros / Opening cylinders	mm -
Peso Líquido / Poids Net / Peso Neto / Net Weight	kg 37
Potência / Puissance / Potencia / Power	kW 0,25
Tensão / Tension / Tensión / Tension	V 230





UDI

FORMADORAS DE PIZZA  
FORMEUSES DE PIZZA  
FORMADORAS DE PIZZA  
PIZZAFORMS



Elevada produção horária - até 400 pizzas por hora.  
Uniformidade perfeita de forma e espessura da base da pizza.  
Espessura da base da pizza ajustável.  
Fabricado inteiramente em aço inoxidável.



Alta producción horaria - hasta 400 pizzas por hora.  
Uniformidad perfecta de la forma y espesor de la base de la pizza.  
Espesor de la base de la pizza ajustable.  
Fabricado totalmente en acero inoxidable.



Éleve production horaire - jusqu'à 400 pizzas par heure.  
Uniformité parfaite de la forme et de l'épaisseur du fond à pizza.  
Épaisseur de la base de la pizza réglable.  
Fabriqué entièrement en acier inoxydable.



High hourly output - up to 400 pizzas per hour.  
Perfect uniformity, shape and thickness of the pizza bases.  
Thickness of the bases can be easily adjusted.  
Produced completely in stainless steel.



MODELO / MODÈLE / MODELO / MODEL	PZF30D	PZF35D
CÓDIGO / CODE / CÓDIGO / CODE	2110.165	2110.175
Preço / Prix / Precio / Price	€ 7.743,00	7.839,00
Dimensões / Dimensions / Dimensiones	mm 500x610x770	500x610x770
Peso Líquido / Poids Net / Peso Neto / Net Weight	kg 143	147
Potência / Puissance / Potencia / Power	kW 2,9	2,9
Tensão / Tension / Tensión / Tension	V 400	400



MODELO / MODÈLE / MODELO / MODEL	PZF40D	PZF45D
CÓDIGO / CODE / CÓDIGO / CODE	2110.178	2110.180
Preço / Prix / Precio / Price	€ 10.034,00	10.160,00
Dimensões / Dimensions / Dimensiones	mm 550x710x845	550x710x845
Peso Líquido / Poids Net / Peso Neto / Net Weight	kg 186	191
Potência / Puissance / Potencia / Power	kW 3,9	4,6
Tensão / Tension / Tensión / Tension	V 400	400



MODELO / MODÈLE / MODELO / MODEL	PZF50D
CÓDIGO / CODE / CÓDIGO / CODE	2110.185
Preço / Prix / Precio / Price	€ 10.288,00
Dimensões / Dimensions / Dimensiones	mm 550x710x845
Peso Líquido / Poids Net / Peso Neto / Net Weight	kg 196
Potência / Puissance / Potencia / Power	kW 4,6
Tensão / Tension / Tensión / Tension	V 400



**FORMAS DE PIZZA**  
MOULES À PIZZA  
MOLDES DE PIZZA  
PIZZA FORMS

Cód.	Ref.	€
2110.190	22 Cm	4,00
2110.192	24 Cm	4,00
2110.194	26 Cm	5,00
2110.196	28 Cm	6,00
2110.198	30 Cm	6,00
2110.204	36 Cm	7,00
2110.206	45 Cm	18,00



confirmar disponibilidade  
confirmer la disponibilité  
confirmar la disponibilidad  
confirm the availability



opcional  
optionnel  
opcional  
optional



Máquina para amassar e extrudir massa de ovo em diferentes formatos.  
Cuba e gancho de amassar a massa em aço inoxidável.  
Micro interruptor na tampa da cuba.  
Lâmina em liga de bronze/latão.  
Acessórios: Discos em metal com diferentes formas.



Machine à pétrir et extruder la pâte aux oeufs dans différents formats.  
Cuve à crochet pétriseur en acier inoxydable.  
Micro-interrupteur sur le couvercle de la cuve.  
Hélice en alliage bronze/laiton  
Accessoires: Disques métalliques avec différents formes.



Máquina para amasar y extrudir masas de huevos en diferentes formatos.  
Cuba y gancho amasador de acero inoxidable.  
Micro interruptor en la tampa de la cuba.  
Hélice de aleación de bronce/latón.  
Accesorios: Discos de metal con formatos diferentes.



Machine to knead and extrude egg pasta in different shapes.  
Stainless steel bowl and kneader.  
Micro switch on basin lid.  
Bronze/brass alloy blade.  
Accessories: Metal discs with different shapes.

**MOLDES MASSA NÃO INCLUIDOS**

MOULES NON INCLUS  
MOLDES NO INCLUIDOS  
PASTA MOLDS NOT INCLUDED



MODELO / MODÈLE / MODELO / MODEL	MPF 1,5N
CÓDIGO / CODE / CÓDIGO / CODE	2088.152
<b>Preço / Prix / Precio / Price</b>	<b>€ 1.831,00</b>
Dimensões / Dimensions / Dimensiones	mm 250x 480x 290/460
Capacidade da Cuba /Capacité cuve /Capacidad cuba /Vat capacity	kg 1,5
Capacidade de massa /Capacité pâte /Capacidad masa /Dough capacity	kg 5
Diâmetro do Disco / Diamètre du disque / Diámetro del disco / Disc diameter	Ømm 50
Peso Líquido-Bruto /Poids Net-Brut /Peso Neto-Bruto /Net-Gross Weight	kg 18 - 20
Potência / Puissance / Potencia / Power	kW 0,3
Tensão / Tension / Tensión / Tension	V 230



MODELO / MODÈLE / MODELO / MODEL	MPF 2,5N
CÓDIGO / CODE / CÓDIGO / CODE	2088.162
<b>Preço / Prix / Precio / Price</b>	<b>€ 2.710,00</b>
Dimensões / Dimensions / Dimensiones	mm 260x 600x 380/560
Capacidade da Cuba /Capacité cuve /Capacidad cuba /Vat capacity	kg 2,5
Capacidade de massa /Capacité pâte /Capacidad masa /Dough capacity	kg 8
Diâmetro do Disco / Diamètre du disque / Diámetro del disco / Disc diameter	Ømm 57
Peso Líquido-Bruto /Poids Net-Brut /Peso Neto-Bruto /Net-Gross Weight	kg 29 - 38
Potência / Puissance / Potencia / Power	kW 0,37
Tensão / Tension / Tensión / Tension	V 230



MODELO / MODÈLE / MODELO / MODEL	PF25E 230V	PF25E 400V
CÓDIGO / CODE / CÓDIGO / CODE	2088.730	2088.734
<b>Preço / Prix / Precio / Price</b>	<b>€ 2.610,00</b>	<b>2.647,00</b>
Dimensões / Dimensions / Dimensiones	mm 300x550x425/540	300x550x425/540
Capacidade da Cuba /Capacité cuve /Capacidad cuba /Vat capacity	kg 2	2
Capacidade de massa /Capacité pâte /Capacidad masa /Dough capacity	kg 8	8
Diâmetro do Disco / Diamètre du disque / Diámetro del disco / Disc diameter	Ømm 57	57
Peso Líquido-Bruto /Poids Net-Brut /Peso Neto-Bruto /Net-Gross Weight	kg 26,5-33,5	26,5-33,5
Potência / Puissance / Potencia / Power	kW 0,37	0,37
Tensão / Tension / Tensión / Tension	V 230	400



MODELO / MODÈLE / MODELO / MODEL	PF40E 230V	PF40E 400V
CÓDIGO / CODE / CÓDIGO / CODE	2088.738	2088.742
<b>Preço / Prix / Precio / Price</b>	<b>€ 4.344,00</b>	<b>4.410,00</b>
Dimensões / Dimensions / Dimensiones	mm 307X594X525/610	307X594X525/610
Capacidade da Cuba /Capacité cuve /Capacidad cuba /Vat capacity	kg 3,5	3,5
Capacidade de massa /Capacité pâte /Capacidad masa /Dough capacity	kg 13	13
Diâmetro do Disco / Diamètre du disque / Diámetro del disco / Disc diameter	Ømm 57	57
Peso Líquido-Bruto /Poids Net-Brut /Peso Neto-Bruto /Net-Gross Weight	kg 35-46	35-46
Potência / Puissance / Potencia / Power	kW 0,75	0,75
Tensão / Tension / Tensión / Tension	V 230	230



PF40E: Incluído / Included  
PF25E: Opcional / Optional

Cód.	Ref	€
2088.744	FACA DE CORTE P/ PF25E CUTTER FOR P/ PF25E	<b>763,00</b>



opcional  
opcionnel  
opcional  
optional



UDI

**MOLDES PARA MASSA FRESCA**  
MOULES MACHINE A PÂTE FRAICHE  
MOLDES MÁQUINA PARA MASA FRESCA  
MOLDS FRESH PASTA MACHINE



DIM.	ø 4,8 mm	ø 4,8 mm	
Cód.	Ref	€	
2088.175	MOLDE MACCHERONI DIAMETRO 4,8 P/MPF 2,5N	95,00	



DIM.	ø8,5 mm	ø8,5 mm	
Cód.	Ref	€	
2088.156	MOLDE MACCHERONI P/MPF1,5N	78,00	
2088.164	MOLDE MACCHERONI P/MPF2,5N	95,00	



DIM.	ø15mm		
Cód.	Ref	€	
2088.164A	MOLDE MACCHERONI DIAMETRO 15 MODELOS 2.5/4	95,00	



DIM.			
Cód.	Ref	€	
2088.158B	MOLDE CANNELLONE MODELO MPF 1,5N	78,00	



DIM.			
Cód.	Ref	€	
2088.151	MOLDE GNOCCHI MPF 1,5N CE	78,00	
2088.171	MOLDE GNOCHI P/MPF 2,5N	95,00	



DIM.			
Cód.	Ref	€	
2088.172	MOLDE BUCATINI P/MPF 2,5N	95,00	



DIM.			
Cód.	Ref	€	
2088.170	MOLDE GRAMIGNA P/MPF2,5N	95,00	

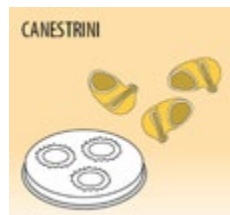

DIM.			
Cód.	Ref	€	
2088.161	MOLDE CANESTRINI DIAM.16 mm P/MPF1,5N	78,00	



DIM.	9 X 5mm mm		
Cód.	Ref	€	
2088.151A	MOLDE CASERECCHE - MPF 1,5 N	78,00	
2088.167	MOLDE CASERECCHE P/MPF2,5N	95,00	

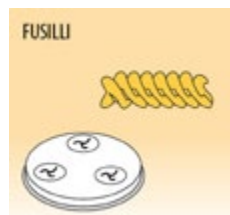

DIM.	ø 9mm	ø 9mm	
Cód.	Ref	€	
2088.154	MOLDE FUSILLI P/ MPF1,5N	78,00	
2088.163	MOLDE FUSILLI P/ MPF2,5N	95,00	





DIM. 2x2 mm

Cód.	Ref	€
2088.161A	MOLDE SPAGHETTI ALLA CHITARRA MPF 1,5N	78,00
2088.176A	MOLDE SPAGHETTI ALLA CHITARRA PARA MODELOS 2,5/4	95,00

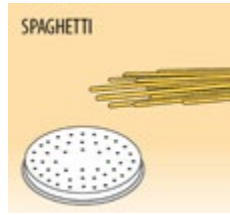

DIM. ø2 mm

Cód.	Ref	€
2088.160	MOLDE SPAGHETTI P/ MPF1,5N	78,00
2088.166	MOLDE SPAGHETTI P/ MPF2,5N	95,00

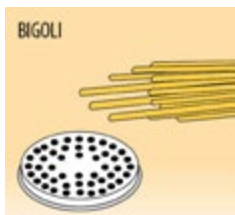

DIM.

Cód.	Ref	€
2088.153	MOLDE BIGOLI P/ MPF 1,5N	78,00

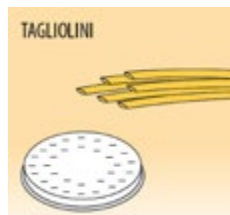

DIM. 3mm

Cód.	Ref	€
2088.158A	MOLDE TAGLIOLINI MODELO MPF1,5N	78,00
2088.173	MOLDE TAGLIOLINI P/MPF 2,5N	95,00

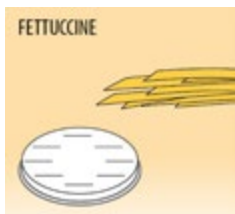

DIM. 8 mm

Cód.	Ref	€
2088.158	MOLDE FETTUCCINE P/ MPF1,5N	78,00
2088.165	MOLDE FETTUCCINE P/ MPF2,5N	95,00

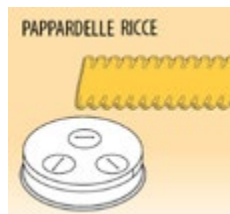

DIM. 16mm

Cód.	Ref	€
2088.155	MOLDE PAPPARDELLE MFF 1,5N CE	78,00
2088.168	MOLDE PAPPARDELLE RICE P/ MPF 2,5N	95,00



DIM.

Cód.	Ref	€
2088.157	MOLDE SFLOGIA MPF 1,5N CE	116,00
2088.159	MOLDE LASAGNA P/ MPF2,5N	117,00
2088.176	MOLDE PASTA SFOGLIA P/MPF 2,5N	117,00



DIM.

Cód.	Ref	€
2088.169	MOLDE RISO P/MPF 2,5N	95,00



UDI

**BATEDEIRAS PARA MASSAS FINAS**  
MÉLANGEURS POUR PÂTE FINE  
BATIDORES PARA MASAS FINAS  
MIXERS FOR FINE DOUGH



Três velocidades fixas excecpto 5 lt. Engrenagens e eixos em liga de aço temperado. Transmissão lubrificada permanentemente. Proteção em caso de sobrecarga térmica. Temporizador de 15 min. Todas as máquinas incluem 1 tina, 1 gancho, 1 espátula e 1 pinha. Excecpto o modelo SP500A 5L (com velocidades variáveis).



Trois vitesses fixes excecpté 5 lt. Arbres et transmission en acier allié trempé. Lubrifié transmission permanente. Protection en cas de surcharge thermique Minuteur 15 min. Toutes les machines incluent 1 cuve, 1 crochet, 1 spatule et 1 caboche. A l' exception de modèle SP500A 5L. (avec des vitesses variables).



Tres velocidades fijas excecpto 5 lt. Engranajes y ejes en aleación de acero templado. Transmisión permanentemente lubrificada. Protección en caso de sobrecarga térmica. Temporizador de 15 min. Todas las máquinas incluyen 1 cuba, 1 gancho, 1 espátula y 1 pinha. Excecpto el modelo SP500A 5L (con velocidades variables).



Three fixed speeds excecpto 5 lt. Heat-treated hardened steel alloy gears and shafts. Permanently lubricated transmission. Thermal overload protection . 15 min. timer. All machines include 1 vat, 1 hook, 1 spatula and 1 heap. Except SP500A 5L model. (with variable speeds).

Alta qualidade  
Haute qualité  
Alta calidad  
High quality



MODELO / MODÈLE / MODELO / MODEL	SP 500A 230V	
CÓDIGO / CODE / CÓDIGO / CODE	2521.405	
<b>Preço / Prix / Precio / Price</b>	€	<b>1.178,00</b>
Dimensões / Dimensions / Dimensiones	mm	400x 310x 455
Capacidade da Cuba /Capacité cuve /Capacidad cuba /Vat capacity	Lt	5
Capacidade de massa /Capacité pâte /Capacidad masa /Dough capacity	kg	1
Velocidade / Vitesse / Velocidad / Speed	rpm	40-260
Peso Líquido-Bruto /Poids Net-Brut /Peso Neto-Bruto /Net-Gross Weight	kg	15/16
Potência / Puissance / Potencia / Power	hp	1
Tensão / Tension / Tensión / Tension	V	230



MODELO / MODÈLE / MODELO / MODEL	SP 800A 230V	
CÓDIGO / CODE / CÓDIGO / CODE	2521.412	
<b>Preço / Prix / Precio / Price</b>	€	<b>1.564,00</b>
Dimensões / Dimensions / Dimensiones	mm	470x 280x 580
Capacidade da Cuba /Capacité cuve /Capacidad cuba /Vat capacity	Lt	8
Capacidade de massa /Capacité pâte /Capacidad masa /Dough capacity	kg	1,4
Velocidade / Vitesse / Velocidad / Speed	rpm	132/ 234/ 421
Peso Líquido-Bruto /Poids Net-Brut /Peso Neto-Bruto /Net-Gross Weight	kg	25/27
Potência / Puissance / Potencia / Power	hp	1/4
Tensão / Tension / Tensión / Tension	V	230



MODELO / MODÈLE / MODELO / MODEL	SP 100A 230V	
CÓDIGO / CODE / CÓDIGO / CODE	2521.415	
<b>Preço / Prix / Precio / Price</b>	€	<b>2.716,00</b>
Dimensões / Dimensions / Dimensiones	mm	460x 450x 760
Capacidade da Cuba /Capacité cuve /Capacidad cuba /Vat capacity	Lt	10
Capacidade de massa /Capacité pâte /Capacidad masa /Dough capacity	kg	3,4
Velocidade / Vitesse / Velocidad / Speed	rpm	106/ 196/ 358
Peso Líquido-Bruto /Poids Net-Brut /Peso Neto-Bruto /Net-Gross Weight	kg	65/-
Potência / Puissance / Potencia / Power	hp	1/3
Tensão / Tension / Tensión / Tension	V	230



MODELO / MODÈLE / MODELO / MODEL	SP 40 HA 400V	SP 60 HA 400V
CÓDIGO / CODE / CÓDIGO / CODE	2521.435	2521.440
<b>Preço / Prix / Precio / Price</b>	€	<b>7.747,00</b>
Dimensões / Dimensions / Dimensiones	mm	750x 650x 1310
Capacidade da Cuba /Capacité cuve /Capacidad cuba /Vat capacity	Lt	40
Capacidade de massa /Capacité pâte /Capacidad masa /Dough capacity	kg	18,1
Velocidade / Vitesse / Velocidad / Speed	rpm	99/ 176/ 320
Peso Líquido-Bruto /Poids Net-Brut /Peso Neto-Bruto /Net-Gross Weight	kg	250/-
Potência / Puissance / Potencia / Power	hp	1,5
Tensão / Tension / Tensión / Tension	V	400

BATEDEIRAS - ACESSÓRIOS E OPCIONAIS / BATTEURS - ACCESSOIRES ET OPTIONNELS / BATIDORAS - ACCESORIOS Y OPCIONALES - MIXER - OPTIONALS AND SPARE PARTS - 328



**NOVO  
NOUVEAU  
NUEVO  
NEW**



MODELO / MODÈLE / MODELO / MODEL	AP10L	
CÓDIGO / CODE / CÓDIGO / CODE	2521.715	
<b>Preço / Prix / Precio / Price</b>	€	<b>2.320,00</b>
Dimensões / Dimensions / Dimensiones	mm	400x490x780
Capacidade da Cuba / Capacité cuve / Capacidad cuba / Vat capacity	Lt	10
Dimensão da Cuba / Dim. cuve / Dim. cuba / Vat dim.	Ø x ↑ mm	245x240
Velocidade / Vitesse / Velocidad / Speed	rpm	1º=118 2º=234 3º=460
Peso Líquido-Bruto / Poids Net-Brut / Peso Neto-Bruto / Net-Gross Weight	kg	64-74
Potência / Puissance / Potencia / Power	kW	0,6
Tensão / Tension / Tensión / Tension	V	230

**NOVO  
NOUVEAU  
NUEVO  
NEW**



MODELO / MODÈLE / MODELO / MODEL	AP20L	
CÓDIGO / CODE / CÓDIGO / CODE	2521.710	
<b>Preço / Prix / Precio / Price</b>	€	<b>2.574,00</b>
Dimensões / Dimensions / Dimensiones	mm	480x590x930
Capacidade da Cuba / Capacité cuve / Capacidad cuba / Vat capacity	Lt	20
Dimensão da Cuba / Dim. cuve / Dim. cuba / Vat dim.	Ø x ↑ mm	315x280
Velocidade / Vitesse / Velocidad / Speed	rpm	1º=118 2º=234 3º=460
Peso Líquido-Bruto / Poids Net-Brut / Peso Neto-Bruto / Net-Gross Weight	kg	84-108
Potência / Puissance / Potencia / Power	kW	0,9
Tensão / Tension / Tensión / Tension	V	400



UDI



**BATEDEIRAS PARA MASSAS FINAS**  
MÉLANGEURS POUR PÂTE FINE  
BATIDORES PARA MASAS FINAS  
MIXERS FOR FINE DOUGH



Alta qualidade  
Haute qualité  
Alta calidad  
High quality



MODELO / MODÈLE / MODELO / MODEL		BA20-F	BA20-F
CÓDIGO / CODE / CÓDIGO / CODE		2521.441	2521.442
<b>Preço / Prix / Precio / Price</b>	€	<b>2.518,00</b>	<b>2.518,00</b>
Dimensões / Dimensions / Dimensiones	mm	460x550x830	460x550x830
Capacidade da Cuba / Capacité cuve / Capacidad cuba / Vat capacity	Lt	20	20
Dimensão da Cuba / Dim. cuve / Dim. cuba / Vat dim.	Ømm	340x300	340x300
Capacidade de massa / Capacité pâte / Capacidad masa / Dough capacity	kg	4,6	4,6
Velocidade / Vitesse / Velocidad / Speed	kg	106/205/395	106/205/395
Peso Líquido-Bruto / Poids Net-Brut / Peso Neto-Bruto / Net-Gross Weight	kg	94	94
Potência / Puissance / Potencia / Power	kW	1/2hp	1/2hp
Tensão / Tension / Tensión / Tension	V	230	400



MODELO / MODÈLE / MODELO / MODEL		BA30-F
CÓDIGO / CODE / CÓDIGO / CODE		2521.444
<b>Preço / Prix / Precio / Price</b>	€	<b>4.335,00</b>
Dimensões / Dimensions / Dimensiones	mm	680x610x1070
Capacidade da Cuba / Capacité cuve / Capacidad cuba / Vat capacity	Lt	30
Dimensão da Cuba / Dim. cuve / Dim. cuba / Vat dim.	Ømm	370x370
Capacidade de massa / Capacité pâte / Capacidad masa / Dough capacity	kg	9,3
Velocidade / Vitesse / Velocidad / Speed	kg	65/157/287
Peso Líquido-Bruto / Poids Net-Brut / Peso Neto-Bruto / Net-Gross Weight	kg	170
Potência / Puissance / Potencia / Power	kW	1,0hp
Tensão / Tension / Tensión / Tension	V	400



MODELO / MODÈLE / MODELO / MODEL		BA40-F
CÓDIGO / CODE / CÓDIGO / CODE		2521.446
<b>Preço / Prix / Precio / Price</b>	€	<b>5.059,00</b>
Dimensões / Dimensions / Dimensiones	mm	750x660x1190
Capacidade da Cuba / Capacité cuve / Capacidad cuba / Vat capacity	Lt	40
Dimensão da Cuba / Dim. cuve / Dim. cuba / Vat dim.	Ømm	390x390
Capacidade de massa / Capacité pâte / Capacidad masa / Dough capacity	kg	14
Velocidade / Vitesse / Velocidad / Speed	kg	65/157/287
Peso Líquido-Bruto / Poids Net-Brut / Peso Neto-Bruto / Net-Gross Weight	kg	170
Potência / Puissance / Potencia / Power	kW	1,5hp
Tensão / Tension / Tensión / Tension	V	400

**BATEDEIRAS | BATTEURS | BATIDORAS | MIXER - MOD SP**
**KIT DE REDUÇÃO / KIT DE RÉDUCTION / KIT DE REDUCCIÓN / REDUCTION KIT**

Cód.	Ref.	€
2521.500	20/40 - P/MOD SP40	2.476,00
2521.505	30/60 - P/MOD SP60	2.860,00
2521.580	10/20 - P/MOD BA20L	1.174,00
2521.582	20/40 - P/MOD BA20L	2.006,00

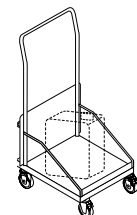
**CARRO PARA BALDE / CHARIOT POUR CUVE / CARRO PARA BALDE / TROLLEY FOR VAT**

Cód.	Ref.	€
2521.510	TROLLY P/40/60	235,00

**BATEDEIRAS | BATTEURS | BATIDORAS | MIXER**
**MOD SP**
**SP 30 / 40 / 60 / 100 / 200**
**PINHA / CABOCHE /  
PIÑA / HEAP**

Cód.	Ref.	€
2521.572	5 L	100,00
2521.515	8 L	128,00
2521.523	10 L	220,00
2521.531	20 L	261,00
2521.539	30 L	384,00
2521.547	34 L	384,00
2521.559	40 L	427,00
2521.555	60 L	534,00

**GANCHO / CROCHET /  
GANCHO / HOOK**

Cód.	Ref.	€
2521.574	5 L	85,00
2521.511	8 L	107,00
2521.519	10 L	171,00
2521.527	20 L	213,00
2521.535	30 L	320,00
2521.543	34 L	320,00
2521.557	40 L	363,00
2521.551	60 L	448,00

**ESPATULA / SPATULE /  
ESPÁTULA / SPATULA**

Cód.	Ref.	€
2521.573	5 L	85,00
2521.513	8 L	107,00
2521.521	10 L	171,00
2521.529	20 L	213,00
2521.537	30 L	320,00
2521.545	34 L	320,00
2521.558	40 L	363,00
2521.553	60 L	448,00

**TINA / CUVE /  
CUBA / VAT**

Cód.	Ref.	€
2521.575	5 L	149,00
2521.509	8 L	192,00
2521.517	10 L	299,00
2521.525	20 L	341,00
2521.533	30 L	662,00
2521.541	34 L	704,00
2521.556	40 L	747,00
2521.549	60 L	854,00

**MOD BA**

Cód.	Ref.	€
2521.560	20 L	320,00
2521.564	30 L	384,00
2521.568	40 L	361,00

Cód.	Ref.	€
2521.561	20 L	256,00
2521.565	30 L	320,00
2521.569	40 L	320,00

Cód.	Ref.	€
2521.562	20 L	256,00
2521.566	30 L	320,00
2521.570	40 L	320,00

Cód.	Ref.	€
2521.563	20 L	341,00
2521.567	30 L	619,00
2521.571	40 L	683,00





UDI



confirmar disponibilidade dos produtos desta página  
confirmer la disponibilité des produits sur cette page  
confirmar la disponibilidad de los productos en esta página  
confirm availability of products on this page

**BATEDEIRAS - OPORTUNIDADES**

MÉLANGEURS - OPPORTUNITÉS

BATIDORES - OPORTUNIDADES

MIXERS - OPPORTUNITIES



Alta qualidade  
Haute qualité  
Alta calidad  
High quality

**pietroberto**



**BATEDEIRA PLANETÁRIA POCKET COM ELEVAÇÃO DA TINA**  
BATTEUR PLANÉTAIRE POCKET AVEC CUVE D'ÉLEVATION  
BATIDORA PLANETARIA POCKET CON ELEVACIÓN DE LA CUBA  
POCKET MIXER WITH VAT ELEVATION

MODELO / MODÈLE / MODELO / MODEL	POCKET 40L	POCKET 60L
CÓDIGO / CODE / CÓDIGO / CODE	2522.058	2522.060
<b>Preço / Prix / Precio / Price</b>	<b>€ 10.169,00</b>	<b>11.324,00</b>
Dimensões / Dimensions / Dimensiones	mm 700x900x1440	800x1000x1500
Capacidade da Cuba /Capacité cuve /Capacidad cuba /Vat capacity	Lt 40	60
Peso Líquido /Poids Net /Peso Neto / Net Weight	kg 246	332
Potência / Puissance / Potencia / Power	kW 1,3	1,3
Tensão / Tension / Tensión / Tension	V 400	400



MODELO / MODÈLE / MODELO / MODEL	MIX 40L
CÓDIGO / CODE / CÓDIGO / CODE	2522.078
<b>Preço / Prix / Precio / Price</b>	<b>€ 10.680,00</b>
Dimensões / Dimensions / Dimensiones	mm 540x910x1450
Capacidade da Cuba /Capacité cuve /Capacidad cuba /Vat capacity	Lt 40
Peso Líquido /Poids Net /Peso Neto / Net Weight	kg 370
Potência / Puissance / Potencia / Power	kW 1,3
Tensão / Tension / Tensión / Tension	V 400

**ACESSÓRIOS E OPCIONAIS**

ACCESSOIRES ET OPTIONNELS

ACCESORIOS Y OPCIONALES

OPTIONALS AND SPARE PARTS



**PINHA / CABOCHÉ / PIÑA / HEAP**

Cód.	Ref.	€
2522.082	20 L	<b>635,00</b>



**GANCHO / CROCHET / GANCHO / HOOK**

Cód.	Ref.	€
2522.090	40 L	<b>544,00</b>
2522.098	60 L	<b>635,00</b>

**KIT REDUÇÃO / KIT RÉDUCTION / KIT REDUCIÓN / REDUCTION KIT**

Cód.	Ref.	€
2522.092	40-20L	<b>1.749,00</b>



**ESPATULA / SPATULE / ESPÁTULA / SPATULA**

Cód.	Ref.	€
2522.085	40-20L	<b>365,00</b>



**TINA / CUVE / CUBA / VAT**

Cód.	Ref.	€
2522.080	20 L	<b>635,00</b>
2522.086	40 L	<b>808,00</b>
2522.094	60 L	<b>611,00</b>



Lamina todo o tipo de massas inclusive as de espessura mais fina. Alimentação elétrica de baixa tensão controlada por mão ou pedal. Raspadores de fácil remoção.



Laminai tout type de pâtes dont l'épaisseur plus mince. L'alimentation de basse tension commandée à la main ou au pied. Grattoirs de facile retrait.



Lamina cualquier tipo de pasta incluyendo el espesor más delgado. Fuente de alimentación de baja tensión controlada con la mano o pedal. Raspadores de fácil remoción.



Laminates any type of pasta including the thinner thickness. The low voltage electric supply can be controlled either by hand or foot pedal. Scrapers can be remove easily.



MODELO / MODÈLE / MODELO / MODEL	UD SFB 500 1V	
CÓDIGO / CODE / CÓDIGO / CODE	2521.902	
<b>Preço / Prix / Precio / Price</b>	<b>€</b>	<b>7.700,00</b>
Dimensões tapete aberto / Dim. tapis ouvert / Dim. cinta transp. aberta / Opened conveyor dimensions	mm	1800x880x650
Dimensões tapete fechado / Dim. tapis fermé / Dim. cinta transp. cerrada / closed conveyor dimensions	mm	450x640x750
Medida do Tapete / Mesure tapis / Medida cinta transp. / Conveyor measure	mm	500x710
Comprimento do Cilindro / Longuer cylindre / longLtud cilindro / Cylinder length	mm	500
Diâmetro do Cilindro / Diamètre du cylindre / Diámetro de los cilindros / Cylinder diameter	mm	60
Abertura dos cilindros / Ouverture des cylindres / Abertura de los cilindros / Openning cylinders	mm	0-35
Peso Líquido-Bruto / Poids Net-Brut / Peso Neto-Bruto / Net-Gross Weight	kg	120
Potência / Puissance / Potencia / Power	Hp	1
Tensão / Tension / Tensión / Tension	V	400



MODELO / MODÈLE / MODELO / MODEL	UD SF 500 2V	
CÓDIGO / CODE / CÓDIGO / CODE	2521.905	
<b>Preço / Prix / Precio / Price</b>	<b>€</b>	<b>9.081,00</b>
Dimensões tapete aberto / Dim. tapis ouvert / Dim. cinta transp. aberta / Opened conveyor dimensions	mm	2320x880x1100
Dimensões tapete fechado / Dim. tapis fermé / Dim. cinta transp. cerrada / closed conveyor dimensions	mm	690x880x1720
Medida do Tapete / Mesure tapis / Medida cinta transp. / Conveyor measure	mm	500x950
Comprimento do Cilindro / Longuer cylindre / longLtud cilindro / Cylinder length	mm	500
Diâmetro do Cilindro / Diamètre du cylindre / Diámetro de los cilindros / Cylinder diameter	mm	60
Abertura dos cilindros / Ouverture des cylindres / Abertura de los cilindros / Openning cylinders	mm	0-35
Peso Líquido-Bruto / Poids Net-Brut / Peso Neto-Bruto / Net-Gross Weight	kg	160
Potência / Puissance / Potencia / Power	Hp	1
Tensão / Tension / Tensión / Tension	V	400



MODELO / MODÈLE / MODELO / MODEL	UD SF 600 2V	
CÓDIGO / CODE / CÓDIGO / CODE	2521.910	
<b>Preço / Prix / Precio / Price</b>	<b>€</b>	<b>10.544,00</b>
Dimensões tapete aberto / Dim. tapis ouvert / Dim. cinta transp. aberta / Opened conveyor dimensions	mm	2780x1010x1160
Dimensões tapete fechado / Dim. tapis fermé / Dim. cinta transp. cerrada / closed conveyor dimensions	mm	900x1010x1960
Medida do Tapete / Mesure tapis / Medida cinta transp. / Conveyor measure	mm	600x1200
Comprimento do Cilindro / Longuer cylindre / longLtud cilindro / Cylinder length	mm	600
Diâmetro do Cilindro / Diamètre du cylindre / Diámetro de los cilindros / Cylinder diameter	mm	70
Abertura dos cilindros / Ouverture des cylindres / Abertura de los cilindros / Openning cylinders	mm	0-35
Peso Líquido-Bruto / Poids Net-Brut / Peso Neto-Bruto / Net-Gross Weight	kg	215
Potência / Puissance / Potencia / Power	Hp	1
Tensão / Tension / Tensión / Tension	V	400

**LAMINADORES | LAMINOIRS | LAMINADORES | SHEETERS - MOD UD**

**SUPORTE C/ RODAS INOX / SUPPORT AVEC RODES / SOPORTE CON RUEDAS / SUPPORT WITH WHEELS**

**0** Cód. Ref. €  
2521.920 P/ MOD. UD SFB 500X1420 **860,00**

**SUPORTE ENVERNIZADO EM FORMA DE Z / SUPPORT VERNIZ EN FORME DE Z / SOPORTE ENBARNIZADO EN FORMA DE Z / VARNISH SUPPORT IN Z SHAPE**

**0** Cód. Ref. €  
2521.922 P/ MOD. UD SFB 500X1420 **630,00**

**0** opcional  
opcional  
opcional  
optional



UDI

## DIVISORAS ENROLADORAS MANUAIS E SEMIAUTOMÁTICAS

DIVISEUSES ENROLEUSES MANUELS ET SEMIAUTOMATIQUES

DIVISORAS ENROLLADORAS MANUALES Y SEMIAUTOMÁTICAS

MANUAL AND SEMIAUTOMATIC ROLLERS DIVIDERS



MODELO / MODÈLE / MODELO / MODEL	DMM 30	
CÓDIGO / CODE / CÓDIGO / CODE	2522.030	
<b>Preço / Prix / Precio / Price</b>	€	<b>6.088,00</b>
Dimensões / Dimensions / Dimensiones	mm	580x520x1360
Peso Êmpelo / Poids Êmpelo / Peso Êmpelo / Êmpelo weight	gr	3600
Peso Máx. / Poids Máx. / Peso Máx. / Max. weight	gr	120
Peso Líquido-Bruto / Poids Net-Brut / Peso Neto-Bruto / Net-Gross Weight	kg	225
Potência / Puissance / Potencia / Power	kW	-
Tensão / Tension / Tensión / Tension	V	400

MODELO / MODÈLE / MODELO / MODEL	DM 30	
CÓDIGO / CODE / CÓDIGO / CODE	2522.032	
<b>Preço / Prix / Precio / Price</b>	€	<b>10.354,00</b>
Dimensões / Dimensions / Dimensiones	mm	580x520x1360
Peso Êmpelo / Poids Êmpelo / Peso Êmpelo / Êmpelo weight	gr	900-2700
Peso Máx. / Poids Máx. / Peso Máx. / Max. weight	gr	30-90
Peso Líquido-Bruto / Poids Net-Brut / Peso Neto-Bruto / Net-Gross Weight	kg	320
Potência / Puissance / Potencia / Power	kW	1,1
Tensão / Tension / Tensión / Tension	V	400

MODELO / MODÈLE / MODELO / MODEL	DM 22	
CÓDIGO / CODE / CÓDIGO / CODE	2522.034	
<b>Preço / Prix / Precio / Price</b>	€	<b>10.354,00</b>
Dimensões / Dimensions / Dimensiones	mm	580x520x1360
Peso Êmpelo / Poids Êmpelo / Peso Êmpelo / Êmpelo weight	gr	1100-3080
Peso Máx. / Poids Máx. / Peso Máx. / Max. weight	gr	50-140
Peso Líquido-Bruto / Poids Net-Brut / Peso Neto-Bruto / Net-Gross Weight	kg	320
Potência / Puissance / Potencia / Power	kW	1,1
Tensão / Tension / Tensión / Tension	V	400

MODELO / MODÈLE / MODELO / MODEL	DM 12	
CÓDIGO / CODE / CÓDIGO / CODE	2522.036	
<b>Preço / Prix / Precio / Price</b>	€	<b>10.354,00</b>
Dimensões / Dimensions / Dimensiones	mm	580x520x1360
Peso Êmpelo / Poids Êmpelo / Peso Êmpelo / Êmpelo weight	gr	1200-3120
Peso Máx. / Poids Máx. / Peso Máx. / Max. weight	gr	120-260
Peso Líquido-Bruto / Poids Net-Brut / Peso Neto-Bruto / Net-Gross Weight	kg	320
Potência / Puissance / Potencia / Power	kW	1,1
Tensão / Tension / Tensión / Tension	V	400





EMME 2C de 2 cilindros de 500mm.  
 EMME 4C de 4 cilindros de 500mm. FB  
 para baguete de 70mm.



EMME 2C de 2 cylindres de 500mm.  
 EMME 4C de 4 cylindres de 500mm. FB  
 pour baguette de 70mm.



EMME 2C de 2 cilindros de 500mm.  
 EMME 4C de 4 cilindros de 500mm. FB  
 para baguete de 70mm.



EMME 2C - 2 cylinders of 500mm.  
 EMME 4C - 24 cylinders of 500mm. FB  
 for 70mm baguette.

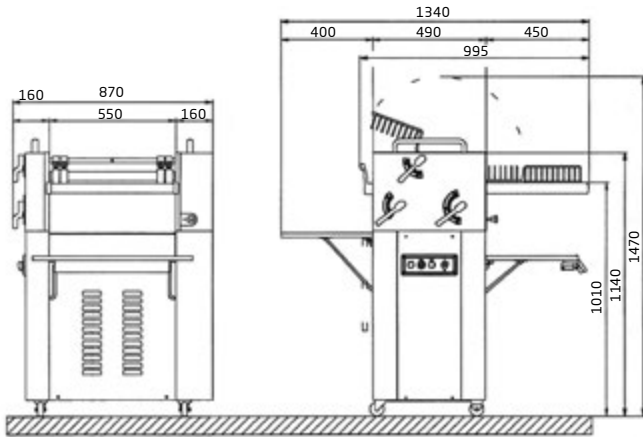

EMME 2C

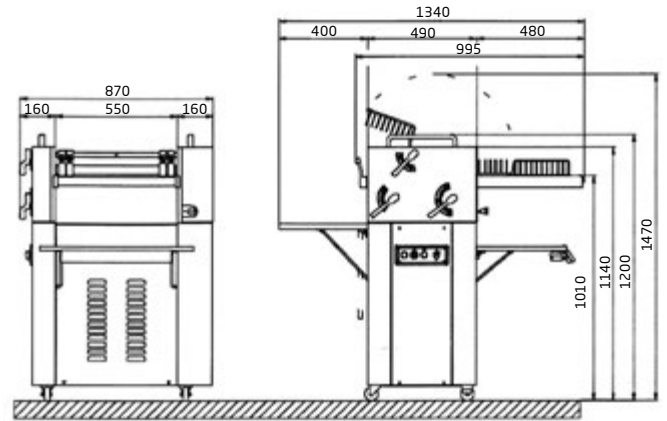

EMME 4C



MODELO / MODÈLE / MODELO / MODEL		FB
CÓDIGO / CODE / CÓDIGO / CODE		2522.044
<b>Preço / Prix / Precio / Price</b>	€	<b>19.244,00</b>
Dimensões / Dimensions / Dimensiones	mm	1050x820x1600
Peso Líquido-Bruto / Poids Net-Brut / Peso Neto-Bruto / Net-Gross Weight	kg	240
Potência / Puissance / Potencia / Power	kW	0,55
Tensão / Tension / Tensión / Tension	V	400



MODELO / MODÈLE / MODELO / MODEL		EMME 2C
CÓDIGO / CODE / CÓDIGO / CODE		2522.040
<b>Preço / Prix / Precio / Price</b>	€	<b>11.814,00</b>
Dimensões / Dimensions / Dimensiones	mm	870x1340x1200
Peso Líquido-Bruto / Poids Net-Brut / Peso Neto-Bruto / Net-Gross Weight	kg	215
Potência / Puissance / Potencia / Power	kW	0,75
Tensão / Tension / Tensión / Tension	V	400



MODELO / MODÈLE / MODELO / MODEL		EMME 4C
CÓDIGO / CODE / CÓDIGO / CODE		2522.042
<b>Preço / Prix / Precio / Price</b>	€	<b>14.153,00</b>
Dimensões / Dimensions / Dimensiones	mm	870x1340x1200
Peso Líquido-Bruto / Poids Net-Brut / Peso Neto-Bruto / Net-Gross Weight	kg	220
Potência / Puissance / Potencia / Power	kW	0,75
Tensão / Tension / Tensión / Tension	V	400



UDI



confirmar disponibilidade  
verifié disponibilité  
confirmar disponibilidad  
confirm availability

## CILINDROS AUTOMÁTICOS E MANUAIS - MOINHOS DE PÃO

CYLINDRES AUTOMATIQUES ET MANUELS - MOULINS DE PAINS

CILINDROS AUTOMÁTICOS Y MANUALES - MOLINOS DE PAN

AUTOMATIC AND MANUAL CYLINDERS - BREAD GRINDERS



CILINDRO MANUAL para massas com rolo de 600mm. MG Grande aço inox .



CYLINDRE MANUEL - Cylindre manuel pour pâte avec rouleau de 600mm. MG Grand acier inoxydable.



CILINDRO MANUAL - Cilindro manual para masa con rolo de 600mm MG Grande acero inoxidable.



MANUAL CYLINDER - Manual cylinder for pasta with roller of 600mm Stainless steel Big MG.

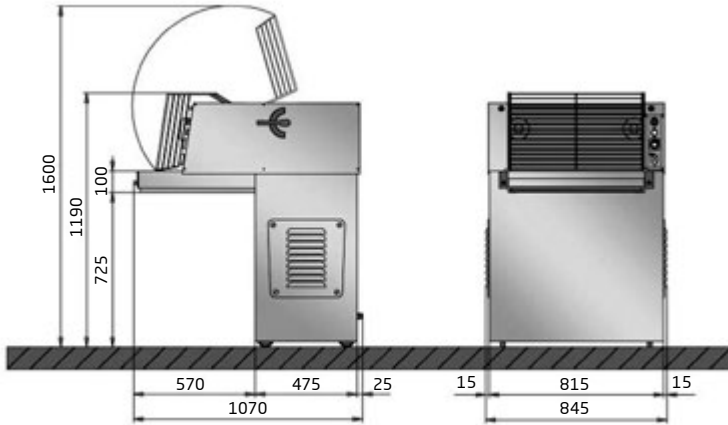

**FILTRO PARA MOINHO**  
FILTRE POUR MOULIN  
FILTRO PARA MOLINO  
GRINDER FILTER

Cód. Ref. €  
2522.056 MG 206,00



MODELO / MODÈLE / MODELO / MODEL	ROLLING 600 AUT. 15 KG	
CÓDIGO / CODE / CÓDIGO / CODE	2522.046	
<b>Preço / Prix / Precio / Price</b>	€	<b>13.970,00</b>
Dimensões / Dimensions / Dimensiones	mm	845x1070x1190
Comprimento do Cilindro / longueur cylindre / longLtud cilindro / Cylinder length	mm	600
Produção / Production / Producción / Production	kg/h	-
Peso Líquido-Bruto / Poids Net-Brut / Peso Neto-Bruto / Net-Gross Weight	kg	320
Potência / Puissance / Potencia / Power	kW	3
Tensão / Tension / Tensión / Tension	V	400



MODELO / MODÈLE / MODELO / MODEL	CILINDRO MANUAL	
CÓDIGO / CODE / CÓDIGO / CODE	2522.048	
<b>Preço / Prix / Precio / Price</b>	€	<b>7.782,00</b>
Dimensões / Dimensions / Dimensiones	mm	940x850x1400
Comprimento do Cilindro / longueur cylindre / longLtud cilindro / Cylinder length	mm	-
Produção / Production / Producción / Production	kg/h	-
Peso Líquido-Bruto / Poids Net-Brut / Peso Neto-Bruto / Net-Gross Weight	kg	250
Potência / Puissance / Potencia / Power	kW	6
Tensão / Tension / Tensión / Tension	V	400



MODELO / MODÈLE / MODELO / MODEL	MG	
CÓDIGO / CODE / CÓDIGO / CODE	2522.052	
<b>Preço / Prix / Precio / Price</b>	€	<b>5.140,00</b>
Dimensões / Dimensions / Dimensiones	mm	480x550x980
Comprimento do Cilindro / longueur cylindre / longLtud cilindro / Cylinder length	mm	-
Produção / Production / Producción / Production	kg/h	200
Peso Líquido-Bruto / Poids Net-Brut / Peso Neto-Bruto / Net-Gross Weight	kg	49
Potência / Puissance / Potencia / Power	kW	1,5
Tensão / Tension / Tensión / Tension	V	400



automático  
automatique  
automático  
automatic



manual  
manuel  
manual  
manual



opcional  
optionnel  
opcional  
optional



Fatiadora de ajuste fácil e preciso de acordo com o tipo de espessura do pão. Zona de trabalho feito em aço inox. corpo reforçado e tampa em aço inox. Capacidade: 500/h Botão: ON/OFF Botão de paragem de emergência



Trancheuse réglage facile et précis selon le type d'épaisseur du pain. Zone de travail en acier inoxydable. corps renforcé et couvercle en acier inoxydable. Capacité: 500 / h Bouton: ON / OFF Bouton d'arrêt d'urgence



Fácil de ajustar fácil y preciso de acuerdo con el tipo de espesor del pan. Zona de trabajo de acero inoxidable. cuerpo reforzado y tapa de acero inoxidable. Capacidad: 500 / h Botón: ON / OFF Botón de parada de emergencia



Slicer easy and precise adjustment according to the type of bread thickness. Work zone made of stainless steel. reinforced body and stainless steel cover. Capacity: 500 / h Button: ON / OFF Emergency stop button

MODELO / MODÈLE / MODELO / MODEL	UDE 01 13 MM	
CÓDIGO / CODE / CÓDIGO / CODE	2522.708	
<b>Preço / Prix / Precio / Price</b>	€	<b>3.119,00</b>
Dimensões / Dimensions / Dimensiones	mm	650x 720x 1100
Espessura do corte / Épaisseur de découpage / Grosor del corte / Cut thickness	mm	13
Capacidade / Capacité / Capacidad / Capacity	pc/h	500
Dim. Pão / Dim. Pain / Dim. Pan / Bread Dim. (L.A / L.H. / A.A. / W.H.)	mm	500x140
Nº Lâminas / Nombre Lames / Número de Cuchillas / Number of Blades	nr	30
Peso Líquido-Bruto / Poids Net-Brut / Peso Neto-Bruto / Net-Gross Weight	kg	130-140
Potência / Puissance / Potencia / Power	kW	0,37
Tensão / Tension / Tensión / Tension	V	230

MODELO / MODÈLE / MODELO / MODEL	UDE 01 16 MM	
CÓDIGO / CODE / CÓDIGO / CODE	2522.710	
<b>Preço / Prix / Precio / Price</b>	€	<b>3.119,00</b>
Dimensões / Dimensions / Dimensiones	mm	650x 720x 1100
Espessura do corte / Épaisseur de découpage / Grosor del corte / Cut thickness	mm	16
Capacidade / Capacité / Capacidad / Capacity	pc/h	500
Dim. Pão / Dim. Pain / Dim. Pan / Bread Dim. (L.A / L.H. / A.A. / W.H.)	mm	500x140
Nº Lâminas / Nombre Lames / Número de Cuchillas / Number of Blades	nr	30
Peso Líquido-Bruto / Poids Net-Brut / Peso Neto-Bruto / Net-Gross Weight	kg	130-140
Potência / Puissance / Potencia / Power	kW	0,37
Tensão / Tension / Tensión / Tension	V	230



MODELO / MODÈLE / MODELO / MODEL	UDE 01 20 MM	
CÓDIGO / CODE / CÓDIGO / CODE	2522.712	
<b>Preço / Prix / Precio / Price</b>	€	<b>3.119,00</b>
Dimensões / Dimensions / Dimensiones	mm	650x 720x 1100
Espessura do corte / Épaisseur de découpage / Grosor del corte / Cut thickness	mm	20
Capacidade / Capacité / Capacidad / Capacity	pc/h	500
Dim. Pão / Dim. Pain / Dim. Pan / Bread Dim. (L.A / L.H. / A.A. / W.H.)	mm	500x140
Nº Lâminas / Nombre Lames / Número de Cuchillas / Number of Blades	nr	30
Peso Líquido-Bruto / Poids Net-Brut / Peso Neto-Bruto / Net-Gross Weight	kg	130-140
Potência / Puissance / Potencia / Power	kW	0,37
Tensão / Tension / Tensión / Tension	V	230

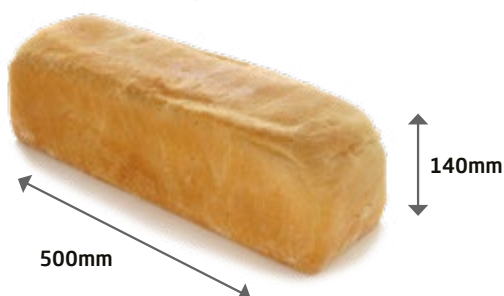

**KIT ALTERAÇÃO MEDIDA EM ALTURA**  
 KIT DE CHANGEMENT DE MESURE DE HAUTEUR  
 KIT DE CAMBIO DE MEDIDA DE ALTURA  
 HEIGHT ADJUSTMENT KIT

Cód. €  
 2522.714 **234,00**





**FORNO**  
 Adaptável para gás natural ou GPL  
 Válvula de segurança magnética  
 Sistema de plataforma modular  
 Ignição eletrónica do queimador  
 Indicador de temperatura digital



**FOUR**  
 Adaptable pour gaz naturel ou gpl  
 Soupape de sûreté magnétique  
 Système de plate-forme modulaire  
 Brûleur d'allumage électronique  
 Indicateur digital de température



**HORNO**  
 Adaptable para gas natural o gpl  
 Válvula de seguridad magnética  
 Sistema de plataforma modular  
 Quemador de encendido electrónico  
 Indicador digital de la temperatura



**OVEN**  
 Adaptable for natural gas or LPG  
 Magnetic safety valve  
 Modular platform system  
 Electronic burner ignition  
 Digital temperature indicator

**SIMPLES**

MODELO / MODÈLE / MODELO / MODEL		UDFPG4 4 SIMPLES	UDFPG6 6 SIMPLES	UDFPG9 9 SIMPLES
CÓDIGO / CODE / CÓDIGO / CODE		5200.060	5200.064	5200.068
<b>Preço / Prix / Precio / Price</b>	<b>€</b>	<b>3.623,00</b>	<b>4.110,00</b>	<b>4.943,00</b>
Dimensões / Dimensions / Dimensiones	mm (LPA)	1100x 950x 520	1400x 950x 520	1400x 1250x 520
Dimensão Interior / Dimensions intérieures / Dimensiones interiores / Interior Dimensions	mm (LPA)	615x615 x 150	915x615 x 150	915 x 915 x 150
Capacidade / Capacite / Capacidad / Capacity		Ø 300 mm x 4 Pizzas	Ø 300 mm x 6 Pizzas	Ø 300 mm x 9 Pizzas
Peso / Poids / Peso / Weight	kg	125	161	200
Volume / Volume / Volumen / Volume	m3	0.54	0.69	0.91
Power / Puissance / Potência / Power	kW	5	7,5	10
Tensão / Tension / Tension / Tension	V	230	230	230

**DUPLO**

MODELO / MODÈLE / MODELO / MODEL		UDFPG8 4+4 DUPLO	UDFPG12 6+6 DUPLO	UDFPG18 9+9 DUPLO
CÓDIGO / CODE / CÓDIGO / CODE		5200.062	5200.066	5200.070
<b>Preço / Prix / Precio / Price</b>	<b>€</b>	<b>6.906,00</b>	<b>8.217,00</b>	<b>8.774,00</b>
Dimensões / Dimensions / Dimensiones	mm (LPA)	1100x 950x 1040	1400 x 950x 1040	1400x 1250x 1040
Dimensão Interior / Dimensions intérieures / Dimensiones interiores / Interior Dimensions	mm (LPA)	615x615 x 150	915x615 x 150	915 x 915 x 150
Capacidade / Capacite / Capacidad / Capacity		Ø 300 mm x 4+4 Pizzas	Ø 300 mm x 6+6 Pizzas	Ø 300 mm x 9+9 Pizzas
Peso / Poids / Peso / Weight	kg	250	322	400
Volume / Volume / Volumen / Volume	m3	1.08	1.38	1.82
Power / Puissance / Potência / Power	kW	10	15	20
Tensão / Tension / Tension / Tension	V	230	230	230





UDI

**FORNOS DE PIZZA - GÁS**  
FOURS À PIZZA - GAZ  
HORNOS PARA PIZZA - GAS  
OVENS FOR PIZZA - GAS



SUPORTE  
Sem rodas, com prateleira intermédia



SUPORTE  
Sans roues, avec étagère intermédiaire



SOPORTE  
Sin ruedas, con estante intermedio



STAND  
Without wheels, with intermediate shelf



MODELO / MODÈLE / MODELO / MODEL		SUPORTE FORNO UDFPG4 / 4+4	SUPORTE FORNO UDFPG9 / 9+9
CÓDIGO / CODE / CÓDIGO / CODE		5200.080	5200.084
<b>Preço / Prix / Precio / Price</b>	<b>€</b>	<b>757,00</b>	<b>1.135,00</b>
Dimensões / Dimensions / Dimensiones	mm (LPA)	910x 865x 850	1210x 1165x 850
Peso / Poids / Peso / Weight	kg	22	36
Volume / Volume / Volumen / Volume	m <sup>3</sup>	0,67	1,2



opcional  
optionnel  
opcional  
optional



Modelo S em aço inox com possibilidade de sobrepôr, no máximo, dois módulos do mesmo modelo. Sistema de Controlo electrónico de chama com interruptor de rearme. Substituição da lâmpada pelo interior.



Modèle S en acier inoxydable avec possibilité de superposer au maximum deux modules du même modèle. Système de contrôle électronique de la flamme avec interrupteur de remettre. Substitution de la lampe par l'intérieur.



Modelo S en acero inoxidable con posibilidad de sobreponer, un máximo de dos módulos del mismo modelo. Sistema de control electrónico de la llama con interruptor de reajustamiento. Substitución de la bombilla desde el interior.



S models in stainless steel with the possibility of stacking a maximum of two modules of the same model. Electronic system flame control with reset. Substitution of the lamp from inside.



MODELO / MODÈLE / MODELO / MODEL	G4 - 33 S	
CÓDIGO / CODE / CÓDIGO / CODE	2110.140	
<b>Preço / Prix / Precio / Price</b>	<b>€</b>	<b>5.727,00</b>
Dimensões / Dimensions / Dimensiones	mm	1070x980x500
Largura da Câmara / largeur de la chambre / Ancho de la cámara / Chamber Width	mm	660
Profundidade da Câmara / Profondeur de la chambre / Profundidad de la cámara / Chamber Depth	mm	660
Altura da Câmara / Hauteur de la chambre / Altura de la cámara / Chamber Height	mm	145
Nº Pizzas / N° Pizzas / N° Pizzas / Pizzas No.	nr (mm)	4 (Ø330) 1 (Ø450)
Peso Líquido-Bruto / Poids Net-Brut / Peso Neto-Bruto / Net-Gross Weight	kg	155-172
Potência / Puissance / Potencia / Power	kW	0,03
Tensão / Tension / Tensión / Tension	V	230

270 mm  
540 mm

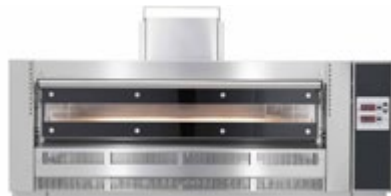

MODELO / MODÈLE / MODELO / MODEL	G4 - 35 S	
CÓDIGO / CODE / CÓDIGO / CODE	2110.141	
<b>Preço / Prix / Precio / Price</b>	<b>€</b>	<b>6.534,00</b>
Dimensões / Dimensions / Dimensiones	mm	1230x1120x540
Largura da Câmara / largeur de la chambre / Ancho de la cámara / Chamber Width	mm	720
Profundidade da Câmara / Profondeur de la chambre / Profundidad de la cámara / Chamber Depth	mm	720
Altura da Câmara / Hauteur de la chambre / Altura de la cámara / Chamber Height	mm	185
Nº Pizzas / N° Pizzas / N° Pizzas / Pizzas No.	nr (mm)	4 (350) 1 (500)
Peso Líquido-Bruto / Poids Net-Brut / Peso Neto-Bruto / Net-Gross Weight	kg	176-204
Potência / Puissance / Potencia / Power	kW	0,15
Tensão / Tension / Tensión / Tension	V	230

270 mm  
540 mm

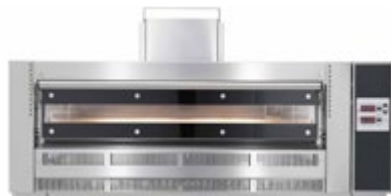

MODELO / MODÈLE / MODELO / MODEL	G6 - 35 S	
CÓDIGO / CODE / CÓDIGO / CODE	2110.143	
<b>Preço / Prix / Precio / Price</b>	<b>€</b>	<b>7.429,00</b>
Dimensões / Dimensions / Dimensiones	mm	1230x1480x540
Largura da Câmara / largeur de la chambre / Ancho de la cámara / Chamber Width	mm	720
Profundidade da Câmara / Profondeur de la chambre / Profundidad de la cámara / Chamber Depth	mm	1080
Altura da Câmara / Hauteur de la chambre / Altura de la cámara / Chamber Height	mm	185
Nº Pizzas / N° Pizzas / N° Pizzas / Pizzas No.	nr (mm)	6 (350) 2 (500)
Peso Líquido-Bruto / Poids Net-Brut / Peso Neto-Bruto / Net-Gross Weight	kg	219-254
Potência / Puissance / Potencia / Power	kW	0,15
Tensão / Tension / Tensión / Tension	V	230

270 mm  
540 mm

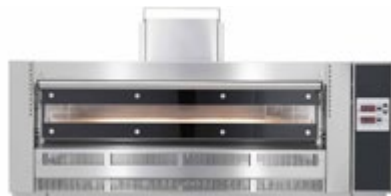

MODELO / MODÈLE / MODELO / MODEL	G9 - 35 S	
CÓDIGO / CODE / CÓDIGO / CODE	2110.144	
<b>Preço / Prix / Precio / Price</b>	<b>€</b>	<b>8.730,00</b>
Dimensões / Dimensions / Dimensiones	mm	1590x1480x540
Largura da Câmara / largeur de la chambre / Ancho de la cámara / Chamber Width	mm	1080
Profundidade da Câmara / Profondeur de la chambre / Profundidad de la cámara / Chamber Depth	mm	1080
Altura da Câmara / Hauteur de la chambre / Altura de la cámara / Chamber Height	mm	185
Nº Pizzas / N° Pizzas / N° Pizzas / Pizzas No.	nr (mm)	9 (350) 4 (500)
Peso Líquido-Bruto / Poids Net-Brut / Peso Neto-Bruto / Net-Gross Weight	kg	271-311
Potência / Puissance / Potencia / Power	kW	0,15
Tensão / Tension / Tensión / Tension	V	230



**SUPORTE / SUPPORT / SOPORTE / SUPPORT**



Cód.	Ref.	Peso	Dimens. (mm)	€	Cód.	Ref.	Peso	Dimens. (mm)	€
2110.152	SG4 / 33 S	33 kg	1060x750x1000	899,00	2110.151	SG4 / 35 S	54 kg	1060x750x1000	1.178,00
2110.155	SG6A / 33 S	38 kg	1060x1080x1000	990,00	2110.153	SG6 / 35 S	65 kg	1060x1080x1000	1.298,00
2110.029	SG8 / 33 S	29 Kg	1060x750x700	780,00	2110.154	SG9 / 35 S	76 Kg	1060x750x700	1.435,00
2110.032	SG12 / 33 S	34 Kg	1060x1080x700	824,00					



opcional  
optionnel  
opcional  
optional



confirmar disponibilidade  
confirmer la disponibilité  
confirmar la disponibilidad  
confirm the availability



UDI

**FORNOS DE PIZZA - ELÉTRICOS**  
FOURS À PIZZA - ÉLECTRIQUES  
HORNOS PARA PIZZA - ELÉCTRICOS  
OVENS FOR PIZZA - ELECTRIC



Sem termómetro  
Sans thermomètre  
Sin termómetro  
Without thermometer



MODELO / MODÈLE / MODELO / MODEL	UD 501
CÓDIGO / CODE / CÓDIGO / CODE	2522.805
<b>Preço / Prix / Precio / Price</b>	€ <b>1.342,00</b>
Dimensões / Dimensions / Dimensiones	mm 760x720x360
Largura da Câmara / Largeur de la chambre / Ancho de la cámara / Chamber Width	mm 500
Profundidade da Câmara / Profondeur de la chambre / Profundidad de la cámara / Chamber Depth	mm 500
Altura da Câmara / Hauteur de la chambre / Altura de la cámara / Chamber Height	mm 100
Nº Pizzas / Nº Pizzas / Nº Pizzas / Pizzas No.	nr(mm) 4 (Ø250)
Peso Líquido-Bruto / Poids Net-Brut / Peso Neto-Bruto / Net-Gross Weight	kg 56/58
Potência / Puissance / Potencia / Power	kW 4
Tensão / Tension / Tensión / Tension	V 400

Sem termómetro  
Sans thermomètre  
Sin termómetro  
Without thermometer

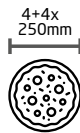

MODELO / MODÈLE / MODELO / MODEL	UD 502
CÓDIGO / CODE / CÓDIGO / CODE	2522.810
<b>Preço / Prix / Precio / Price</b>	€ <b>1.893,00</b>
Dimensões / Dimensions / Dimensiones	mm 760x720x500
Largura da Câmara / Largeur de la chambre / Ancho de la cámara / Chamber Width	mm 500
Profundidade da Câmara / Profondeur de la chambre / Profundidad de la cámara / Chamber Depth	mm 500
Altura da Câmara / Hauteur de la chambre / Altura de la cámara / Chamber Height	mm 100
Nº Pizzas / Nº Pizzas / Nº Pizzas / Pizzas No.	nr(mm) 4+4 (Ø250)
Peso Líquido-Bruto / Poids Net-Brut / Peso Neto-Bruto / Net-Gross Weight	kg 73-83
Potência / Puissance / Potencia / Power	kW 6
Tensão / Tension / Tensión / Tension	V 400

Com termómetro  
Avec thermomètre  
Con termómetro  
With thermometer

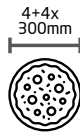

MODELO / MODÈLE / MODELO / MODEL	UD 552
CÓDIGO / CODE / CÓDIGO / CODE	2522.814
<b>Preço / Prix / Precio / Price</b>	€ <b>2.689,00</b>
Dimensões / Dimensions / Dimensiones	mm 870x820x780
Largura da Câmara / Largeur de la chambre / Ancho de la cámara / Chamber Width	mm 620
Profundidade da Câmara / Profondeur de la chambre / Profundidad de la cámara / Chamber Depth	mm 620
Altura da Câmara / Hauteur de la chambre / Altura de la cámara / Chamber Height	mm 150
Nº Pizzas / Nº Pizzas / Nº Pizzas / Pizzas No.	nr(mm) 4+4 (Ø300)
Peso Líquido-Bruto / Poids Net-Brut / Peso Neto-Bruto / Net-Gross Weight	kg 144-154
Potência / Puissance / Potencia / Power	kW 10
Tensão / Tension / Tensión / Tension	V 400

Com termómetro  
Avec thermomètre  
Con termómetro  
With thermometer

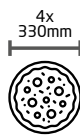

MODELO / MODÈLE / MODELO / MODEL	UD 601
CÓDIGO / CODE / CÓDIGO / CODE	2522.815
<b>Preço / Prix / Precio / Price</b>	€ <b>1.854,00</b>
Dimensões / Dimensions / Dimensiones	mm 930x840x430
Largura da Câmara / Largeur de la chambre / Ancho de la cámara / Chamber Width	mm 680
Profundidade da Câmara / Profondeur de la chambre / Profundidad de la cámara / Chamber Depth	mm 680
Altura da Câmara / Hauteur de la chambre / Altura de la cámara / Chamber Height	mm 150
Nº Pizzas / Nº Pizzas / Nº Pizzas / Pizzas No.	nr(mm) 4 (Ø330)
Peso Líquido-Bruto / Poids Net-Brut / Peso Neto-Bruto / Net-Gross Weight	kg 85-95
Potência / Puissance / Potencia / Power	kW 5,5
Tensão / Tension / Tensión / Tension	V 400

Com termómetro  
Avec thermomètre  
Con termómetro  
With thermometer

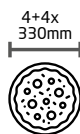

MODELO / MODÈLE / MODELO / MODEL	UD 602
CÓDIGO / CODE / CÓDIGO / CODE	2522.820
<b>Preço / Prix / Precio / Price</b>	€ <b>3.133,00</b>
Dimensões / Dimensions / Dimensiones	mm 930x840x780
Largura da Câmara / Largeur de la chambre / Ancho de la cámara / Chamber Width	mm 680
Profundidade da Câmara / Profondeur de la chambre / Profundidad de la cámara / Chamber Depth	mm 680
Altura da Câmara / Hauteur de la chambre / Altura de la cámara / Chamber Height	mm 150
Nº Pizzas / Nº Pizzas / Nº Pizzas / Pizzas No.	nr(mm) 4+4 (Ø330)
Peso Líquido-Bruto / Poids Net-Brut / Peso Neto-Bruto / Net-Gross Weight	kg 155-165
Potência / Puissance / Potencia / Power	kW 11
Tensão / Tension / Tensión / Tension	V 400

**TIZIANO**

Câmara de cozedura em chapa de alumínio com iluminação.  
Resistências individuais com potências diferenciadas (superior e inferior).  
Frente em aço inox.  
Controlo independente da temperatura da câmara e da placa.  
Termómetro da temperatura da câmara.  
Termostato de segurança.  
Temperatura máxima de funcionamento de 400 °C.  
Comando eletromecânico.  
Placa refratária de cordierita



Chambre de cuisson en tôle d'aluminium avec éclairage.  
Puissances différenciées sur le toit et le sol.  
Partie frontale en acier inoxydable.  
Contrôle indépendant de la température de la chambre de cuisson et base.  
Pyromètre d'affichage de la température de la chambre.  
Thermostat de sécurité.  
Température maximale de fonctionnement 400 °C.  
Comande Electromécanique.  
Sol réfractaire Cordierite



Câmara de cocção em chapa aluminizada com lâmpara de iluminação.  
Resistências com potencia diferenciado (bóveda - solera).  
Frente de acero inoxidable.  
Control independiente de temperatura tanto de la cámara y de la solera.  
Pirómetro de la temperatura de la cámara.  
Termostato de seguridad.  
Máxima temperatura de funcionamiento 400 °C.  
Comando Electromecánico.  
Superficie de cocción realizada con ladrillos de cordierita



Chamber of cooking in aluminum plate with lighting.  
Resistances with differentiated power on the roof and ground.  
Stainless steel front.  
Control independent of temperature of both camera and sill.  
Chamber pyrometer temperature control.  
Safety thermostat.  
Maximum operating temperature 400 °C.  
Electromechanical Command.  
Cordierite refractory floor

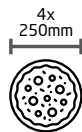

MODELO / MODÈLE / MODELO / MODEL	TZ425/1M
CÓDIGO / CODE / CÓDIGO / CODE	2110.794
<b>Preço / Prix / Precio / Price</b>	€ <b>1.649,00</b>
Dimensões / Dimensions / Dimensiones	mm 802x664x385
Dim. Câmara / Dim. chambre / Dim. cámara / Chamber Dim.	mm 520x520x160
Nº Pizzas / Nº Pizzas / Nº Pizzas / Pizzas No.	nr(mm) 4 (Ø250)
Consumo hora / Heure consommation / Consumo hora / Hourconsumption	kW/h 2,4
Peso Líquido-Bruto / Poids Net-Brut / Peso Neto-Bruto / Net-Gross Weight	kg 60-75
Potência / Puissance / Potencia / Power	kW 4
Tensão / Tension / Tensión / Tension	V 400

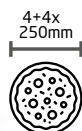

MODELO / MODÈLE / MODELO / MODEL	TZ425/2M
CÓDIGO / CODE / CÓDIGO / CODE	2110.802
<b>Preço / Prix / Precio / Price</b>	€ <b>2.958,00</b>
Dimensões / Dimensions / Dimensiones	mm 802x664x700
Dim. Câmara / Dim. chambre / Dim. cámara / Chamber Dim.	mm 520x520x160
Nº Pizzas / Nº Pizzas / Nº Pizzas / Pizzas No.	nr(mm) 4+4 (Ø250)
Consumo hora / Heure consommation / Consumo hora / Hourconsumption	kW/h 4,8
Peso Líquido-Bruto / Poids Net-Brut / Peso Neto-Bruto / Net-Gross Weight	kg 101-117
Potência / Puissance / Potencia / Power	kW 8
Tensão / Tension / Tensión / Tension	V 400

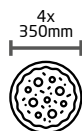

MODELO / MODÈLE / MODELO / MODEL	TZ435/1M
CÓDIGO / CODE / CÓDIGO / CODE	2110.798
<b>Preço / Prix / Precio / Price</b>	€ <b>2.035,00</b>
Dimensões / Dimensions / Dimensiones	mm 1002x864x385
Dim. Câmara / Dim. chambre / Dim. cámara / Chamber Dim.	mm 720x720x160
Nº Pizzas / Nº Pizzas / Nº Pizzas / Pizzas No.	nr(mm) 4 (Ø350)
Consumo hora / Heure consommation / Consumo hora / Hourconsumption	kW/h 3,2
Peso Líquido-Bruto / Poids Net-Brut / Peso Neto-Bruto / Net-Gross Weight	kg 95-116
Potência / Puissance / Potencia / Power	kW 5,2
Tensão / Tension / Tensión / Tension	V 400



MODELO / MODÈLE / MODELO / MODEL	TZ435/2M
CÓDIGO / CODE / CÓDIGO / CODE	2110.804
<b>Preço / Prix / Precio / Price</b>	€ <b>3.743,00</b>
Dimensões / Dimensions / Dimensiones	mm 1002x864x700
Dim. Câmara / Dim. chambre / Dim. cámara / Chamber Dim.	mm 720x720x160
Nº Pizzas / Nº Pizzas / Nº Pizzas / Pizzas No.	nr(mm) 4+4 (Ø350)
Consumo hora / Heure consommation / Consumo hora / Hourconsumption	kW/h 6,4
Peso Líquido-Bruto / Poids Net-Brut / Peso Neto-Bruto / Net-Gross Weight	kg 158-180
Potência / Puissance / Potencia / Power	kW 10,4
Tensão / Tension / Tensión / Tension	V 400

**HOTTE / HOTTE / HOTTE / HOTTE**

Cód.	Ref.	Dimens.	Peso	€
2110.810	KTZ 425	805x815x150	16,5 kg	<b>522,00</b>
	KTZ 435	1005x1015x150	18,5 kg	<b>687,00</b>



opcional  
optionnel  
opcional  
optional

**SUPORTE / SUPPORT / SOPORTE / SUPPORT**

Cód.	Ref.	Dimens.	Peso	€
2110.806	STZ425/1P	802x642x1170	39,4 kg	<b>657,00</b>
2110.807	STZ425/2P	802x642x970	32,5 kg	<b>657,00</b>
2110.808	STZ435/1P	1002x842x1170	48,4 kg	<b>767,00</b>
2110.809	STZ435/2P	1002x842x970	44,5 kg	<b>767,00</b>





UDI

**FORNOS DE PIZZA - ELÉTRICOS**  
FOURS À PIZZA - ÉLECTRIQUES  
HORNOS PARA PIZZA - ELÉTRICOS  
OVENS FOR PIZZA - ELECTRIC



## TIEPOLO



Fornos elétricos com Controlo digital e analógico.  
Sistema de recuperação de calor integrado na câmara de cozedura.  
Placa refratária de cordierita.  
**TIEPOLO** - Controlo analógico para estabelecer a temperatura da câmara e a potência do grupo de resistências (sup./inf.) de forma diferenciada para mínimo e máximo. Termómetro de Controlo da temperatura da câmara.



Four électriques avec contrôle digital et analogique.  
Système de récupération de chaleur intégré dans le chambre de cuisson.  
Plaque réfractaire cordierite.  
**TIEPOLO** - Contrôle analogique pour établir la température de la chambre et la puissance du groupe de résistances (sup./Inf.) différemment pour minimale et maximale. Thermomètre de contrôle de la température de la chambre.



Hornos eléctricos con control digital y analógico.  
Sistema de recuperación de calor integrado en la cámara de cocción.  
Placa refractaria Cordierita.  
**TIEPOLO** - Control analógico para establecer la temperatura de la cámara y la potencia del grupo de resistencias (sup./Inf.) de modo distinto para mínimo y máximo. Termómetro para controlar la temperatura de la cámara.



Electric ovens with digital and analogue control.  
Heat recovery system integrated in the cooking chamber.  
Refractory bricks in cordierite.  
**TIEPOLO** - Analog control to establish the temperature of the chamber and the power of the group of heating elements (sup./Inf.) in a differentiated manner at minimum and maximum. Chamber pyrometer temperature control.



TP 435 | 635 | 935

### HOTTE / HOTTE / HOTTE / HOTTE

Cód.	Ref.	Vol.	Dimens. (mm)	V. / Pot.	€
2110.736	KTP435AS	700 m³/h	1020x1164x362	230/0,13	<b>2.611,00</b>
2110.738	KTP635AS	700 m³/h	1020x1524x362	230/0,13	<b>2.669,00</b>
2110.739	KTP635LAS	700 m³/h	1380x1164x362	230/0,13	<b>2.955,00</b>
2110.740	KTP935AS	700 m³/h	1380x1524x362	230/0,13	<b>3.013,00</b>

### SUPORTE / SUPPORT / SOPORTE / SUPPORT

Cód.	Ref.	Dimens. (mm)	€
2110.730	STP 435 / 1S H 1100 mm	1020x860x1100	<b>1.098,00</b>
2110.732	STP635 / 1S H 1100 mm	1020x1220x1100	<b>1.209,00</b>
2110.733	STP635L / 1S H 1100 mm	1380x860x1100	<b>1.231,00</b>
2110.734	STP935/1S H 1100 mm	1380x1220x1100	<b>1.345,00</b>
2110.735	STP935/2 P/ TP935/2	1380x1220x900	<b>1.345,00</b>
2110.742	STP 435 / 2P H 900 mm	1020x860x900	<b>1.098,00</b>
2110.744	STP635 / 2S H 900 mm	1020x1220x900	<b>1.209,00</b>
2110.746	STP635L/2S H 900mm	1380x860x900	<b>1.231,00</b>

As rodas são opcionais (sob consulta)  
Les roues sont optionnelles (sur demande)  
Las ruedas son opcionales (bajo consulta)  
Wheels are optional (on request)



MODELO / MODÈLE / MODELO / MODEL	TP 435/1 4P	TP 635/1 6P	TP 635L/1 6P	TP 935/1 9P
CÓDIGO / CODE / CÓDIGO / CODE	2110.702	2110.704	2110.705	2110.706
<b>Preço / Prix / Precio / Price</b>	<b>€ 2.756,00</b>	<b>3.853,00</b>	<b>4.207,00</b>	<b>4.977,00</b>
Dimensões / Dimensions / Dimensiones	mm 1020x 920x 406	1020x 1280x 406	1380x 920x 406	1380x 1280x 406
Dim. Câmara / Dim. chambre / Dim. cámara / Chamber Dim.	mm 720x720x145	720x1080x145	1080x720x145	1080x1080x145
Nº Pizzas / Nº Pizzas / Nº Pizzas / Pizzas No.	nr(mm) 4 (Ø350)	6 (Ø350)	6 (Ø350)	9 (Ø350)
Peso Líquido-Bruto / Poids Net-Brut / Peso Neto-Bruto / Net-Gross Weight	kg 106	133	145	171
Potência / Puissance / Potencia / Power	kW 5,3	7,8	7,9	11,7
Tensão / Tension / Tensión / Tension	V 400	400	400	400

MODELO / MODÈLE / MODELO / MODEL	TP 435/2 4+4P	TP 635/2 6+6P	TP 635L/2 6+6P	TP 935/2 9+9P
CÓDIGO / CODE / CÓDIGO / CODE	2110.708	2110.710	2110.711	2110.714
<b>Preço / Prix / Precio / Price</b>	<b>€ 4.812,00</b>	<b>6.414,00</b>	<b>7.186,00</b>	<b>8.823,00</b>
Dimensões / Dimensions / Dimensiones	mm 1020x 920x 732	1020x 1280x 732	1380x 920x 732	1380x 1280x 732
Dim. Câmara / Dim. chambre / Dim. cámara / Chamber Dim.	720x720x720	720x1080x145	1080x720x145	1080x1080x145
Nº Pizzas / Nº Pizzas / Nº Pizzas / Pizzas No.	nr(mm) 4+4 (Ø350)	6+6 (Ø350)	6+6 (Ø350)	9+9 (Ø350)
Peso Líquido-Bruto / Poids Net-Brut / Peso Neto-Bruto / Net-Gross Weight	kg 171	231	247	301
Potência / Puissance / Potencia / Power	kW 10,6	15,6	15,8	23,4
Tensão / Tension / Tensión / Tension	V 400	400	400	400



opcional  
optionnel  
opcional  
optional

## DONATELLO PAINEL D



Fornos elétricos com Controlo digital e analógico. Sistema de recuperação de calor integrado na câmara de cozedura. Placa refratária de cordierita.

**DONATELLO** - Controlo digital para estabelecer a temperatura da câmara e a potência do grupo de resistências (sup./inf.) de forma diferenciada para mínimo e máximo. Painel de Controlo separado.



Four électriques avec contrôle digital et analogique. Système de récupération de chaleur intégré dans le chambre de cuisson. Plaque réfractaire cordierite.

**DONATELLO** - Contrôle digital pour établir la température de la chambre et la puissance du groupe de résistances (sup./Inf.) différemment pour minimale et maximale. Panneau de contrôle séparé



Hornos eléctricos con control digital y analógico. Sistema de recuperación de calor integrado en la cámara de cocción. Placa refractaria Cordierita.

**DONATELLO** - Control digital para establecer la temperatura de la cámara y la potencia del grupo de resistencias (sup./Inf.) de modo distinto para mínimo y máximo. Pantalla de control separada.



Electric ovens with digital and analogue control. Heat recovery system integrated in the cooking chamber. Refractory bricks in cordierite.

**DONATELLO** - Digital control to establish the temperature of the chamber and the power of the group of heating elements (Sup./Inf.) in a differentiated manner at minimum and maximum. Separated control panel.



DN 435 | 635 | 935

### HOTTE / HOTTE / HOTTE / HOTTE

Cód.	Ref.	Vol.	Dimens. (mm)	V. / Pot.	€
2110.788	KDN435AS	700 m³/h	1155x760x630	230/0,13	<b>2.763,00</b>
2110.790	KDN635AS	700 m³/h	1155x1120x630	230/0,13	<b>2.822,00</b>
2110.791	KDN635LAS	700 m³/h	1515x870x630	230/0,13	<b>3.108,00</b>
2110.792	KDN935AS	700 m³/h	1515x760x630	230/0,13	<b>3.168,00</b>

Aspiração com 5 velocidades | Aspiration avec 5 vitesses | Aspiración con 5 velocidades | Aspiration with 5 speeds

### SUPORTE / SUPPORT / SOPORTE / SUPPORT

Cód.	Ref.	Dimens. (mm)	€
2110.782	SDN 435 / 1100mm	1145x725x1100	<b>1.188,00</b>
2110.783	SDN 435 / 900mm	1145x725x900	<b>1.188,00</b>
2110.784	SDN635/1 H1100 mm	1145x1085x1100	<b>1.308,00</b>
2110.787	SDN635/2 H900 mm	1145x1085x900	<b>1.308,00</b>
2110.785	SDN635L/1 H1100 mm	1505x725x1100	<b>1.331,00</b>
2110.787A	SDN635L/2 H900 mm	1505x725x900	<b>1.331,00</b>
2110.786	SDNF935/1 H1100 mm	1505x1085x1100	<b>1.451,00</b>
2110.786A	SDNF935/2 H900 mm	1505x1085x900	<b>1.451,00</b>

As rodas são opcionais (sob consulta)  
Les roues sont optionnelles (sur demande)  
Las ruedas son opcionales (bajo consulta)  
Wheels are optional (On request)



MODELO / MODÈLE / MODELO / MODEL		DN 435/1 4P	DN 635/1 6P	DN 635L/1 6P	DN 935/1 9P
CÓDIGO / CODE / CÓDIGO / CODE		2110.750	2110.752	2110.753	2110.754
Preço / Prix / Precio / Price	€	<b>4.617,00</b>	<b>5.984,00</b>	<b>6.427,00</b>	<b>7.466,00</b>
Dimensões / Dimensions / Dimensiones	mm	1155x1050x437	1155x1410x437	1515x1050x437	1515x1410x437
Dimensões da Câmara / Dimensions chambre / Dimensiones cámara / Chamber Dimensions	mm	720x720x150	720x1080x150	1080x720x150	1080x1080x150
Nº Pizzas / Nº Pizzas / Nº Pizzas / Pizzas No.	nr(mm)	4 (Ø350)	6 (Ø350)	6 (Ø350)	9 (Ø350)
Potência / Puissance / Potencia / Power	kW	5,3	7,8	7,9	11,7
Peso Líquido / Poids Ne t / Peso Neto / Net Weight	kg	106	133	145	171
Tensão / Tension / Tensión / Tension	V	400	400	400	400

MODELO / MODÈLE / MODELO / MODEL		DN 435/2 4+4P	DN 635/2 6+6P	DN 635L/2 6+6P	DN 935/2 9+9P
CÓDIGO / CODE / CÓDIGO / CODE		2110.756	2110.758	2110.759	2110.760
Preço / Prix / Precio / Price	€	<b>8.329,00</b>	<b>10.394,00</b>	<b>11.289,00</b>	<b>13.452,00</b>
Dimensões / Dimensions / Dimensiones	mm	1155x1050x784	1155x1410x784	1515x1050x784	1515x1410x784
Dimensões da Câmara / Dimensions chambre / Dimensiones cámara / Chamber Dimensions	mm	720	720	1080	1080
Nº Pizzas / Nº Pizzas / Nº Pizzas / Pizzas No.	nr(mm)	4+4 (Ø350)	6+6 (Ø350)	6+6 (Ø350)	9+9 (Ø350)
Potência / Puissance / Potencia / Power	kW	10,6	15,6	15,8	23,4
Peso Líquido / Poids Ne t / Peso Neto / Net Weight	kg	171	231	247	301
Tensão / Tension / Tensión / Tension	V	400	400	400	400



opcional  
optionnel  
opcional  
optional



UDI

**FORNOS DE PIZZA - ELÉTRICOS**  
FOURS À PIZZA - ÉLECTRIQUES  
HORNOS PARA PIZZA - ELÉTRICOS  
OVENS FOR PIZZA - ELECTRIC



## MICHELANGELO



### HOTTE / HOTTE / HOTTE / HOTTE

Cód.	Ref.	Dimens.	Peso	Pot.	€
2110.293	KMX635L	1500x1335x360	-	-	<b>2.669,00</b>
2110.294	KMX635LAS	1500x1335x360	47kg	0,12kW	<b>3.243,00</b>

### SUPORTE / SUPPORT / SOPORTE / SUPPORT

Cód.	Ref.	Dimens.	Peso	€
2110.268	SMX 635L / 1S	1490x770x1100	50 kg	<b>1.384,00</b>
2110.270	SMX635L / 2S	1490x770x900	46 kg	<b>1.384,00</b>

As rodas são opcionais (sob consulta)  
Les roues sont optionnelles (sur demande)  
Las ruedas son opcionales (bajo consulta)  
Wheels are optional (On request)

MODELO / MODÈLE / MODELO / MODEL		ML635L/1Ø	ML635L/2Ø
CÓDIGO / CODE / CÓDIGO / CODE		2110.248	2110.250
<b>Preço / Prix / Precio / Price</b>	<b>€</b>	<b>7.593,00</b>	<b>12.862,00</b>
Dimensões / Dimensions / Dimensiones	mm	1550x1100x440	1550x1100x780
Dimensões Câmara / Dimensions chambre / Dimensiones cámara / Chamber Dimensions	mm	1080x720x150	1080x720x150
Nº Pizzas / N° Pizzas / N° Pizzas / Pizzas No.	nr (mm)	6 (Ø300)	6 + 6 (Ø300)
Potência / Puissance / Potencia / Power	kW	7,8	15,6
Tensão / Tension / Tensión / Tension	V	400	400





## EVOLUTION



Forno elétrico com sistema de controlo digital, regulação independente do grupo superior e inferior das resistências, aviso sonoro de final de ciclo.



Founeau électrique de commande numérique, régulation indépendante des groupes de résistances supérieur et inférieur, avertisseur sonore de fin de cycle.



Horno eléctrico con sistema de control digital, regulación independiente del grupo superior e inferior de las resistencias, aviso sonoro de final de ciclo.



Electric oven with digital control system, independent regulation of the upper and lower group of resistors, sound warning of end of cycle.



As rodas são opcionais (sob consulta)  
Les roues sont optionnelles (sur demande)  
Las ruedas son opcionales (bajo consulta)  
Wheels are optional (On request)

### HOTTE VENTILADA / HOTTE VENTILÉS / HOTTE VENTILADA / VENTILATED HOTTE

Cód.	Ref.	€
2110.834	KCR835AS C/ ASPIRAÇÃO	4.454,00



### SUPORTE / SUPPORT / SOPORTE / SUPPORT

Cód.	Ref.	€
2110.829	SCR835/1 P/ MODELO CR835/1CD	1.533,00
2110.831	SCR835/2 P/ MODELO CR835/2CD	1.533,00



MODELO / MODÈLE / MODELO / MODEL		CR835/1CD	CR835/2CD
CÓDIGO / CODE / CÓDIGO / CODE		2110.821	2110.823
<b>Preço / Prix / Precio / Price</b>	<b>€</b>	<b>8.832,00</b>	<b>15.608,00</b>
Dimensões Embalagem / Dimensions Emblage / Dimensiones Embalaje / Packaged Dimensions	mm	1600x1680x615	1600x1680x960
Largura Câmara / Largeur Chambre / Ancho Cámara / Chamber Width	mm	1181	1181
Profundidade da Câmara / Profondeur de la chambre / Profundidad de la cámara / Chamber Depth	mm	1181	1181
Altura da Câmara / Hauteur de la chambre / Altura de la cámara / Chamber Height	mm	138	138
Nº Pizzas / N° Pizzas / N° Pizzas / Pizzas No.	nr (mm)	8 (Ø350) - 4 (Ø500)	8+8 (Ø350) 4+4 (Ø500)
Potência / Puissance / Potencia / Power	kw	11,8	11,8+11,8
Peso Líquido / Poids Net / Peso Neto / Net Weight	kg	306	520
Tensão / Tension / Tensión / Tension	V	400	400



opcional  
optionnel  
opcional  
optional



confirmar disponibilidade  
confirmer la disponibilité  
confirmar la disponibilidad  
confirm the availability





UDI

**FORNOS DE PIZZA - ELÉTRICOS**  
FOURS À PIZZA - ÉLECTRIQUES  
HORNOS PARA PIZZA - ELÉTRICOS  
OVENS FOR PIZZA - ELECTRIC



**GIOTTO**



**NOVO  
NOUVEAU  
NUEVO  
NEW**

As rodas são opcionais (sob consulta)  
Les roues sont optionnelles (sur demande)  
Las ruedas son opcionales (bajo consulta)  
Wheels are optional (On request)

**HOTTE VENTILADA / HOTTE VENTILÉS / HOTTE VENTILADA / VENTILATED HOTTE**



Cód.	Ref.	Dim.	Peso	Extração	€
2110.770	KGTA	SEM ASPIRAÇÃO	1205x1452x408	53kg	- 3.921,00
2110.772	KGTAS	COM ASPIRAÇÃO	1205x1452x408	58kg	700m <sup>3</sup> /h 4.480,00

MODELO / MODÈLE / MODELO / MODEL		GT110/1TS	GT140/1TS
CÓDIGO / CODE / CÓDIGO / CODE		2110.766	2110.768
Preço / Prix / Precio / Price	€	22.153,00	24.707,00
Dimensões Embalagem / Dimensions Embalage / Dimensiones Embalaje / Packaged Dimensions	mm	1366x1438x1697	1667x1738x1697
Dimensões Câmara / Dimensions Chambre / Dimensiones Cámara / Chamber Dimensions	mm	620,5x1100x180	620,5x1400x180
Nº Pizzas / N° Pizzas / N° Pizzas / Pizzas No.	nr (mm)	7 (Ø350) - 3(Ø500)	10(300) / 5(500)
Potência / Puissance / Potencia / Power	kW	9,7	11,9
Peso Líquido / Poids Net / Peso Neto / Net Weight	kg	517-588	636-722
Tensão / Tension / Tensión / Tension	V	400	400



**UDM85RK**  
**2111.553**

 C/ revestimento silicone  
 Con revestimiento de silicona  
 Avec revêtement en silicone  
 With silicone coating

**UXIM85RK**  
**2111.552**

 C/ revestimento mosaico  
 Avec revêtement en mosaïque  
 Con revestimiento de mosaico  
 With mosaic coating

**UDM120RK**  
**2111.557**

 C/ revestimento silicone  
 Avec revêtement en silicone  
 Con revestimiento de silicona  
 With silicone coating

**UDIXM120RK**  
**2111.556**

 C/ revestimento mosaico  
 Avec revêtement en mosaïque  
 Con revestimiento de mosaico  
 With mosaic coating

**Gás, Gaz, Gas**  
**GPL / NATURAL**

MODELO / MODÈLE / MODELO / MODEL		UDM85RK SILICONE	UXIM85RK MOSAICO	UDM120RK SILICONE	UDIXM120RK MOSAICO
CÓDIGO / CODE / CÓDIGO / CODE		2111.553	2111.552	2111.557	2111.556
<b>Preço / Prix / Precio / Price</b>	€	<b>21.907,00</b>	<b>26.391,00</b>	<b>41.247,00</b>	<b>46.523,00</b>
Dimensões / Dimensions / Dimensiones	mm	1450x1520x1860	1450x1520x1860	1960x2150x2050	1960x2150x2050
Capacidade / Capacité / Capacidad / Capacity	nr	4	4	9	9
Produção / Production / Produccion / Production	n/h	60	60	135	135
Consumo GPL30-31 / Consomation GPL30-31 / Consumo GPL30-31 / Consumption GPL30-31	kg/h	1,7	1,7	1,9	1,9
Consumo G20 (Gas natural) / Consomation G20 (Gas Naturel) / Consumo G20 (Gas Natural) / Consumption G20 (Natural Gas)	mc/h	3	3	3,3	3,3
Peso / Poids / Peso / Weight	kg	950	950	1950	1950
Power / Puissance / Potência / Power	kW	22	22	26	26
Tensão / Tension / Tension / Tension	V	230	230	230	230

Tempo Arranque: 3 dias de queima. Mais informação no Manual / Temps de démarrage: 3 jours de combustion. Plus d'informations dans le Manuel d'équipement / Tiempo de Arranque: 3 días de queima. Más información en el Manual / Booting Time: 3 days of burning. Refer to the Equipment Manual

O transporte é por conta e risco do cliente a partir da sede na Maia / Le transport est à la charge du client du siège à Maia / El transporte es por cuenta y riesgo del cliente a partir de la sede en Maia / Transportation is at the customer's own risk from the headquarters in Maia



UDI



artigos fornecidos sob pedido  
articles fournis sur demande  
artículos suministrados bajo pedido  
items supplied on request

**FORNOS DE PIZZA LENHA / GÁS COM BASE FIXA**

**FOURS À PIZZA BOIS / GAZ A BASE FIXE**

**HORNOS PIZZA MADERA / GAS CON BASE FIJA**

**WOOD/GAS STATIC BASE PIZZA OVEN**



MODELO / MODÈLE / MODELO / MODEL		UDXM120V	UDXIM140V
CÓDIGO / CODE / CÓDIGO / CODE		2111.562	2111.560
<b>Preço / Prix / Precio / Price</b>	<b>€</b>	<b>23.794,00</b>	<b>26.421,00</b>
Dimensões / Dimensions / Dimensiones	mm	1900x2170x1880	2250x2160x1880
Capacidade / Capacite / Capacidad / Capacity	nr	9	13
Produção / Production / Produccion / Production	n/h	135	195
Consumo GPL30-31 / Consomation GPL30-31 / Consumo GPL30-31 / Consumption GPL30-31	kg/h	1,9	3,2
Consumo G20 (Gas natural) / Consomation G20 (Gas Naturel) / Consumo G20 (Gas Natural) / Consumption G20 (Natural Gas)	mc/h	3,3	4,2
Peso / Poids / Peso / Weight	kg	1950	2100
Power / Puissance / Potência / Power	kw	26	30
Tensão / Tension / Tension / Tension	V	230	230

Tempo Arranque: 3 dias de queima. Mais informação no Manual / Temps de démarrage: 3 jours de combustion. Plus d'informations dans le Manuel d'équipement / Tiempo de Arranque: 3 días de queima. Más información en el Manual / Booting Time: 3 days of burning. Refer to the Equipment Manual

O transporte é por conta e risco do cliente a partir da sede na Maia / Le transport est à la charge du client du siège à Maia / El transporte es por cuenta y riesgo del cliente a partir de la sede en Maia / Transportation is at the customer's own risk from the headquarters in Maia



C/ revestimento mosaico  
 Avec revêtement en mosaïque  
 Con revestimiento de mosaico  
 With mosaic coating



C/ revestimento silicone  
 Avec revêtement en silicone  
 Con revestimiento de silicona  
 With silicone coating



**Gás, Gaz, Gas  
 GPL / NATURAL**

MODELO / MODÈLE / MODELO / MODEL		URG85K	URG110K	URG130K	URG85K	URG110K	URG130K
CÓDIGO / CODE / CÓDIGO / CODE		2111.566	2111.568	2111.570	2111.567	2111.569	2111.571
<b>Preço / Prix / Precio / Price</b>	<b>€</b>	<b>29.728,00</b>	<b>38.476,00</b>	<b>41.410,00</b>	<b>25.333,00</b>	<b>35.136,00</b>	<b>37.076,00</b>
Dimensões / Dimensions / Dimensiones	mm	1450x 1700x 2050	1710x 1900x 2050	1910x 2150x 2050	1450x 1700x 2050	1710x 1900x 2050	1910x 2150x 2050
Capacidade / Capacité / Capacidad / Capacity	nr	4	8	11	4	8	11
Produção / Production / Produccion / Production	n/h	60	120	165	60	120	165
Consumo GPL30-31 / Consomation GPL30-31 / Consumo GPL30-31 / Consumption GPL30-31	kg/h	1,7	1,9	2,1	1,7	1,9	2,1
Consumo G20 (Gas natural) / Consomation G20 (Gas Naturel) / Consumo G20 (Gas Natural) / Consumption G20 (Natural Gas)	mc/h	3	3,3	3,5	3	3,3	3,5
Peso / Poids / Peso / Weight	kg	1250	1400	1900	1250	1400	1900
Power / Puissance / Potência / Power	kW	22	26	30	22	26	30
Tensão / Tension / Tension / Tension	V	230	230	230	230	230	230

Tempo Arranque: 3 dias de queima. Mais informação no Manual / Temps de démarrage: 3 jours de combustion. Plus d'informations dans le Manuel d'équipement / Tiempo de Arranque: 3 días de queima. Más información en el Manual / Booting Time: 3 days of burning. Refer to the Equipment Manual

O transporte é por conta e risco do cliente a partir da sede na Maia / Le transport est à la charge du client du siège à Maia / El transporte es por cuenta y riesgo del cliente a partir de la sede en Maia / Transportation is at the customer's own risk from the headquarters in Maia



artigos fornecidos sob pedido  
articles fournis sur demande  
artículos suministrados bajo pedido  
items supplied on request

**FORNOS DE PIZZA GÁS COM BASE FIXA**  
FOURS À PIZZA GAZ A BASE FIXE  
HORNOS PIZZA GAS CON BASE FIJA  
GAS STATIC BASE PIZZA OVEN

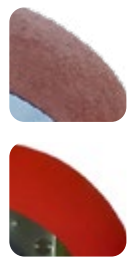
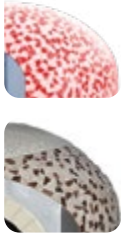

Gás, Gaz, Gas  
GPL / NATURAL

C/ revestimento mosaico  
Avec revêtement en mosaïque  
Con revestimiento de mosaico  
With mosaic coating

C/ revestimento silicone  
Avec revêtement en silicone  
Con revestimiento de silicone  
With silicone coating

MODELO / MODÈLE / MODELO / MODEL		UG120K	UG140K	UG160K	UG120K	UG140K	UG160K
CÓDIGO / CODE / CÓDIGO / CODE		MOSAICO	MOSAICO	MOSAICO	SILICONE	SILICONE	SILICONE
		2111.572	2111.574	2111.576	2111.573	2111.575	2111.577
<b>Preço / Prix / Precio / Price</b>	<b>€</b>	<b>24.927,00</b>	<b>27.982,00</b>	<b>31.043,00</b>	<b>21.311,00</b>	<b>23.709,00</b>	<b>25.939,00</b>
Dimensões / Dimensions / Dimensiones	mm	1710x 1900x 2050	1910x 2150x 2050	2100x 2350x 2050	1710x 1900x 2050	1910x 2150x 2050	2100x 2350x 2050
Capacidade / Capacité / Capacidad / Capacity	nr	7	10	13	7	10	13
Produção / Production / Produccion / Production	n/h	105	150	195	105	150	195
Consumo GPL30-31 / Consomation GPL30-31 / Consumo GPL30-31 / Consumption GPL30-31	kg/h	1,9	3,2	3,8	1,9	3,2	3,8
Consumo G20 (Gas natural) / Consomation G20 (Gas Naturel) / Consumo G20 (Gas Natural) / Consumption G20 (Natural Gas)	mc/h	3,3	4,2	4,5	3,3	4,2	4,5
Peso / Poids / Peso / Weight	kg	1400	1800	2150	1400	1800	2150
Power / Puissance / Potência / Power	kW	26	30	36	26	30	36
Tensão / Tension / Tension / Tension	V	230	230	230	230	230	230

Tempo Arranque: 3 dias de queima. Mais informação no Manual / Temps de démarrage: 3 jours de combustion. Plus d'informations dans le Manuel d'équipement / Tiempo de Arranque: 3 días de queima. Más información en el Manual / Booting Time: 3 days of burning. Refer to the Equipment Manual

O transporte é por conta e risco do cliente a partir da sede na Maia / Le transport est à la charge du client du siège à Maia / El transporte es por cuenta y riesgo del cliente a partir de la sede en Maia / Transportation is at the customer's own risk from the headquarters in Maia



Fornos de túnel modulares ventilados para pizzeria, panificação, pastelaria, e gastronomia.  
Equipados com tapete (cinta em malha de arame) e Controlos eletrónicos.  
Funcionamento simples e versátil (diferentes tipos de produtos)  
Consumo reduzido de energia  
Otimização dos tempos de operação (tapete de transporte automático)  
Autonomia (configuração exata da temperatura e tempo)  
Ergonomia (o tapete transportador permite retirar os produtos confeccionados com facilidade)



Fours modulaires à tunnel pour pizza, pain, pâtisserie et gastronomie.  
Tapis transporteur (tapis métallique grillagé) et commandes électroniques (platine électronique de gestion du fonctionnement).  
Fonctionnement simple et polyvalent (différents types de produits)  
Consommation d'énergie réduite  
Optimisation des temps de fonctionnement (Tapis de transport automatique)  
Autonomie (configuration exacte de la température et du temps)  
Ergonomie (Le tapis permet le retrait des produits prêts facilement)



Hornos modulares a túnel (patentados) para pizza, pan, pastelería y gastronomía a ventilación.  
Provisos de cinta transportadora (en red de alambre) y mandos electrónicos.  
Sencillo y versátil (diferentes tipos de productos)  
Consumo de energía reducido  
Optimización del tiempo de funcionamiento (Cinta transportadora automática)  
Autonomía (configuración exacta de la temperatura y del tiempo)  
Ergonomía (La cinta transportadora permite la retirada de los productos cocinados con facilidad)



Modular ventilated tunnel ovens (patented) for pizza, bread, pastry and delicatessen. Conveyor belt (mesh) and electronic controls.  
Simple and versatile (different types of products)  
Reduced energy consumption  
Optimization of operation times (Automatic conveyor transport)  
Autonomy (exact configuration of the temperature and time)  
Ergonomics (The conveyor belt allows that the ready products can be easily taken)



**SYNTHESIS  
06/40VE  
2108.102**



**SYNTHESIS 08/50VPWE 2108.104**   **SYNTHESIS 11/65VE 2108.106**

Suporte Não Incluído / Support Non Inclui  
Soporte No Incluido / Stand Not Included

**06/40**

Pizza Italiana Pizza Italienne Pizza Italiana Italian Pizza ø cm	Tempo de Cozedura Temps de Cuisson Tiempo de Cocción Baking Time min.	Nº Pizzas/Hora Nº Pizzas/Heure Nº Pizzas/Hora Hour/Pizzas No.
15 (80 gr.)	3,5 - 4	145 - 115
20 (145 gr.)	3,5 - 4	80 - 75
25 (230 gr.)	3,5 - 4	45 - 40
30 (330 gr.)	3,5 - 4,5	35 - 25
35 (450 gr.)	4 - 4,5	27 - 21
40 (585 gr.)	4 - 5	21 - 18

**08/50**

Pizza Italiana Pizza Italienne Pizza Italiana Italian Pizza ø cm	Tempo de Cozedura Temps de Cuisson Tiempo de Cocción Baking Time min.	Nº Pizzas/Hora Nº Pizzas/Heure Nº Pizzas/Hora Hour/Pizzas No.
20 (145 gr.)	3,5 - 4	135 - 120
25 (230 gr.)	3,5 - 4	90 - 80
30 (330 gr.)	3,5 - 4,5	60 - 50
35 (450 gr.)	3,5 - 4,5	45 - 35
40 (585 gr.)	4 - 5	30 - 25
45 (740 gr.)	4,5 - 5,5	25 - 20

**OPCIONAL / OPTIONNEL / OPTATIVO / OPTIONAL**

Cód.	Ref.	€
2108.254	Suporte em inox para o forno elétrico modelo SYNTHESIS 06/40VE.	<b>CONSULTAR</b>

MODELO / MODÈLE / MODELO / MODEL		SYNTHESIS 06/40VE	SYNTHESIS 08/50VPWE	SYNTHESIS 11/65VE
CÓDIGO / CODE / CÓDIGO / CODE		2108.102	2108.104	2108.106
<b>Preço / Prix / Precio / Price</b>	€	<b>9.872,00</b>	<b>16.836,00</b>	<b>21.665,00</b>
Dimensões / Dimensions / Dimensiones	mm	980x1300x440	1260x1750x490	1400x2000x550
Largura da Câmara / Largeur de la chambre / Ancho de la cámara / Chamber Width	mm	400	500	650
Profundidade da Câmara / Profondeur de la chambre / Profundidad de la cámara / Chamber Depth	mm	580	850	1100
Altura da Câmara / Hauteur de la chambre / Altura de la cámara / Chamber Height	mm	95	100	100
Temperatura / Température / Temperatura / Temperature	°C	320	320	320
Suporte / Support / Soporte / Stand	x/√	x	√	√
Peso Líquido-Bruto / Poids Net-Brut / Peso Neto-Bruto / Net-Gross Weight	Kg	105	180	222
Potência / Puissance / Potencia / Power	kW	7,9	13,8	18
Tensão / Tension / Tensión / Tension	V	400	400	400

√ - INCLuíDO / INCLU / INCLUIDO / INCLUDED  
x - NÃO INCLuíDO / NON INCLU / NO INCLUIDO / NOT INCLUDED



UDI

**FORNOS DE TÚNEL - PIZZA - GÁS**  
FOURS DE TUNNEL - PIZZA - GAZ  
HORNOS DE TÚNEL - PIZZA - GAS  
TUNNEL OVENS - PIZZA - GAS



**SYNTHESIS  
11/65VGAS  
2108.112**

**11/65**

Pizza Italiana Pizza Italienne Italian Pizza ø cm	Tempo de Cozedura Temps de Cuisson Tiempo de Cocción Baking Time min.	Nº Pizzas/Hora Nº Pizzas/Heure Nº Pizzas/Hora Hour/Pizzas No.
25 (230 gr.)	3,5-4	155-140
30 (330 gr.)	3,5-4,5	110-85
35 (450 gr.)	3,5-4,5	80-60
40 (585 gr.)	4-5	60-45
45 (740 gr.)	4,5 - 5,5	40-30
50 (915 gr.)	5-6	30-25



MODELO / MODÈLE / MODELO / MODEL		SYNTHESIS 06/40V GAS 2108.108	SYNTHESIS 08/50VPWGAS 2108.110	SYNTHESIS 11/65VGAS 2108.112
CÓDIGO / CODE / CÓDIGO / CODE				
<b>Preço / Prix / Precio / Price</b>	<b>€</b>	<b>10.167,00</b>	<b>16.983,00</b>	<b>21.841,00</b>
Dimensões / Dimensions / Dimensiones	mm	1030x1300x440	1260x1750x490	1560x2000x550
Largura da Câmara / Largeur de la chambre / Ancho de la cámara / Chamber Width	mm	400	500	650
Profundidade da Câmara / Profondeur de la chambre / Profundidad de la cámara / Chamber Depth	mm	580	850	1100
Altura da Câmara / Hauteur de la chambre / Altura de la cámara / Chamber Height	mm	95	100	100
Temperatura / Température / Temperatura / Temperature	°C	320	320	320
Consumo GPL 30/31 / Consommation GPL 30/31 / Consumo GPL 30/31 / Consumption GPL 30/31	kg/h	0,33	0,52	0,90
Consumo G20 (Gás Natural) / Consommation G20 (Gaz Naturel) / Consumo G20 ( Gas Natural) / Consumption G20 (Natural Gas)	m³/h	0,83	1,32	2,29
Potência Nominal / Puissance nominale / Potencia nominal / Rated power	Qn/kW	9	13,9	24
Suporte / Support / Soporte / Stand	x/√	x	√	√
Peso Líquido-Bruto / Poids Net-Brut / Peso Neto-Bruto / Net-Gross Weight	Kg	115	200	252
Potência / Puissance / Potencia / Power	kW	0,44	0,44	0,81
Tensão / Tension / Tensión / Tension	V	230	230	230

√ - INCLUÍDO / INCLU / INCLUIDO / INCLUDED  
X - NÃO INCLUÍDO / NON INCLU / NO INCLUIDO / NOT INCLUDED

**Interior e exterior em aço inoxidável**  
**Câmara interior com cantos arredondados**  
**Sistema interno de ventilação**  
**Puxador tubular em aço inoxidável**  
**Temporizador 60 minutos**  
**Termostato 280 °C**  
**Iluminação interna**  
**Suportes de tabuleiros removíveis**

**Intérieur et extérieur en acier inoxydable**  
**Chambre intérieure avec coins arrondis**  
**Système intérieur de ventilation**  
**Poignée tubulaire en acier inoxydable**  
**Minuterie de 60 minutes**  
**Thermostat 280 °C**  
**L'éclairage intérieur**  
**Détenteurs de plateaux amovible**

**Interior y exterior en acero inoxidable**  
**Cámara interior con esquinas redondeadas**  
**Interior del sistema de ventilación**  
**Manija tubular acero inoxidable**  
**Timer 60 minutos**  
**Termostato 280 °C**  
**Iluminación interior**  
**Suporte bandeja extraíble**

**Inside and Outside made of Stainless Steel**  
**Cooking chamber with round corners**  
**Internal ventilation system**  
**Stainless Steel tubular handle**  
**60 minute timer**  
**280 °C thermostat**  
**Internal lighting**  
**Removable guides support**



**3x**  
**2/3GN**  
**354x325mm**

**NOVO**  
**NOUVEAU**  
**NUEVO**  
**NEW**



280 °C



60 min.

**Tabuleiros são opcionais / Plateaux en option / Bandejas opcionales / Trays are optional**

MODELO / MODÈLE / MODELO / MODEL	UDFCE3
CÓDIGO / CODE / CÓDIGO / CODE	3X 2/3GN
	2930.043
<b>Preço / Prix / Precio / Price</b>	<b>€ 876,00</b>
Dimensões / Dimensions / Dimensiones	mm 600x530x400
Dimensões Câmara / Dim. Chambre / Dim. Câmara / Chamber Dim.	mm 390x370x250
Dimensões Embalagem / Dim. Emballage / Dim. Embalaje / Packaging Dim.	mm 700x570x560
Espaço entre Tabuleiros / Espace plateaux / Espacio entre bandejas / Trays space	mm 80
Peso Líquido-Bruto / Poids Net-Brut / Peso Neto-Bruto / Net-Gross Weight	kg 21/30
Potência / Puissance / Potencia / Power	kW 2,5 (10,8A)
Tensão / Tension / Tensión / Tension	V 230

**4x**  
**435x350mm**



280 °C



60 min.

**2x**  
**435x350mm**



**Tabuleiros incluídos / Plateaux inclus / Bandejas incluidas / Trays included**

MODELO / MODÈLE / MODELO / MODEL	4X
CÓDIGO / CODE / CÓDIGO / CODE	435X350MM
	2930.040
<b>Preço / Prix / Precio / Price</b>	<b>€ 984,00</b>
Dimensões / Dimensions / Dimensiones	mm 589x660x580
Dimensões Câmara / Dim. Chambre / Dim. Câmara / Chamber Dim.	mm 464x420x370
Dimensões Embalagem / Dim. Emballage / Dim. Embalaje / Packaging Dim.	mm 625x720x725
Espaço entre Tabuleiros / Espace plateaux / Espacio entre bandejas / Trays space	mm 84
Peso Líquido-Bruto / Poids Net-Brut / Peso Neto-Bruto / Net-Gross Weight	kg 34/41
Potência / Puissance / Potencia / Power	kW 3,1 (14A)
Tensão / Tension / Tensión / Tension	V 230

**4x**  
**1/1 GN**



280 °C



60 min.

**Tabuleiros são opcionais / Plateaux en option / Bandejas opcionales / Trays are optional**

MODELO / MODÈLE / MODELO / MODEL	UDFCE4
CÓDIGO / CODE / CÓDIGO / CODE	4X1/1GN
	2930.044
<b>Preço / Prix / Precio / Price</b>	<b>€ 1.041,00</b>
Dimensões / Dimensions / Dimensiones	mm 686x660x580
Dimensões Câmara / Dim. Chambre / Dim. Câmara / Chamber Dim.	mm 560x420x370
Dimensões Embalagem / Dim. Emballage / Dim. Embalaje / Packaging Dim.	mm 725x720x725
Espaço entre Tabuleiros / Espace plateaux / Espacio entre bandejas / Trays space	mm 84
Peso Líquido-Bruto / Poids Net-Brut / Peso Neto-Bruto / Net-Gross Weight	kg 37/45
Potência / Puissance / Potencia / Power	kW 3,1 (14A)
Tensão / Tension / Tensión / Tension	V 230

**OPCIONAL / OPTIONNEL / OPTATIVO / OPTIONAL**

Cód.	Ref.	€
2930.042	1 x TABULEIRO ADICIONAL 435x350mm	23,00







UDI

**FORNOS CONVECTORES ELÉTRICOS - MECÂNICOS - PASTELARIA - GRILL**  
**FOURS À CONVECTION ÉLECTRIQUES - MÉCANIQUES - PÂTISSERIE**  
**HORNOS CONVECTORES ELÉCTRICOS - MECÁNICO - PASTELERÍA**  
**ELECTRIC / GAS CONVECTION OVENS - MECHANICAL - PASTRY**



**Interior e exterior em aço inoxidável**  
**Câmara interior com cantos arredondados**  
**Sistema interno de ventilação**  
**Puxador tubular em aço inoxidável**  
**Temporizador 60 minutos**  
**Termostato 280 °C**  
**Iluminação interna**  
**Suportes de tabuleiros removíveis**

**Intérieur et extérieur en acier inoxydable**  
**Chambre intérieure avec coins arrondis**  
**Système intérieur de ventilation**  
**Poignée tubulaire en acier inoxydable**  
**Minuterie de 60 minutes**  
**Thermostat 280 °C**  
**L'éclairage intérieur**  
**Détenteurs de plateaux amovible**

**Interior y exterior en acero inoxidable**  
**Cámara interior con esquinas redondeadas**  
**Interior del sistema de ventilación**  
**Manija tubular acero inoxidable**  
**Timer 60 minutos**  
**Termostato 280 °C**  
**Iluminación interior**  
**Suporte bandeja extraíble**

**Inside and Outside made of Stainless Steel**  
**Cooking chamber with round corners**  
**Internal ventilation system**  
**Stainless Steel tubular handle**  
**60 minute timer**  
**280 °C thermostat**  
**Internal lighting**  
**Removable guides support**



**4x**  
**1/1 GN**

**NOVO**  
**NOUVEAU**  
**NUEVO**  
**NEW**



280 °C



60 min.

**GRILL** .....

**Tabuleiros são opcionais / Plateaux en option / Bandejas opcionales / Trays are optional**

MODELO / MODÈLE / MODELO / MODEL	UDFCGE4
CÓDIGO / CODE / CÓDIGO / CODE	4X1/1GN GRILL
<b>Preço / Prix / Precio / Price</b>	<b>€ 1.160,00</b>
Dimensões / Dimensions / Dimensiones	mm 685x680x580
Dimensões Câmara / Dim. Chambre / Dim. Câmara / Chamber Dim.	mm 560x420x370
Dimensões Embalagem / Dim. Emballage / Dim. Embalaje / Packaging Dim.	mm 725x720x750
Espaço entre Tabuleiros / Espace plateaux / Espacio entre bandejas / Trays space	mm 84
Peso Líquido-Bruto / Poids Net-Brut / Peso Neto-Bruto / Net-Gross Weight	kg 37-50
Potência / Puissance / Potencia / Power	kW 3,15+1,7
Tensão / Tension / Tensión / Tension	V 230

**3x**  
**600x400 mm**

**NOVO**  
**NOUVEAU**  
**NUEVO**  
**NEW**



280 °C



60 min.

**GRILL** .....

**Tabuleiros são opcionais / Plateaux en option / Bandejas opcionales / Trays are optional**

MODELO / MODÈLE / MODELO / MODEL	UDFCGE3
CÓDIGO / CODE / CÓDIGO / CODE	3T 60X40
<b>Preço / Prix / Precio / Price</b>	<b>€ 1.018,00</b>
Dimensões / Dimensions / Dimensiones	mm 775x720x560
Dimensões Câmara / Dim. Chambre / Dim. Câmara / Chamber Dim.	mm 650x459x350
Dimensões Embalagem / Dim. Emballage / Dim. Embalaje / Packaging Dim.	mm 800x750x730
Espaço entre Tabuleiros / Espace plateaux / Espacio entre bandejas / Trays space	mm 105
Peso Líquido-Bruto / Poids Net-Brut / Peso Neto-Bruto / Net-Gross Weight	kg 40-55
Potência / Puissance / Potencia / Power	kW 3,15
Tensão / Tension / Tensión / Tension	V 230

**3x**  
**600x400 mm**

**NOVO**  
**NOUVEAU**  
**NUEVO**  
**NEW**



280 °C



60 min.

**Tabuleiros são opcionais / Plateaux en option / Bandejas opcionales / Trays are optional**

MODELO / MODÈLE / MODELO / MODEL	UDFCGE3
CÓDIGO / CODE / CÓDIGO / CODE	3T 60X40 GRILL
<b>Preço / Prix / Precio / Price</b>	<b>€ 1.306,00</b>
Dimensões / Dimensions / Dimensiones	mm 775x720x560
Dimensões Câmara / Dim. Chambre / Dim. Câmara / Chamber Dim.	mm 650x459x350
Dimensões Embalagem / Dim. Emballage / Dim. Embalaje / Packaging Dim.	mm 800x750x730
Espaço entre Tabuleiros / Espace plateaux / Espacio entre bandejas / Trays space	mm 105
Peso Líquido-Bruto / Poids Net-Brut / Peso Neto-Bruto / Net-Gross Weight	kg 40-55
Potência / Puissance / Potencia / Power	kW 3,15+1,7
Tensão / Tension / Tensión / Tension	V 230



Forno fabricado interior e exterior em aço inox com acabamento em Scotch Bright; Câmara com ângulos arredondados; Painel de comando digital; 9 programas; Função de arrefecimento no final da cozedura; Injeção manual ou automática de H2O; Delta T° cozimento; **Sondas ao centro** Duplo motor e dupla ventilação; Sistema interno de ventilação por difusão global com ventiladores de inversão de marcha; Puxador tubular em aço inox; Termostato 280°C; Iluminação interna; Porta de vidro fria com vidro interno removível de baixa emissibilidade; Abertura da porta lateral direita ou esquerda (opção); Microinterruptor de porta; Suporte removível de guias anti-tombamento.



Intérieur et extérieur du four en acier inoxydable avec finition Scotch Bright; Chambre aux angles arrondis; Panneau de commande numérique; 9 programmes; Fonction de refroidissement en fin de cuisson; Injection manuelle ou automatique d H2O; Delta T de cuisson; **Sondes à coeur** Double moteur et double ventilation; Système interne de ventilation à diffusion globale avec ventilateurs réversibles; Poignée tubulaire en acier inoxydable; Thermostat 280°C; Éclairage intérieur; Porte vitrée froide avec vitre interne amovible à faible émission; Ouverture de la porte latérale droite ou gauche (option); Micro-interrupteur de porte; Support amovible pour guides anti-basculément.



Horno fabricado interior y exterior en acero inoxidable con calefacción Scotch Bright; Panel de comando digital 9 programas; Arrefecimento função no final da cozedura; Inyección de H2O manual o automática; Delta T de Coción; Sondas de núcleo Doble motor y doble ventilación; Sistema de ventilación interna para difusión global con ventiladores de marcha atrás; Puxador tubular de acero inoxidable; Termostato 280°C; iluminación interior; Porta de vidro fria com vidro interno removível de baixa emissibilidade; Abertura desde puerta lateral directa o salida (opción) microinterruptor de puerta; Quita soportes de guias anti-tumbamiento.



Oven made interior and exterior in stainless steel with Scotch Bright finish; Chamber with rounded angles; Digital command panel; 9 programs; Cooling function at the end of cooking; Manual or automatic H2O injection; Delta T° cooking; **Core probes** Double motor and double ventilation; Internal global diffusion ventilation system with reversing fans; Stainless steel tubular handle; Thermostat 280°C; Internal lighting; Cold glass door with removable low-emission internal glass; Opening the right or left side door (option); Door microswitch; Removable support for anti-tip guides.

**NOVO  
NOUVEAU  
NUEVO  
NEW**



**6x**  
1/1 GN  
600x400mm



280 °C

MODELO / MODÈLE / MODELO / MODEL	FORNO CONVETOR	
CÓDIGO / CODE / CÓDIGO / CODE	2930.060	
<b>Preço / Prix / Precio / Price</b>	€	<b>3.558,00</b>
Dimensões / Dimensions / Dimensiones	mm	840x920x835
Dimensões Câmara / Dim. Chambre / Dim. Câmara / Chamber Dim.	mm	680x480x520
Capacidade Tabuleiros /Capac. Plateaux /Capaci. Bandejas /Chamber Capac.	GN-mm	6 x 1/1-600x400
Espaço entre Prateleiras / Espace Étagères / Espacio Estantes / Shelves space	mm	80
Peso Líquido - Bruto / Poids Net - Brut / Peso Net - Bruto / Net - Gross Weight	kg	90-110
Potência Total / Puissance Total / Potencia Total / Total Power	kW	7,65
Tensão / Tension / Tensión / Tension	V	400



**10x**  
1/1 GN  
600x400mm



280 °C

MODELO / MODÈLE / MODELO / MODEL	FORNO CONVETOR	
CÓDIGO / CODE / CÓDIGO / CODE	2930.062	
<b>Preço / Prix / Precio / Price</b>	€	<b>4.510,00</b>
Dimensões / Dimensions / Dimensiones	mm	840x920x1155
Dimensões Câmara / Dim. Chambre / Dim. Câmara / Chamber Dim.	mm	680x480x840
Capacidade Tabuleiros /Capac. Plateaux /Capaci. Bandejas /Chamber Capac.	GN-mm	10 x 1/1-600x400
Espaço entre Prateleiras / Espace Étagères / Espacio Estantes / Shelves space	mm	80
Peso Líquido - Bruto / Poids Net - Brut / Peso Net - Bruto / Net - Gross Weight	kg	125-150
Potência Total / Puissance Total / Potencia Total / Total Power	kW	-
Tensão / Tension / Tensión / Tension	V	400



UDI

**FORNOS CONVETORES ELETRICO DIGITAIS - GASTRONOMIA / PASTELARIA**  
FOURS À CONVECTION ÉLECTRIQUES NUMÉRIQUES - GASTRO / PÂTISSERIE  
HORNOS CONVETORES ELÉCTRICOS DIGITALES - GASTRO / PASTELERÍA  
ELECTRIC DIGITAL CONVECTION OVENS - GASTRO / PASTRY



**NOVO**  
**NOUVEAU**  
**NUEVO**  
**NEW**



**Sonda ao centro**  
Plateaux inclus  
Bandejas incluidas  
Trays included



Interior e exterior em aço inoxidável com acabamento Scotch externo Brilhante; Versão M : Ventilados; Câmara de cozedura em aço inox AISI430; Controlo de temperatura por termostato; seleção temporizador e iluminação; UDFCEM423: Sem Humidificador UDFCEMH423: Com Humidificação indireta. UDFCEMM423: Forno Multifunções; 8 opções de cozedura; cozedura estática, descongelação, tradicional ventilada, ventilada com grill.

Intérieur et extérieur en acier inoxydable avec Scotch externe au fini brillant; Double moteur et ventilateur. Version M : Ventilés; Chambre en AISI430 en acier inoxydable de cuisson; Contrôle de la température par thermostat; Sélection de temporisateur; Éclairage; UDFCEM423: Non Humidificateur UDFCEMH423: Avec humidification indirecte UDFCEMM423: Four multifonctions; 8 options de cuisson; cuisson statique, décongélant, traditionnel ventilé, ventilé.

Interior y exterior en acero inoxidable con acabado externo brillante Scotch; Motor doble y ventilador. Versión M : Ventilados; Cámara de cocción en AISI430 de acero inoxidable; Control de la temperatura por termostato; Selección del temporizador; Iluminación; UDFCEM423: Sin humidificador UDFCEMH423: Con humidificación indirecta UDFCEMM423: Horno multifunción; 8 opciones de cocción; descongelación, cocción estática, tradicional ventilada, ventilada con grill.

Inside and Outside made of Stainless Steel with external Scotch Bright finishing; Double motor and double fans. M Version: Ventilated; Cooking chamber in stainless steel AISI430; Thermostatically temperature control; Timer selection; lighting; UDFCEM423: without Humidifier UDFCEMH423: With indirect humidification. UDFCEMM423: Multifunction Oven; 8 cooking options; static cooking, defrost, traditional ventilated, ventilated grill.



Multifunções



**4x**  
429x345x9mm

Tabuleiros Alumínio incluídos  
Plateaux Aluminium inclus  
Bandejas Alumínio incluídas  
Aluminum Trays included

Sem Humidificador / Pas d'humidificateur / Sin humidificador / Without Humidifier



MODELO / MODÈLE / MODELO / MODEL	UDFCEM423	
CÓDIGO / CODE / CÓDIGO / CODE	2106.103	
<b>Preço / Prix / Precio / Price</b>	<b>€</b>	<b>971,00</b>
Dimensões / Dimensions / Dimensiones	mm	590x 695x 590
Dimensões Tabuleiros / Dim. Plateaux / Dim. Bandejas / Tray Dim.	mm	429x345x9
Capacidade Tabuleiros /Capac. Plateaux /Capaci. Bandejas /Chamber Capac.	nr	4
Espaço entre Prateleiras / Espace Étagères / Espacio Estantes / Shelves space	mm	74
Temperatura / Temperature / Temperatura / Temperature	°C	100-260
Peso Líquido - Bruto / Poids Net - Brut / Peso Net - Bruto / Net - Gross Weight	kg	33/38,8
Motor / Moteur / Motor / Motor	nr	1 Uni-dir.
Potência Total / Puissance Total / Potencia Total / Total Power	kW	2,8
Tensão / Tension / Tensión / Tension	V	230

Com Humidificador / Avec humidificateur / Con humidificador / With Humidifier



MODELO / MODÈLE / MODELO / MODEL	UDFCEMH423	
CÓDIGO / CODE / CÓDIGO / CODE	2106.105	
<b>Preço / Prix / Precio / Price</b>	<b>€</b>	<b>1.062,00</b>
Dimensões / Dimensions / Dimensiones	mm	590x 695x 590
Dimensões Tabuleiros / Dim. Plateaux / Dim. Bandejas / Tray Dim.	mm	429x345x9
Capacidade Tabuleiros /Capac. Plateaux /Capaci. Bandejas /Chamber Capac.	nr	4
Espaço entre Prateleiras / Espace Étagères / Espacio Estantes / Shelves space	mm	74
Temperatura / Temperature / Temperatura / Temperature	°C	100-260
Peso Líquido - Bruto / Poids Net - Brut / Peso Net - Bruto / Net - Gross Weight	kg	33,2/38
Motor / Moteur / Motor / Motor	nr	1 Uni-dir.
Potência Total / Puissance Total / Potencia Total / Total Power	kW	2,8
Tensão / Tension / Tensión / Tension	V	230

Com Humidificador / Avec humidificateur / Con humidificador / With Humidifier



MODELO / MODÈLE / MODELO / MODEL	UDFCEMM423	
CÓDIGO / CODE / CÓDIGO / CODE	2106.107	
<b>Preço / Prix / Precio / Price</b>	<b>€</b>	<b>1.240,00</b>
Dimensões / Dimensions / Dimensiones	mm	590x 695x 590
Dimensões Tabuleiros / Dim. Plateaux / Dim. Bandejas / Tray Dim.	mm	429x345x9
Capacidade Tabuleiros /Capac. Plateaux /Capaci. Bandejas /Chamber Capac.	nr	4
Espaço entre Prateleiras / Espace Étagères / Espacio Estantes / Shelves space	mm	74
Temperatura / Temperature / Temperatura / Temperature	°C	100-260
Peso Líquido - Bruto / Poids Net - Brut / Peso Net - Bruto / Net - Gross Weight	kg	36,4 / 41,4
Motor / Moteur / Motor / Motor	nr	1 Uni-dir.
Potência Total / Puissance Total / Potencia Total / Total Power	kW	2,6
Tensão / Tension / Tensión / Tension	V	230



OPCIONAL / OPTIONNEL / OPTATIVO / OPTIONAL

Cód.	Ref.	€
2106.210	1 x TABULEIRO ADICIONAL 429x345x9mm	49,00



confirmar disponibilidade  
confirmer la disponibilité  
confirmar la disponibilidad  
confirm the availability



UDI



**FORNOS - MECÂNICOS - UDF**  
FOURS COMBI - MÉCANIQUES - UDF  
HORNOS COMBI - MECÁNICO - UDF  
COMBI OVENS - MECHANICAL - UDF



Forno convetor eléctrico mecânico com ventilador e sem humidificador; Câmara de cozedura em aço inox AISI430; Porta basculante ventilada com vidro inspeccionável; Guarnição embutida; Temperatura controlada por termostato; Inclui 4 tabuleiros alumínio(429x345)

Four à convecteur électrique mécanique avec ventilateur et sans humidificateur; Chambre de cuisson en acier inoxydable AISI430; Porte battante ventilée avec verre inspecté; Garniture intégrée; Température contrôlée par thermostat; Comprend 4 plateaux en aluminium (429x345)

Horno convetor eléctrico mecánico con ventilador y sin humidificador; Cámara de cocción de acero inoxidable AISI430; Porta basculante ventilada com vidro inspeccionável; Embellecedor incorporado; Temperatura controlada por termostato; incluye 4 bandejas de aluminio (429x345)

Mechanical electric convector oven with fan and without humidifier; AISI430 stainless steel cooking chamber; tilt door with inspected glass; Built-in trim; Temperature controlled by thermostat; Includes 4 aluminum trays (429x345)

**NOVO**  
**NOUVEAU**  
**NUEVO**  
**NEW**



Sem Humidificador / Pas d'humidificateur / Sin humidificador / Without Humidifier			
MODELO / MODÈLE / MODELO / MODEL		UDFCEM423N	
CÓDIGO / CODE / CÓDIGO / CODE		2106.124	
<b>Preço / Prix / Precio / Price</b>	€	<b>971,00</b>	
Dimensões / Dimensions / Dimensiones	mm	590x709x589	
Capacidade Tabuleiros / Capacité plateaux / Capacidad bandejas / Tray Capacity	nr	4	
Espaço entre prateleiras / Espace étagères / Espacio entre estanterías / Shelves space	mm	74	
Temperatura / Temperature / Temperatura / Temperature	°C	100-260	
Peso Líquido - Bruto / Poids Net - Brut / Peso Net - Bruto / Net - Gross Weight	Kg	33-38,8	
Motor / Moteur / Motor / Motor	nr	1 Uni-dir.	
Potência Total / Puissance Total / Potencia Total / Total Power	kW	3,1	
Tensão / Tension / Tensión / Tension	V	230	

**NOVO**  
**NOUVEAU**  
**NUEVO**  
**NEW**



Com Humidificador / Avec humidificateur / Con humidificador / With Humidifier			
MODELO / MODÈLE / MODELO / MODEL		UDFCEMH423N	
CÓDIGO / CODE / CÓDIGO / CODE		2106.128	
<b>Preço / Prix / Precio / Price</b>	€	<b>1.062,00</b>	
Dimensões / Dimensions / Dimensiones	mm	590x709x589	
Capacidade Tabuleiros / Capacité plateaux / Capacidad bandejas / Tray Capacity	nr	4	
Espaço entre prateleiras / Espace étagères / Espacio entre estanterías / Shelves space	mm	74	
Temperatura / Temperature / Temperatura / Temperature	°C	100-260	
Peso Líquido - Bruto / Poids Net - Brut / Peso Net - Bruto / Net - Gross Weight	Kg	33-38,8	
Motor / Moteur / Motor / Motor	nr	1 Uni-dir.	
Potência Total / Puissance Total / Potencia Total / Total Power	kW	3,1	
Tensão / Tension / Tensión / Tension	V	230	

Multifunções

**NOVO**  
**NOUVEAU**  
**NUEVO**  
**NEW**



Com Humidificador / Avec humidificateur / Con humidificador / With Humidifier			
MODELO / MODÈLE / MODELO / MODEL		UDFCEMM423N	
CÓDIGO / CODE / CÓDIGO / CODE		2106.132	
<b>Preço / Prix / Precio / Price</b>	€	<b>1.240,00</b>	
Dimensões / Dimensions / Dimensiones	mm	590x709x589	
Capacidade Tabuleiros / Capacité plateaux / Capacidad bandejas / Tray Capacity	nr	4	
Espaço entre prateleiras / Espace étagères / Espacio entre estanterías / Shelves space	mm	74	
Temperatura / Temperature / Temperatura / Temperature	°C	100-260	
Peso Líquido - Bruto / Poids Net - Brut / Peso Net - Bruto / Net - Gross Weight	Kg	36,4-41,4	
Motor / Moteur / Motor / Motor	nr	1 Uni-dir.	
Potência Total / Puissance Total / Potencia Total / Total Power	kW	2,6	
Tensão / Tension / Tensión / Tension	V	230	



**4x**  
429x345x9mm

Tabuleiros Alumínio incluídos  
Plateaux Aluminium inclus  
Bandejas Aluminio incluidas  
Aluminum Trays included



OPCIONAL / OPTIONNEL / OPTATIVO / OPTIONAL

Cód.	Ref.	€
2106.210	1 x TABULEIRO ADICIONAL 429x345x9mm	<b>49,00</b>

**FP05 G - Gás- MEC**

Forno com ventilador e humidificador automático para uma distribuição controlada do ar; grelhas e tabuleiros não incluídos.

**FP05GA - Gás- ANA**

Forno com ventilador e humidificador automático para uma distribuição controlada do ar; grelhas e tabuleiros não incluídos.

**FDG55DG-Gás-ANA**

Forno com ventilador e humidificador automático para uma distribuição controlada do ar; 2 velocidades; com uma câmara cônica que garante a circulação do ar; grelhas e tabuleiros não incluídos.

**FP05 G - Gás- MEC**

Four avec ventilateur et humidificateur automatique pour une distribution contrôlée de l'air; grils et plateaux non inclus.

**FP05GA - Gás- ANA**

Four avec ventilateur et humidificateur automatique pour une distribution contrôlée de l'air; grils et plateaux non inclus.

**FDG55DG-Gás-ANA**

Four avec ventilateur et humidificateur automatique pour une libération contrôlée d'air; 2 vitesses; avec une chambre conique qui garantit la circulation de l'air; grils et plateaux non inclus.

**FP05 G - Gás- MEC**

Horno con ventilador y humidificador automático para una distribución controlada del aire; rejillas y bandejas no incluidas

**FP05GA - Gás- ANA**

Horno con ventilador y humidificador automático para una distribución controlada del aire; 2 velocidades; con una cámara cónica que garantiza la circulación del aire; rejillas y bandejas no incluidas.

**FDG55DG-Gás-ANA**

Horno con ventilador y humidificador automático para una distribución controlada del aire; 2 velocidades; con una cámara cónica que garantiza la circulación del aire; rejillas y bandejas no incluidas.

**FP05 G - Gás- MEC**

Oven with fan and automatic humidifier for controlled air distribution; grills and trays not included.

**FP05GA - Gás- ANA**

Oven with fan and automatic humidifier for controlled air distribution; grills and trays not included.

**FDG55DG-Gás-ANA**

Oven with fan and automatic humidifier for a controlled delivery of air; 2 speeds; with a conical chamber that guarantees air circulation; grills and trays not included.



MODELO / MODÈLE / MODELO / MODEL CÓDIGO / CODE / CÓDIGO / CODE		FP05 G - GÁS- MEC 2183.051
<b>Preço / Prix / Precio / Price</b>	€	<b>5.600,00</b>
Dimensões / Dimensions / Dimensiones	mm	920x820x725
Capacidade da câmara / Chambre capacite / Capacidad cámara / Chamber capacity	Gn` s	5x400x600
Potência Térmica Nominal/ Puissance Thermique Nominale/ Potência Térmica Nominal/ Nominal Thermal Power	kW/Kcal	0,43/9,5
Potência Total / Puissance Total / Potencia Total / Total Power	kW	-
Peso Líquido-Bruto /Poids Net-Brut /Peso Neto-Bruto /Net-Gross Weight	Kg	115
Tensão / Tension / Tensión / Tension	V	230



MODELO / MODÈLE / MODELO / MODEL CÓDIGO / CODE / CÓDIGO / CODE		FP05GA - GÁS- ANALOG 2183.052
<b>Preço / Prix / Precio / Price</b>	€	<b>6.100,00</b>
Dimensões / Dimensions / Dimensiones	mm	920x820x725
Capacidade da câmara / Chambre capacite / Capacidad cámara / Chamber capacity	Gn` s	5x400x600
Potência Térmica Nominal/ Puissance Thermique Nominale/ Potência Térmica Nominal/ Nominal Thermal Power	kW/Kcal	0,43/9,5
Potência Total / Puissance Total / Potencia Total / Total Power	kW	-
Peso Líquido-Bruto /Poids Net-Brut /Peso Neto-Bruto /Net-Gross Weight	Kg	115
Tensão / Tension / Tensión / Tension	V	230



MODELO / MODÈLE / MODELO / MODEL CÓDIGO / CODE / CÓDIGO / CODE		FDG55DG-GÁS- ANALOG 2183.320
<b>Preço / Prix / Precio / Price</b>	€	<b>9.896,00</b>
Dimensões / Dimensions / Dimensiones	mm	810x1150x800
Capacidade da câmara / Chambre capacite / Capacidad cámara / Chamber capacity	Gn` s	5x400x600
Potência Térmica Nominal/ Puissance Thermique Nominale/ Potência Térmica Nominal/ Nominal Thermal Power	kW/Kcal	-
Potência Total / Puissance Total / Potencia Total / Total Power	kW	10
Peso Líquido-Bruto /Poids Net-Brut /Peso Neto-Bruto /Net-Gross Weight	Kg	-
Tensão / Tension / Tensión / Tension	V	400



UDI

## FORNOS PADARIA - PASTELARIA - ELÉTRICOS - OPORTUNIDADES

FOURS PÂTISSERIE - BOULANGERIE - ÉLÉCTRIQUES - OPPORTUNITÉS

HORNOS - PANADERÍA - ELÉCTRICOS - OPORTUNIDADES

PASTRY AND BAKERY OVENS - ELECTRIC - OPPORTUNITIES



### FDE55 DG - ELE-ANA

Forno com ventilador e humidificador automático para uma distribuição controlada do ar; 2 velocidades; com uma câmara cônica que garante a circulação do ar; grelhas e tabuleiros não incluídos.

### DAPE 10PP/BPE 104P - ELETRON

Fornos de convecção de pastelaria; Versão P: equipado com comandos eletrónicos programáveis nos modelos (10) humidificação, iluminação interna e porta com vidro duplo.



### FDE55 DG - ELE-ANA

Four avec ventilateur et humidificateur automatique pour une libération contrôlée d'air; 2 vitesses; avec une chambre conique qui garantit la circulation de l'air; grills et plateaux non inclus.

### DAPE 10PP/BPE 104P - ELETRON

Fours à convection; Version P: équipée de commandes électroniques programmables dans les modèles (10) humidification, éclairage intérieur et double porte en verre.



### FDE55 DG - ELE-ANA

Horno con ventilador y humidificador automático para una distribución controlada del aire; 2 velocidades; con una cámara cónica que garantiza la circulación del aire; rejillas y bandejas no incluidas.

### DAPE 10PP/BPE 104P - ELETRON

Hornos de pastelería de convección; Versión P: equipado con mandos electrónicos programables en los modelos (10) humidificación, iluminación interna y puerta con doble cristal.



### FDE55 DG - ELE-ANA

Oven with fan and automatic humidifier for a controlled delivery of air; 2 speeds; with a conical chamber that guarantees air circulation; grills and trays not included.

### DAPE 10PP/BPE 104P - ELETRON

Pastry convection ovens; Version P: equipped with programmable electronic controls in the models (10) humidification, indoor lighting and double glass door.



MODELO / MODÈLE / MODELO / MODEL	FOR.CONV.FC 110 EG C/G.C/HUM.P/4	
CÓDIGO / CODE / CÓDIGO / CODE	2230.080	
<b>Preço / Prix / Precio / Price</b>	€	<b>3.196,00</b>
Dimensões / Dimensions / Dimensiones	mm	795x720x600
Capacidade da câmara / Chambre capacite / Capacidad cámara / Chamber capacity	Gn`s	4x 600x400
Espaço entre as prateleiras / Espace entre étagères / Espacio entre las estanterías / Space between shelves	mm	-
Potência Total / Puissance Total / Potencia Total / Total Power	kW	5+2,8
Peso Líquido-Bruto / Poids Net-Brut / Peso Neto-Bruto / Net-Gross Weight	Kg	51
Tensão / Tension / Tensión / Tension	V	400



MODELO / MODÈLE / MODELO / MODEL	FDE55 DG - ELE ANALOG	
CÓDIGO / CODE / CÓDIGO / CODE	2183.310	
<b>Preço / Prix / Precio / Price</b>	€	<b>7.863,00</b>
Dimensões / Dimensions / Dimensiones	mm	810x1150x800
Capacidade da câmara / Chambre capacite / Capacidad cámara / Chamber capacity	Gn`s	5x400*600
Espaço entre as prateleiras / Espace entre étagères / Espacio entre las estanterías / Space between shelves	mm	-
Potência Total / Puissance Total / Potencia Total / Total Power	kW	7,5
Peso Líquido-Bruto / Poids Net-Brut / Peso Neto-Bruto / Net-Gross Weight	Kg	-
Tensão / Tension / Tensión / Tension	V	400



MODELO / MODÈLE / MODELO / MODEL	DAPE 10PP/BPE 104P - ELETRON	
CÓDIGO / CODE / CÓDIGO / CODE	2128.841	
<b>Preço / Prix / Precio / Price</b>	€	<b>10.099,00</b>
Dimensões / Dimensions / Dimensiones	mm	950x850x1010
Capacidade da câmara / Chambre capacite / Capacidad cámara / Chamber capacity	Gn`s	10x 600x400
Espaço entre as prateleiras / Espace entre étagères / Espacio entre las estanterías / Space between shelves	mm	72
Potência Total / Puissance Total / Potencia Total / Total Power	kW	16
Peso Líquido-Bruto / Poids Net-Brut / Peso Neto-Bruto / Net-Gross Weight	Kg	158
Tensão / Tension / Tensión / Tension	V	400

TABULEIROS PADARIA PASTELARIA / PLATEAUX-BOULANGERIE-PÂTISSERIE / BANDEJAS-PANADERÍA-PASTELERÍA / TRAYS-BAKERY AND PASTRY- 366>367



confirmar disponibilidade  
confirmer la disponibilité  
confirmar la disponibilidad  
confirm the availability

**FORNOS CONVECTORES  
ELETROMECÂNICOS**

Versão M : Ventilados; Câmara de cozedura em aço inox AISI430; Controlo de temperatura por termóstato; seleção temporizador; iluminação e função descongelação;

**UDFCEM464 4T:** Sem Humidificador  
**UDFCEMHG464:** Com Humidificador + Grill

**FOURS À CONVECTION  
ÉLECTROMÉCANIQUE**

Version M : Ventilés; Chambre en AISI430 en acier inoxydable de cuisson; Contrôle de la température par thermostat; Sélection de temporisateur; Éclairage et fonction de décongélation ;

**UDFCEM464 4T:** Sans Humidificateur  
**UDFCEMHG464:** Humidificateur + Grill

**HORNOS CONVECTORES  
ELECTROMECÁNICOS**

Versión M : Ventilados; Cámara de cocción en AISI430 de acero inoxidable; Control de la temperatura por termostato; Selección del temporizador; Iluminación y función descongelación;

**UDFCEM464 4T:** Sin humidificador  
**UDFCEMHG464:** con humidificador + Grill

**ELECTROMECHANICAL CONVECTION  
OVENS**

**M Version:** Ventilated; Cooking chamber in stainless steel AISI430; Thermostatically temperature control; Timer selection; lighting and defrost function;

**UDFCEMH64 4T:** Without Humidifier  
**UDFCEMHG464:** with Humidifier + Grill



Sem Humidificador / Pas d'humidificateur / Sin humidificador / Without Humidifier



MODELO / MODÈLE / MODELO / MODEL	UDFCEM464
CÓDIGO / CODE / CÓDIGO / CODE	2106.110
<b>Preço / Prix / Precio / Price</b>	€ <b>1.969,00</b>
Dimensões / Dimensions / Dimensiones	mm 784x774x634
Dimensões Tabuleiros / Dim. Plateaux / Dim. Bandejas / Tray Dim.	mm 600x400x20
Capacidade Tabuleiros /Capac. Plateaux /Capaci. Bandejas /Chamber Capac.	mm 4
Espaço entre Prateleiras / Espace Étagères / Espacio Estantes / Shelves space	nr 83
Temperatura / Temperature / Temperatura / Temperature	°C 100-260
Peso Líquido - Bruto / Poids Net - Brut / Peso Net - Bruto / Net - Gross Weight	kg 51,2 / 61,4
Motor / Moteur / Motor / Motor	nr 1Bi-dir.
Potência Total / Puissance Total / Potencia Total / Total Power	kW 6,2
Tensão / Tension / Tensión / Tension	V 400

Com Humidificador / Avec humidificateur / Con humidificador / With Humidifier



MODELO / MODÈLE / MODELO / MODEL	UDFCEMH464
CÓDIGO / CODE / CÓDIGO / CODE	2106.111
<b>Preço / Prix / Precio / Price</b>	€ <b>2.184,00</b>
Dimensões / Dimensions / Dimensiones	mm 784x752x634
Dimensões Tabuleiros / Dim. Plateaux / Dim. Bandejas / Tray Dim.	mm 600x400x20
Capacidade Tabuleiros /Capac. Plateaux /Capaci. Bandejas /Chamber Capac.	mm 4
Espaço entre Prateleiras / Espace Étagères / Espacio Estantes / Shelves space	nr 70
Temperatura / Temperature / Temperatura / Temperature	°C 100-260
Peso Líquido - Bruto / Poids Net - Brut / Peso Net - Bruto / Net - Gross Weight	kg 50,4/60,6
Motor / Moteur / Motor / Motor	nr 2 Uni-dir.
Potência Total / Puissance Total / Potencia Total / Total Power	kW 3,4
Tensão / Tension / Tensión / Tension	V 230

Com Humidificador / Avec humidificateur / Con humidificador / With Humidifier



Grill



MODELO / MODÈLE / MODELO / MODEL	UDFCEMHG464
CÓDIGO / CODE / CÓDIGO / CODE	2106.112
<b>Preço / Prix / Precio / Price</b>	€ <b>2.470,00</b>
Dimensões / Dimensions / Dimensiones	mm 784x752x634
Dimensões Tabuleiros / Dim. Plateaux / Dim. Bandejas / Tray Dim.	mm 600x400x20
Capacidade Tabuleiros /Capac. Plateaux /Capaci. Bandejas /Chamber Capac.	mm 4
Espaço entre Prateleiras / Espace Étagères / Espacio Estantes / Shelves space	nr 83
Temperatura / Temperature / Temperatura / Temperature	°C 100-260
Peso Líquido - Bruto / Poids Net - Brut / Peso Net - Bruto / Net - Gross Weight	kg 52/62,2
Motor / Moteur / Motor / Motor	nr 2 Uni-dir.
Potência Total / Puissance Total / Potencia Total / Total Power	kW 5,2
Tensão / Tension / Tensión / Tension	V 400



opcional  
optionnel  
opcional  
optional

**Tabuleiros não incluídos**  
Plateaux non inclus  
Bandejas no incluidas  
Trays not included



confirmar disponibilidade  
confirmer la disponibilité  
confirmar la disponibilidad  
confirm the availability





UDI

**FORNOS - MECÂNICOS - UDF**  
FOURS COMBI - MÉCANIQUES - UDF  
HORNOS COMBI - MECÁNICO - UDF  
COMBI OVENS - MECHANICAL - UDF



Forno convetor eléctrico mecânico; Câmara de cozedura em aço inox AISI430; Porta basculante ventilada com vidro inspecionável; Guarnição embutida; Temperatura controlada por termostato; Capacidade para 4 tabuleiros alumínio(40x60); Concebido para acompanhar o trabalho diário de restaurantes e snack-bars de média dimensão.



Four à convection électrique mécanique ; Chambre de cuisson en acier inoxydable AISI430 ; Porte battante ventilée avec vitre d'inspection haute; garniture farcie; Température contrôlée par thermostat ; Capacité pour 4 tabuleiros en aluminium (40x60); Conçu pour accompagner le travail quotidien des restaurants et snack-bars de taille moyenne.



Horno de convector eléctrico mecânico; cámara de cocción de acero inoxidable AISI430; Puerta batiente ventilada con vidrio inspeccionable; Embellecedor incorporado; Temperatura controlada por termostato; Capacidad para 4 bandejas de aluminio (40x60); Diseñado para acompañar el trabajo diario de restaurantes y cafeterías de tamaño medio.



Mechanical electric convector oven; Cooking chamber in AISI430 stainless steel; Ventilated swing door with high inspection glass; stuffed garnish; Thermostat controlled temperature; Capacity for 4 aluminum tabuleiros (40x60); Conceived to accompany the daily work of medium-sized restaurants and snack bars.

**4x**  
600x400mm

**NOVO**  
NOUVEAU  
NUEVO  
NEW



**Sem** Humidificador / **Pas** d'humidificateur / **Sin** humidificador / **Without** Humidifier



MODELO / MODÈLE / MODELO / MODEL	UDFCEM464N	
CÓDIGO / CODE / CÓDIGO / CODE	2106.134	
<b>Preço / Prix / Precio / Price</b>	€	<b>1.969,00</b>
Dimensões / Dimensions / Dimensiones	mm	784x777x634
Capacidade Tabuleiros / Capacité plateaux / Capacidad bandejas / Tray Capacity	nr	4
Espaço entre prateleiras / Espace étagères / Espacio entre estanterías / Shelves space	mm	83
Temperatura / Temperature / Temperatura / Temperature	°C	100-260
Peso Líquido - Bruto / Poids Net - Brut / Peso Net - Bruto / Net - Gross Weight	kg	51,2-61,4
Motor / Moteur / Motor / Motor	nr	1 Bi. dir.
Potência Total / Puissance Total / Potencia Total / Total Power	kW	6,2
Tensão / Tension / Tensión / Tension	V	400

**4x**  
600x400mm

**NOVO**  
NOUVEAU  
NUEVO  
NEW



**Com** Humidificador / **Avec** humidificateur / **Con** humidificador / **With** Humidifier



MODELO / MODÈLE / MODELO / MODEL	UDFCEMH464N	
CÓDIGO / CODE / CÓDIGO / CODE	2106.138	
<b>Preço / Prix / Precio / Price</b>	€	<b>2.184,00</b>
Dimensões / Dimensions / Dimensiones	mm	784x752x634
Capacidade Tabuleiros / Capacité plateaux / Capacidad bandejas / Tray Capacity	nr	4
Espaço entre prateleiras / Espace étagères / Espacio entre estanterías / Shelves space	mm	73
Temperatura / Temperature / Temperatura / Temperature	°C	100-260
Peso Líquido - Bruto / Poids Net - Brut / Peso Net - Bruto / Net - Gross Weight	kg	50,4-60,6
Motor / Moteur / Motor / Motor	nr	2 Uni-dir.
Potência Total / Puissance Total / Potencia Total / Total Power	kW	3,4
Tensão / Tension / Tensión / Tension	V	230

**4x**  
600x400mm

**NOVO**  
NOUVEAU  
NUEVO  
NEW



**Com** Humidificador / **Avec** humidificateur / **Con** humidificador / **With** Humidifier



MODELO / MODÈLE / MODELO / MODEL	UDFCEMHG464N	
CÓDIGO / CODE / CÓDIGO / CODE	2106.142	
<b>Preço / Prix / Precio / Price</b>	€	<b>2.700,00</b>
Dimensões / Dimensions / Dimensiones	mm	784x752x634
Capacidade Tabuleiros / Capacité plateaux / Capacidad bandejas / Tray Capacity	nr	4
Espaço entre prateleiras / Espace étagères / Espacio entre estanterías / Shelves space	mm	83
Temperatura / Temperature / Temperatura / Temperature	°C	100-260
Peso Líquido - Bruto / Poids Net - Brut / Peso Net - Bruto / Net - Gross Weight	kg	52-62,2
Motor / Moteur / Motor / Motor	nr	2 Uni-dir.
Potência Total / Puissance Total / Potencia Total / Total Power	kW	5,2
Tensão / Tension / Tensión / Tension	V	400

**Grill**



opcional  
optionnel  
opcional  
optional

**Tabuleiros não incluídos**  
Plateaux non inclus  
Bandejas no incluidas  
Trays not included



OPCIONAIS UDF / OPTIONNELLES UDF / OPCIONALES UDF / UDF OPTIONALS 274>275

Consulte condições na pág. 6 • Voir conditions dans la page 6 • Ver condiciones en la pág. 6 • Conditions on page 6



Câmara de cozedura em aço inox AISI430  
Painel de Controlo Eletromecânico  
Controlo de temperatura por termostato.



Chambre de cuisson en acier inox AISI 430  
Panneau de configuration électromécanique  
Contrôle de la température par thermostat



Cámara de cocción en acero inoxidable AISI 430  
Panel de control electromecánico  
Control de la temperatura mediante termostato



Stainless steel AISI 430 cooking chamber  
Electromechanical Control Panel  
Temperature control by thermostat



UDEAPT823  
429X345  
2106.204



UDEAPT864  
8T.  
600X400  
2106.200



**GRELHA CROMADO**  
435X340

2106.212

21,00

MODELO / MODÈLE / MODELO / MODEL	UDEAPT823 429X345	UDEAPT864 8T. 600X400
CÓDIGO / CODE / CÓDIGO / CODE	2106.204	2106.200
<b>Preço / Prix / Precio / Price</b>	<b>€ 1.118,00</b>	<b>1.904,00</b>
Dimensões / Dimensions / Dimensiones	mm 595x545x840	795x655x835
Dimensões Tabuleiros / Dim. Plateaux / Dim. Bandejas / Tray Dim.	mm 429x345	600x400
Capacidade Tabuleiros /Capac. Plateaux /Capaci. Bandejas /Chamber Capac.	mm 8	8
Espaço entre Prateleiras / Espace Étagères / Espacio Estantes / Shelves space	mm 74	70
Temperatura / Temperature / Temperatura / Temperature	°C 30/60	30/60
Peso Líquido - Bruto / Poids Net - Brut / Peso Net - Bruto / Net - Gross Weight	kg 25,8 / -	43,6
Potência Total / Puissance Total / Potencia Total / Total Power	kW 1,2	2,4
Tensão / Tension / Tensión / Tension	V 230	230



UDI

**FORNOS PADARIA - PASTELARIA - UDF**  
FOURS PÂTISSERIE - BOULANGERIE - UDF  
HORNOS - PANADERÍA - UDF  
PASTRY AND BAKERY OVENS - UDF



VAPOR DIRETO | VAPEUR DIRECTE | VAPOR DIRECTO | DIRECT STEAM



Forno carregado vapor direto para 16 tabuleiros 600x400mm com painel tátil "TOUCH SCREEN"  
Equipado de serie: 500 programas com 10 fases de cozedura (possíveis)  
Controlo de temperatura 2 sondas digitais  
Função pré-aquecimento a 180 °C  
Sistema automático de lavagem incluído  
4 ventiladores bidirecionais para cozedura uniforme  
Carro extraível com pega e dotado de rodas com travões  
Porta batente com abertura ajustável : 60 °, 90°, 120°, 180°  
Porta USB



Four vapeur directe avec chariot pour 16 plateaux 600x400mm avec écran tactile « TOUCH SCREEN »  
Equipé de série : 500 programmes avec 10 étapes de cuisson (possible)  
Contrôle de température 2 sondes digital  
Fonction de préchauffage à 180 °C  
Système de lavage automatique inclus  
4 ventilateurs bidirectionnels pour une cuisson uniforme  
Chariot amovible avec poignée et roues avec freins  
Porte battante avec ouverture réglable : 60°, 90°, 120°, 180°  
Port USB



Horno carregado de vapor directo para 16 bandejas 600x400mm con panel tátil "TOUCH SCREEN"  
Equipado de serie: 500 programas con 10 etapas de cocción (posible)  
Control de temperatura 2 sondas digitales  
Función de precalentamiento a 180 °C  
Sistema de lavado automático incluído  
4 ventiladores bidireccionales para una cocción uniforme  
Coche desmontable con asa y ruedas con freno.  
Puerta batiente con apertura regulable: 60°, 90°, 120°, 180°  
Puerto USB



Direct steam oven with trolley for 16 trays 600x400mm with touch panel "TOUCH SCREEN"  
Standard equipped: 500 programs with 10 cooking steps (possible)  
Temperature control 2 digital probes  
Pre-heating function at 180 °C  
Automatic washing system included  
4 bidirectional fans for uniform cooking  
Removable trolley removable handle and braked wheels  
Hinged door with locking for openings adjusted : 60°, 90°, 120°, 180°  
USB port



UDFTSE1664  
2106.658



UDFTSG1664  
2106.660



MODELO / MODÈLE / MODELO / MODEL	UDFTSE1664	UDFTSG1664
CÓDIGO / CODE / CÓDIGO / CODE	2106.658	2106.660
<b>Preço / Prix / Precio / Price</b>	€ <b>22.734,00</b>	<b>24.978,00</b>
Dimensões / Dimensions / Dimensiones	mm 930x1035x1900	930x1160x2060
Capacidade Tabuleiros / Capacité plateaux / Capacidad bandejas / Tray Capacity	nr 600x400x16	600x400x16
Espaço entre prateleiras / Espace étagères / Espacio entre estanterías / Shelves space	mm 80	80
Temperatura / Temperature / Temperatura / Temperature	°C 30 - 270	30 - 260
Peso Líquido - Bruto / Poids Net - Brut / Peso Net - Bruto / Net - Gross Weight	kg 247,2	277,2
Motor / Moteur / Motor / Motor	nr 4 bi-dir.	4 bi-dir.
Potência Total / Puissance Total / Potencia Total / Total Power	kW 31	30
Tensão / Tension / Tensión / Tension	V 400	230

TABULEIROS PADARIA PASTELARIA / PLATEAUX-BOULANGERIE-PÂTISSERIE / BANDEJAS-PANADERÍA-PASTELERÍA / TRAYS-BAKERY AND PASTRY- 366>367





Painel de comando eletromecânico com indicadores de controlo de funcionamento.  
 3 Modos de funcionamento: convecção (50°C - 260°C); vapor (50°C - 130°C); combinado (50°C - 260°C).  
 Sistema Autoreverse (Inversão automática do sentido da rotação do ventilador).  
 Ventilação manual da câmara.  
 Iluminação interna LED.  
 Porta com vidro duplo temperado termoreflético com cavidade de ar para evitar a radiação de calor para o utilizador e aumentar eficiência.  
 Sistema de limpeza manual com chuveiro de mão externo (chuveiro opcional).



Électromécanique panneau de commande avec des indicateurs de contrôle de fonctionnement.  
 3 Modes de cuisson: convection (50°C - 260°C); vapeur (50°C - 130°C); combiné (50°C - 260°C).  
 Système Autoreverse (inversion automatique du sens de rotation du ventilateur).  
 Ventilation manuelle de la chambre LED éclairage intérieur.  
 Porte à double vitrage avec verre trempé thermoréfléchissant avec cavité d'air pour empêcher le rayonnement de chaleur vers les utilisateurs et une efficacité accrue.  
 Système de nettoyage manuel avec douche à main externe (douche en option).



Panel de control electromecánico con indicadores de control de funcionamiento.  
 3 modos de cocción: convección (50°C - 260°C); vapor 50°C - 130°C; combinado (50°C - 260°C).  
 Sistema de Autoreverse (inversión automática del sentido de rotación del ventilador).  
 Cámara de ventilación manual LED de iluminación interior.  
 Puerta de doble cristal templado termorefléctante con cavidad d'aire para evitar la radacion de calor hacia los usuarios y mayor eficiencia.  
 Sistema de limpieza manual con ducha de mano externa (ducha opcional).



Painel de comando eletromecânico com indicadores de controlo de funcionamento.  
 3 Modos de funcionamento: convecção (50°C - 260°C); vapor (50°C - 130°C); combinado (50°C - 260°C).  
 Sistema Autoreverse (Inversão automática do sentido da rotação do ventilador).  
 Ventilação manual da câmara.  
 Iluminação interna LED.  
 Porta com vidro duplo temperado termoreflético com cavidade de ar para evitar a radiação de calor para o utilizador e aumentar eficiência.  
 Sistema de limpeza manual com chuveiro de mão externo (chuveiro opcional).



MODELO / MODÈLE / MODELO / MODEL	ICEM 051E
CÓDIGO / CODE / CÓDIGO / CODE	4001.108
<b>Preço / Prix / Precio / Price</b>	<b>€ 5.176,00</b>
Dimensões / Dimensions / Dimensiones	mm 777x729x777
Capacidade da câmara / Chambre capacite / Capacidad cámara / Chamber capacity	nr 4x 600x400
Espaço entre as prateleiras / Espace entre etâgeres / Espacio entre las estanterías / Space between shelves	mm 90
Peso Líquido-Bruto / Poids Net-Brut / Peso Neto-Bruto / Net-Gross Weight	kg 74/85
Potência Total / Puissance Total / Potencia Total / Total Power	kW 7,25
Tensão / Tension / Tensión / Tension	V 400



MODELO / MODÈLE / MODELO / MODEL	ICEM 071E
CÓDIGO / CODE / CÓDIGO / CODE	4001.112
<b>Preço / Prix / Precio / Price</b>	<b>€ 6.750,00</b>
Dimensões / Dimensions / Dimensiones	mm 777x729x942
Capacidade da câmara / Chambre capacite / Capacidad cámara / Chamber capacity	nr 6x 600x400
Espaço entre as prateleiras / Espace entre etâgeres / Espacio entre las estanterías / Space between shelves	mm 90
Peso Líquido-Bruto / Poids Net-Brut / Peso Neto-Bruto / Net-Gross Weight	kg 90/102
Potência Total / Puissance Total / Potencia Total / Total Power	kW 12,5
Tensão / Tension / Tensión / Tension	V 400



MODELO / MODÈLE / MODELO / MODEL	ICEM 101
CÓDIGO / CODE / CÓDIGO / CODE	4001.116
<b>Preço / Prix / Precio / Price</b>	<b>€ 7.734,00</b>
Dimensões / Dimensions / Dimensiones	mm 777x729x1152
Capacidade da câmara / Chambre capacite / Capacidad cámara / Chamber capacity	nr 8x 600x400
Espaço entre as prateleiras / Espace entre etâgeres / Espacio entre las estanterías / Space between shelves	mm 90
Peso Líquido-Bruto / Poids Net-Brut / Peso Neto-Bruto / Net-Gross Weight	kg 104/117
Potência Total / Puissance Total / Potencia Total / Total Power	kW 14,5
Tensão / Tension / Tensión / Tension	V 400



sob pedido  
sur demande  
a pedido  
on request

**FORNOS ROTATIVOS - PADARIA - PASTELARIA**

FOURS ROTATIFS - BOULANGERIE - PÂTISSERIE

HORNOS GIRATÓRIOS - PANADERÍA - PASTELERÍA

BAKERY AND PASTRY ROTARY OVEN



MINI COMBO



QUEIMADOR  
GAS

QUEIMADOR  
GASOLEO

Os fornos gás / gasóleo não incluem queimadores  
Fours à gaz / diesel ne comprennent pas les brûleurs  
Hornos de gas / diesel no incluyen quemadores  
Burners aren't included in gas / diesel

Câmara de fermentação  
Chambre de fermentation  
Cámara de fermentación  
Heating-leavening chamber

CAMARA FERMENTAÇÃO 40X60

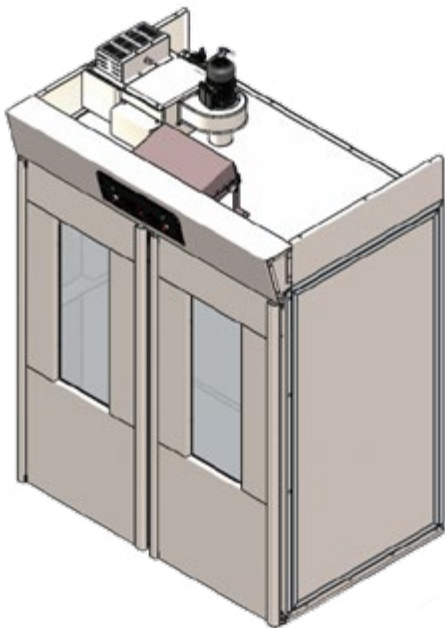

CAMARA  
FERMENTAÇÃO



CAMARA  
FERMENTAÇÃO



elétrico  
électrique  
eléctrico  
electric



gás  
gaz  
gas  
gas



opcional  
optionnel  
opcional  
optional

**TABULEIROS E GRELHAS | PLATEAUX ET GRILLES | BANDEJAS Y REJILLAS | TRAYS AND GRIDS - MOD UD**

Cód.	Ref.	€
2051.076	TABULEIRO ONDULADO ALUMÍNIO FURADO 60x40 SEM REVESTIMENTO SPECA	65,00
2051.078	TABULEIRO ONDULADO ALUMÍNIO FURADO 60x40 COM REVESTIMENTO SILICONE 5P	81,00
2051.080	TABULEIRO ONDULADO ALUMÍNIO FURADO 60x40 COM REVESTIMENTO ELASTÓMERO 5P	94,00
2051.086	TABULEIRO ONDULADO ALUMÍNIO FURADO 75x45 SEM REVESTIMENTO 5PE	103,00
2051.090	TABULEIRO ONDULADO ALUMÍNIO FURADO 75x45 COM REVESTIMENTO ELASTÓMERO 5P	112,00
2051.096	TABULEIRO ONDULADO ALUMÍNIO FURADO 80x60 COM REVESTIMENTO SILICONE 8P	128,00
2051.098	TABULEIRO ONDULADO ALUMÍNIO FURADO 80x60 COM REVESTIMENTO ELASTÓMERO 8P	140,00
2051.102	TABULEIRO ONDULADO ALUMÍNIO FURADO 60x40 COM REVESTIMENTO SILICONE 8P	72,00
2051.104	TABULEIRO ONDULADO ALUMÍNIO FURADO 60x40 COM REVESTIMENTO ELASTÓMERO 8P	91,00

**Tabuleiro em alumínio com abas**

Plateau plat en aluminium

Bandeja de aluminio plana

Flat aluminium baking tray

Cód.	Ref.	€
2051.106	TABULEIRO PLANO AÇO INOX 60x40x4	94,00
2051.107	TABULEIRO AÇO INOX 60x40x10	112,00
2051.110	TABULEIRO PLANO AÇO INOX 75x45x4	186,00
2051.112	TABULEIRO PLANO AÇO INOX 80x40x4	84,00
2051.120	TABULEIRO 45x75 COM ELASTÓMERO FURADO REFORÇADO	120,00
2051.122	TABULEIRO 45x75 COM SILICONE TRANSP. FURADO REFORÇADO	81,00

**Tabuleiro de chapa**

Plateau de tôle

Bandeja de chapa

Steel baking tray

Cód.	Ref.	€
2051.002	TABULEIRO PLANO CHAPA 60x40x2 ESTAMPADO	24,00
2051.004	TABULEIRO PLANO CHAPA 70x50x2	44,00
2051.006	TABULEIRO PLANO CHAPA 75x45x2	39,00
2051.007	TABULEIRO PLANO CHAPA DE FERRO 77x40x2	34,00
2051.008	TABULEIRO PLANO CHAPA 80x40x2	39,00
2051.010	TABULEIRO PLANO CHAPA 80x60x2	44,00

**Tabuleiro em alumínio com abas**

Plateau en aluminium avec cadre

Bandeja de aluminio con marco

Aluminium baking tray with frame

Cód.	Ref.	€
2051.012	TABULEIRO PLANO ALUMÍNIO 60x40x2 SEM REVESTIMENTO	44,00
2051.014	TABULEIRO PLANO ALUMÍNIO 60x40x4 SEM REVESTIMENTO	59,00
2051.016	TABULEIRO PLANO ALUMÍNIO 60x40x2 COM REVESTIMENTO SILICONE	48,00
2051.018	TABULEIRO PLANO ALUMÍNIO 60x40x4 COM REVESTIMENTO SILICONE	74,00
2051.022	TABULEIRO PLANO ALUMÍNIO 75x45x2 COM REVESTIMENTO SILICONE	72,00
2051.023	TABULEIRO PLANO ALUMÍNIO 75x45x2 SEM REVESTIMENTO	62,00
2051.024	TABULEIRO PLANO ALUMÍNIO 75x45x4 COM REVESTIMENTO SILICONE	87,00



confirmar disponibilidade  
 confirmer la disponibilité  
 confirmar la disponibilidad  
 confirm the availability



UDI

**PADARIA - PASTELARIA - ACESSÓRIOS E OPCIONAIS**  
 BOULANGERIE - PÂTISSERIE - ACCESSOIRES ET OPTIONNELS  
 PANADERÍA - PASTELERÍA - ACCESORIOS Y OPCIONALES  
 BAKERY AND PASTRY - OPTIONALS AND SPARE PARTS



**TABULEIROS | PLATEAUX | BANDEJAS | TRAYS**



**Tabuleiro em alumínio furado sem abas com reforço lateral**

Plateau en aluminium perforé sans bords avec latéral renforcé  
 Bandeja de aluminio perforado sin bordes con refuerzos laterales  
 Aluminium baking tray with 2 ribbed sides

Cód.	Ref.	€
2051.034	TABULEIRO PLANO ALUMÍNIO FURADO 60x40 COM REVESTIMENTO ELASTÓMERO	65,00
2051.057	TABULEIRO PLANO ALUMÍNIO FURADO 60x80 SEM REVESTIMENTO	65,00
2051.038	TABULEIRO PLANO ALUMÍNIO FURADO 75x45 COM REVESTIMENTO ELASTÓMERO	91,00



**Tabuleiro em alumínio com abas de 2 cm estampado**

Plateau plat en aluminum avec cadre de 2 cm moulé  
 Bandeja de aluminio plana con marco de 2 cm moldeado  
 Flat aluminium baking tray with 2 cm moulded frame

Cód.	Ref.	€
2051.040	TABULEIRO PLANO ALUMÍNIO 60x40x2 LISO SEM REVESTIMENTO	35,00
2051.042	TABULEIRO PLANO ALUMÍNIO 60x40x2 LISO COM REVESTIMENTO SILICONE	41,00
2051.044	TABULEIRO PLANO ALUMÍNIO 60x40x2 LISO COM REVESTIMENTO ELASTÓMERO	67,00
2051.046	TABULEIRO PLANO ALUMÍNIO 60x40x2 FURADO SEM REVESTIMENTO	47,00
2051.050	TABULEIRO PLANO ALUMÍNIO 60x40x2 FURADO COM REVESTIMENTO TEFLON	87,00
2051.052	TABULEIRO PLANO ALUMÍNIO 60x40x2 FURADO SEM REVESTIMENTO	52,00



**Tabuleiro em alumínio com abas de 2 cm estampado**

Plateau plat en aluminum avec cadre de 2 cm moulé  
 Bandeja de aluminio plana con marco de 2 cm moldeado  
 Flat aluminium baking tray with 2 cm moulded frame

Cód.	Ref.	€
2051.056	TABULEIRO PLANO ALUMÍNIO 60x40x2 FURADO COM REVESTIMENTO ELASTÓMERO	70,00
2051.064	TABULEIRO PLANO ALUMÍNIO 75x45x2 FURADO COM REVESTIMENTO SILICONE	59,00
2051.066	TABULEIRO PLANO ALUMÍNIO 75x45x2 FURADO COM REVESTIMENTO ELASTÓMERO	88,00



# PRODUTORES DE GELO

GAMA DISPONÍVEL  
NO WEBSITE  
PRODUCT LINE AVAILABLE ON  
THE WEBSITE



## FABRICADOS COM AS TECNOLOGIAS MAIS AVANÇADAS

Comercializamos máquinas de gelo de acordo com os mais altos padrões da indústria. O portfólio que dispomos resulta de um esforço e pesquisa constantes, a fim de entender e antecipar os desenvolvimentos do mercado e produzir gamas de produtos constantemente atualizadas e competitivas.

### ICE MAKERS

MANUFACTURED WITH THE MOST ADVANCED TECHNOLOGIES

We commercialize ice machines in accordance with the highest industry standards. The portfolio that we possess stems from constant effort and research, in order to understand and anticipate developments in the market and produce product lines that are competitive and constantly updated.





**FRIO**  
FROID  
FRÍO  
COLD





Em menos de 10 minutos, o gelo estará pronto e cairá na cuba removível de 1,6 kg. Pode optar por ligar a torneira de água, assim terá sempre o tanque de 2,8 L cheio, ou pode enchê-lo manualmente. Graças à sua produção diária de 15 kg de gelo, nunca mais ficará sem gelo! Pode escolher entre 2 tamanhos de gelo.



En moins de 10 minutes, la glace sera prête et tombera dans le bac amovible de 1,6 kg. Vous pouvez décider de le fixer au robinet d'eau, de cette façon vous aurez toujours le réservoir de 2,8 L plein, ou vous pourrez le remplir manuellement. Grâce à sa production quotidienne de 15 kg de glace, vous ne manquerez plus jamais de glace! Vous pouvez choisir entre 2 tailles de glace.



En menos de 10 minutos el hielo estará listo y caerá en la cuba extraíble de 1,6 kg. Puedes decidir acoplarlo al grifo del agua, de esta forma siempre tendrás lleno el depósito de 2,8 L, o puedes llenarlo manualmente. Gracias a su producción diaria de 15 kg de hielo, nunca más te quedarás sin hielo! Puedes elegir entre 2 tamaños de hielo.



In less than 10 minutes, the ice will be ready and fall into the removable 1.6 kg tub. You can choose to turn on the water tap, so you'll always have a full 2.8 L tank, or you can fill it manually. Thanks to its daily production of 15 kg of ice, you'll never run out of ice again! You can choose from 2 ice sizes.



**NOVO  
NOUVEAU  
NUEVO  
NEW**



MODELO / MODÈLE / MODELO / MODEL	PROFISSIONAL 15 KG
CÓDIGO / CODE / CÓDIGO / CODE	2230.916
<b>Preço / Prix / Precio / Price</b>	<b>€ 445,00</b>
Dimensões / Dimensions / Dimensiones	mm 395x244x430
Produção de gelo / Production glaçon / Producción de hielo/ Ice production	kg/24h 15
Cap. Depósito / Cap. dépôt / Cap. deposito / Deposit capacity	kg 1,6
Peso Líquido-Bruto / Poids Net-Brut / Peso Neto-Bruto / Net-Gross Weight	kg 21,5-24
Potência / Puissance / Potência / Power	W 145
Tensão / Tension / Tension / Tension	V 230

**MÁQUINAS DE GELO EM CUBOS SEM LIGAÇÃO À REDE**
**MACHINES À GLAÇON EN CUBE SANS CONNEXION RÉSEAU**
**FABRICADORES DE HIELO SIN CONÉXION À LA RED**
**ICE CUBE MAKERS WITH NO NETWORK CONNECTION**

MODELO / MODÈLE / MODELO / MODEL	LCD 15 KE
CÓDIGO / CODE / CÓDIGO / CODE	2828.790
<b>Preço / Prix / Precio / Price</b>	<b>€ 396,00</b>
Dimensões / Dimensions / Dimensiones	mm 360x440x450
Produção de gelo / Production glaçon / Producción de hielo/ Ice production	kg/24h 15
Cap. Depósito / Cap. dépôt / Cap. deposito / Deposit capacity	kg 4,5
Peso Líquido-Bruto / Poids Net-Brut / Peso Neto-Bruto / Net-Gross Weight	kg 21,5-24
Potência / Puissance / Potência / Power	W 210
Tensão / Tension / Tension / Tension	V 230





**BREMA**  
Ice Makers

**MÁQUINAS DE GELO EM CUBOS**  
MACHINES À GLAÇON EN CUBE  
FABRICADORES DE CUBITOS DE HIELO  
ICE CUBE MAKERS



	Ice Cube
Hotéis	● ● ●
Restaurantes	● ● ●
Fast Foods	● ● ●
Bares	● ● ●
Discotecas	● ● ●



MODELO / MODÈLE / MODELO / MODEL	CB 184A HC (A.B.S.)	CB 184A HC
CÓDIGO / CODE / CÓDIGO / CODE	2116.602	2116.604
<b>Preço / Prix / Precio / Price</b>	<b>€ 1.320,00</b>	<b>1.386,00</b>
Dimensões / Dimensions / Dimensiones	mm 355x 404x 590	355x 404x 590
Pés / Pieds / Pies / Feet	mm -	-
Capacidade depósito / Capacité dépôt / Capacidad deposito / Deposit capacity	kg 4	4
Produção de Cubos de gelo / Production cube à glaçon / Producción de Cubos de hielo/ Ice cube production	kg/24h 21	21
Tipo de Cubo / Type cube / Tipo Cubos / Ice cube type	gr 13	13
Consumo de água / Consommation d'eau / Consumo agua / Cycle Water consumption	lt/kg 4	4
Gás refrigerante / Gaz réfrigérant / Gas refrigerante / Refrigerant gas	R290	R290
Peso Líquido-Bruto / Poids Net-Brut / Peso Neto-Bruto / Net-Gross Weight	kg 27,5-34	27,5-34
Potência / Puissance / Potencia / Power	W 260	260
Tensão / Tension / Tensión / Tension	V 230	230



MODELO / MODÈLE / MODELO / MODEL	CB 246A HC	CB 249A HC
CÓDIGO / CODE / CÓDIGO / CODE	2116.606	2116.608
<b>Preço / Prix / Precio / Price</b>	<b>€ 1.577,00</b>	<b>1.652,00</b>
Dimensões / Dimensions / Dimensiones	mm 390x 460x 610	390x 460x 690
Pés / Pieds / Pies / Feet	mm 110/150	110/150
Capacidade depósito / Capacité dépôt / Capacidad deposito / Deposit capacity	kg 6	9
Produção de Cubos de gelo / Production cube à glaçon / Producción de Cubos de hielo/ Ice cube production	kg/24h 26	29
Tipo de Cubo / Type cube / Tipo Cubos / Ice cube type	gr 33	33
Consumo de água / Consommation d'eau / Consumo agua / Cycle Water consumption	lt/kg 5	5
Gás refrigerante / Gaz réfrigérant / Gas refrigerante / Refrigerant gas	R290	R290
Peso Líquido-Bruto / Poids Net-Brut / Peso Neto-Bruto / Net-Gross Weight	kg 35-41	37-44
Potência / Puissance / Potencia / Power	W 290	320
Tensão / Tension / Tensión / Tension	V 230	230



MODELO / MODÈLE / MODELO / MODEL	CB 316A HC
CÓDIGO / CODE / CÓDIGO / CODE	2116.610
<b>Preço / Prix / Precio / Price</b>	<b>€ 1.855,00</b>
Dimensões / Dimensions / Dimensiones	mm 500x 580x 690
Pés / Pieds / Pies / Feet	mm 110/150
Capacidade depósito / Capacité dépôt / Capacidad deposito / Deposit capacity	kg 16
Produção de Cubos de gelo / Production cube à glaçon / Producción de Cubos de hielo/ Ice cube production	kg/24h 38
Tipo de Cubo / Type cube / Tipo Cubos / Ice cube type	gr 33
Consumo de água / Consommation d'eau / Consumo agua / Cycle Water consumption	lt/kg 3
Gás refrigerante / Gaz réfrigérant / Gas refrigerante / Refrigerant gas	R290
Peso Líquido-Bruto / Poids Net-Brut / Peso Neto-Bruto / Net-Gross Weight	kg 48-56
Potência / Puissance / Potencia / Power	W 340
Tensão / Tension / Tensión / Tension	V 230

\* 5mm pés - pieds - pies - feet / \*\* 110-150mm pés reguláveis / pieds réglables / pies regulables / adjustable feet  
Acréscio à altura da máquina | En plus de la hauteur de la machine | Además de la altura de la máquina | In addition to the machine height

Modelo arrefecimento a água sob consulta / Modèle refroidissement à eau disponible  
Modelo enfriamiento por água disponível / Water cooling model available

	 Ice Cube
Hotéis	● ● ●
Restaurantes	● ● ●
Fast Foods	● ● ●
Bares	● ● ●
Discotecas	● ● ●



Modelo arrefecimento a água sob consulta / Modèle refroidissement à eau disponible  
Modelo enfriamiento por água disponible / Water cooling model available



MODELO / MODÈLE / MODELO / MODEL		CB 416A HC	CB 425A HC
CÓDIGO / CODE / CÓDIGO / CODE		2116.612	2116.614
<b>Preço / Prix / Precio / Price</b>	€	<b>2.021,00</b>	<b>2.152,00</b>
Dimensões / Dimensions / Dimensiones	mm	500x580x690	500x580x800
Pés / Pieds / Pies / Feet	mm	110/150	110/150
Capacidade depósito / Capacité dépôt / Capacidad deposito / Deposit capacity	kg	16	25
Produção de Cubos de gelo / Production cube à glaçon / Producción de Cubos de hielo/ Ice cube production	kg/24h	42	48
Tipo de Cubo / Type cube / Tipo Cubos / Ice cube type	gr	33	33
Consumo de água / Consommation d'eau / Consumo agua / Cycle Water consumption	lt/kg	3	3
Gás refrigerante / Gaz réfrigérant / Gas refrigerante / Refrigerant gas		R290	R290
Peso Líquido-Bruto / Poids Net-Brut / Peso Neto-Bruto / Net-Gross Weight	kg	52-60	56-64
Potência / Puissance / Potencia / Power	W	340	450
Tensão / Tension / Tensión / Tension	V	230	230



MODELO / MODÈLE / MODELO / MODEL		CB 425A HC
CÓDIGO / CODE / CÓDIGO / CODE		2116.616
<b>Preço / Prix / Precio / Price</b>	€	<b>2.152,00</b>
Dimensões / Dimensions / Dimensiones	mm	500x580x800
Pés / Pieds / Pies / Feet	mm	110/150
Capacidade depósito / Capacité dépôt / Capacidad deposito / Deposit capacity	kg	25
Produção de Cubos de gelo / Production cube à glaçon / Producción de Cubos de hielo/ Ice cube production	kg/24h	48
Tipo de Cubo / Type cube / Tipo Cubos / Ice cube type	gr	42
Consumo de água / Consommation d'eau / Consumo agua / Cycle Water consumption	lt/kg	3
Gás refrigerante / Gaz réfrigérant / Gas refrigerante / Refrigerant gas		R290
Peso Líquido-Bruto / Poids Net-Brut / Peso Neto-Bruto / Net-Gross Weight	kg	56-64
Potência / Puissance / Potencia / Power	W	450
Tensão / Tension / Tensión / Tension	V	230

\* Não inclui a medida dos pés reguláveis de (110-150mm) / Ne comprend pas la mesure des pieds réglables (110-150mm) / No incluye la medida de los pies regulables (110-150mm) / Doesn't include adjustable feet measures (110-150mm)



**BREMA**  
Ice Makers

**MÁQUINAS DE GELO EM CUBOS**  
MACHINES À GLAÇON EN CUBE  
FABRICADORES DE CUBITOS DE HIELO  
ICE CUBE MAKERS



	Ice Cube
Hotéis	● ● ●
Restaurantes	● ● ●
Fast Foods	● ● ●
Bares	● ● ●
Discotecas	● ● ●

Modelo arrefecimento a água sob consulta / Modèle refroidissement à eau disponible  
Modelo enfriamiento por água disponível / Water cooling model available



MODELO / MODÈLE / MODELO / MODEL		CB 640A HC	CB 640A HC
CÓDIGO / CODE / CÓDIGO / CODE		2116.618	2116.620
<b>Preço / Prix / Precio / Price</b>	€	<b>2.836,00</b>	<b>2.836,00</b>
Dimensões / Dimensions / Dimensiones	mm	738x600x920	738x600x920
Pés / Pieds / Pies / Feet	mm	110/150	110/150
Capacidade depósito / Capacité depôt / Capacidad deposito / Deposit capacity	kg	40	40
Produção de Cubos de gelo / Production cube à glaçon / Producción de Cubos de hielo / Ice cube production	kg/24h	72	72
Tipo de Cubo / Type cube / Tipo Cubos / Ice cube type	gr	33	42
Consumo de água / Consommation d'eau / Consumo agua / Cycle Water consumption	lt/kg	3	3
Gás refrigerante / Gaz réfrigérant / Gas refrigerante / Refrigerant gas		R290	R290
Peso Líquido-Bruto / Poids Net-Brut / Peso Neto-Bruto / Net-Gross Weight	kg	77-89	77-89
Potência / Puissance / Potencia / Power	W	620	620
Tensão / Tension / Tensión / Tension	V	230	230



MODELO / MODÈLE / MODELO / MODEL		CB 840A HC	CB 955A HC	CB 955A HC
CÓDIGO / CODE / CÓDIGO / CODE		2116.624	2116.626	2116.628
<b>Preço / Prix / Precio / Price</b>	€	<b>3.118,00</b>	<b>3.220,00</b>	<b>3.220,00</b>
Dimensões / Dimensions / Dimensiones	mm	738x600x920	738x600x1020	738x600x1020
Pés / Pieds / Pies / Feet	mm	110/150	110/150	110/150
Capacidade depósito / Capacité depôt / Capacidad deposito / Deposit capacity	kg	40	55	55
Produção de Cubos de gelo / Production cube à glaçon / Producción de Cubos de hielo / Ice cube production	kg/24h	80	95	95
Tipo de Cubo / Type cube / Tipo Cubos / Ice cube type	gr	33	33	42
Consumo de água / Consommation d'eau / Consumo agua / Cycle Water consumption	lt/kg	2	3	3
Gás refrigerante / Gaz réfrigérant / Gas refrigerante / Refrigerant gas		R290	R290	R290
Peso Líquido-Bruto / Poids Net-Brut / Peso Neto-Bruto / Net-Gross Weight	kg	86-98	89-102	89-102
Potência / Puissance / Potencia / Power	W	700	890	890
Tensão / Tension / Tensión / Tension	V	230	230	230



MODELO / MODÈLE / MODELO / MODEL		CB 1265 HC	CB 1565A HC	CB 1565A HC
CÓDIGO / CODE / CÓDIGO / CODE		2116.630	2116.220	2116.220B
<b>Preço / Prix / Precio / Price</b>	€	<b>4.302,00</b>	<b>4.534,00</b>	<b>4.534,00</b>
Dimensões / Dim / Dimensiones / Dimensions	mm	840x740x1075	840x740x1075	840x740x1075
Pés / Pieds / Pies / Feet	mm	110/150	110/150	110/150
Capacidade depósito / Capacité depôt / Capacidad deposito / Deposit capacity	kg	65	65	65
Produção de Cubos de gelo / Production cube à glaçon / Producción de Cubos de hielo / Ice cube production	kg/24h	134	155	155
Tipo de Cubo / Type cube / Tipo Cubos / Ice cube type	gr	33	33	42
Consumo de água / Consommation d'eau / Consumo agua / Cycle Water consumption	lt/kg	2	2,6	2,6
Gás refrigerante / Gaz réfrigérant / Gas refrigerante / Refrigerant gas		R290	R290	R290
Peso Líquido-Bruto / Poids Net-Brut / Peso Neto-Bruto / Net-Gross Weight	kg	113-133	118-138	118-138
Potência / Puissance / Potencia / Power	W	1250	1400	1400
Tensão / Tension / Tensión / Tension	V	230	230	230

\* Não inclui a medida dos pés reguláveis de (110-150mm) / Ne comprend pas la mesure des pieds réglables (110-150mm) / No incluye la medida de los pies regulables (110-150mm) / Doesn't include adjustable feet measures (110-150mm)



Modelo arrefecimento a água sob consulta / Modèle refroidissement à eau disponible  
Modelo enfriamiento por água disponible / Water cooling model available



MODELO / MODÈLE / MODELO / MODEL	C 150 A	
CÓDIGO / CODE / CÓDIGO / CODE	2116.224	
<b>Preço / Prix / Precio / Price</b>	<b>€</b>	<b>4.214,00</b>
Dimensões / Dimensions / Dimensiones	mm	862x555x720
Produção de Cubos de gelo / Production cube à glaçon / Producción de Cubos de hielo/ Ice cube production	kg/24h	155
Tipo de Cubo / Type cube / Tipo Cubos / Ice cube type	gr	33
Consumo de água / Cons. d'eau / Cons. agua / Cycle water cons.	lt	2,6
Gás refrigerante / Gaz réfrigérant / Gas refrigerante / Refrigerant gas		R290
Peso Líquido-Bruto / Poids Net-Brut / Peso Neto-Bruto / Net-Gross Weight	kg	118-128
Potência / Puissance / Potência / Power	W	1400
Tensão / Tension / Tension / Tension	V	230



MODELO / MODÈLE / MODELO / MODEL	C300 SPLIT*	
CÓDIGO / CODE / CÓDIGO / CODE	2116.227A	
<b>Preço / Prix / Precio / Price</b>	<b>€</b>	<b>5.477,00</b>
Dimensões / Dimensions / Dimensiones	mm	990x585x850
Capacidade frigorífica / Puissance frigorifique / Capacidad de refrigeración / Cooling capacity	W/°C	6000/-28°C
Produção de Cubos de gelo / Production cube à glaçon / Producción de Cubos de hielo/ Ice cube production	kg/24h	300
Tipo de Cubo / Type cube / Tipo Cubos / Ice cube type	gr	33
Consumo de água / Cons. d'eau / Cons. agua / Cycle water cons.	lt	2,6
Gás refrigerante / Gaz réfrigérant / Gas refrigerante / Refrigerant gas		R452A
Peso Líquido-Bruto / Poids Net-Brut / Peso Neto-Bruto / Net-Gross Weight	kg	97-107
Potência / Puissance / Potência / Power	W	200
Tensão / Tension / Tension / Tension	V	230



MODELO / MODÈLE / MODELO / MODEL	C300 A 230 V	C300 A 400 V
CÓDIGO / CODE / CÓDIGO / CODE	2116.226	2116.227
<b>Preço / Prix / Precio / Price</b>	<b>€ 6.950,00</b>	<b>6.950,00</b>
Dimensões / Dimensions / Dimensiones	mm 1250x580x848	1250x580x848
Produção de Cubos de gelo / Production cube à glaçon / Producción de Cubos de hielo/ Ice cube production	kg/24h 300	300
Tipo de Cubo / Type cube / Tipo Cubos / Ice cube type	gr 33	33
Consumo de água / Cons. d'eau / Cons. agua / Cycle water cons.	lt 2,6	2,6
Gás refrigerante / Gaz réfrigérant / Gas refrigerante / Refrigerant gas	R452A	R452A
Peso Líquido-Bruto / Poids Net-Brut / Peso Neto-Bruto / Net-Gross Weight	kg 152-178	152-178
Potência / Puissance / Potência / Power	W 2600	2600
Tensão / Tension / Tension / Tension	V 230	400



**BREMA**  
Ice Makers

**DEPÓSITOS - BIN MODELO C**  
RÉSERVES MODÈLES C  
DEPÓSITOS MODELO C  
C MODELS STORAGE

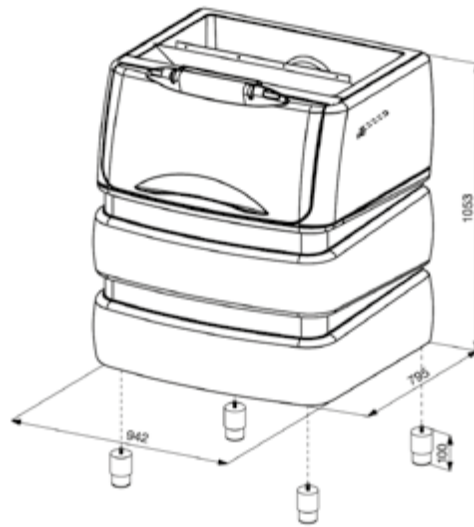

MODELO / MODÈLE / MODELO / MODEL	BIN 240 PE P/ C150 A	
CÓDIGO / CODE / CÓDIGO / CODE	2116.366	
<b>Preço / Prix / Precio / Price</b>	€	<b>1.867,00</b>
Dimensões / Dimensions / Dimensiones	mm	942x 795x 1053*
Cap. Depósito / Cap. depôt / Cap. deposito / Deposit capacity	kg	180
Peso Líquido-Bruto / Poids Net-Brut / Peso Neto-Bruto / Net-Gross Weight	kg	64-79



MODELO / MODÈLE / MODELO / MODEL	BIN 200 P/C150	
CÓDIGO / CODE / CÓDIGO / CODE	2116.409A	
<b>Preço / Prix / Precio / Price</b>	€	<b>2.094,00</b>
Dimensões / Dimensions / Dimensiones	mm	870x 790x 1000*
Cap. Depósito / Cap. depôt / Cap. deposito / Deposit capacity	kg	200
Peso Líquido-Bruto / Poids Net-Brut / Peso Neto-Bruto / Net-Gross Weight	kg	74-93



MODELO / MODÈLE / MODELO / MODEL	BIN 350 P/ C150 A	BIN 350 C300 A P/ VM 1700
CÓDIGO / CODE / CÓDIGO / CODE	2116.413	2116.414
<b>Preço / Prix / Precio / Price</b>	€	<b>3.047,00</b>
Dimensões / Dimensions / Dimensiones	mm	1250x 790x 1000*
Cap. Depósito / Cap. depôt / Cap. deposito / Deposit capacity	kg	350
Peso Líquido-Bruto / Poids Net-Brut / Peso Neto-Bruto / Net-Gross Weight	kg	105-126

\* Não inclui medida dos pés reguláveis (110-160mm) / Ne comprend pas la mesure des pieds réglables (110-160mm) / No incluye la medida de los pies regulables (110-160mm) / Doesn't include adjustable feet measures (110-160mm)



	Fast Ice
Hotéis	● ● ●
Restaurantes	● ● ●
Fast Foods	● ● ●
Bares	● ● ●
Discotecas	● ● ●
Peixarias	● ● ●
Supermercados	● ● ●
Farmácias	● ● ●
Indústria	● ● ●

Modelo arrefecimento a água sob consulta / Modèle refroidissement à eau disponible  
 Modelo enfriamiento por água disponível / Water cooling model available

Com depósito  
Avec dépôt  
Con el depósito  
With deposit



MODELO / MODÈLE / MODELO / MODEL	VB-250 A	
CÓDIGO / CODE / CÓDIGO / CODE	2116.276	
<b>Preço / Prix / Precio / Price</b>	€	<b>3.170,00</b>
Dimensões / Dimensions / Dimensiones	mm	738x600x980*
Cap. Depósito / Cap. depot / Cap. deposito / Deposit capacity	kg	35
Produção de Cubos de gelo / Production cube à glaçon / Producción de Cubos de hielo/ Ice cube production	kg/24h	105
Tipo de Cubo / Type cube / Tipo Cubos / Ice cube type	gr	7
Consumo de água / Cons. d'eau / Cons. agua / Cycle water cons.	lt/kg	2,5
Gás refrigerante / Gaz réfrigérant / Gas refrigerante / Refrigerant gas		R452A
Peso Líquido-Bruto / Poids Net-Brut / Peso Neto-Bruto / Net-Gross Weight	kg	75-85
Potência / Puissance / Potência / Power	W	850
Tensão / Tension / Tension / Tension	V	230

Sem depósito  
Sans dépôt  
Sin depósito  
Without deposit



MODELO / MODÈLE / MODELO / MODEL	VM-350 A	VM-500 A	VM-500 W	
CÓDIGO / CODE / CÓDIGO / CODE	2116.279	2116.280	2116.282	
<b>Preço / Prix / Precio / Price</b>	€	<b>3.682,00</b>	<b>4.540,00</b>	<b>4.594,00</b>
Dimensões / Dimensions / Dimensiones	mm	540x544x747	770x550x805	770x550x805
Produção de Cubos de gelo / Production cube à glaçon / Producción de Cubos de hielo/ Ice cube production	kg/24h	140	200	200
Tipo de Cubo / Type cube / Tipo Cubos / Ice cube type	gr	7	7	7
Consumo de água / Cons. d'eau / Cons. agua / Cycle water cons.	lt/kg	3	2,4	2,4
Gás refrigerante / Gaz réfrigérant / Gas refrigerante / Refrigerant gas		R452A	R452A	R452A
Peso Líquido-Bruto / Poids Net-Brut / Peso Neto-Bruto / Net-Gross Weight	kg	73-83	90-101	90-101
Potência / Puissance / Potência / Power	W	1 400	1 600	1 600
Tensão / Tension / Tension / Tension	V	230	230	230

Sem depósito  
Sans dépôt  
Sin depósito  
Without deposit



MODELO / MODÈLE / MODELO / MODEL	VM-900 A	VM-1700 A	
CÓDIGO / CODE / CÓDIGO / CODE	2116.284	2116.287	
<b>Preço / Prix / Precio / Price</b>	€	<b>6.374,00</b>	<b>12.274,00</b>
Dimensões / Dimensions / Dimensiones	mm	770x550x805	1250x645x950
Produção de Cubos de gelo / Production cube à glaçon / Producción de Cubos de hielo/ Ice cube production	kg/24h	400	770
Tipo de Cubo / Type cube / Tipo Cubos / Ice cube type	gr	7	7
Consumo de água / Cons. d'eau / Cons. agua / Cycle water cons.	lt/kg	1,8	1,4
Gás refrigerante / Gaz réfrigérant / Gas refrigerante / Refrigerant gas		R452A	R452A
Peso Líquido-Bruto / Poids Net-Brut / Peso Neto-Bruto / Net-Gross Weight	kg	113-124	186-242
Potência / Puissance / Potência / Power	W	3 000	4 300
Tensão / Tension / Tension / Tension	V	230	400

\* Não inclui a medida dos pés reguláveis de (110-150mm) / Ne comprend pas la mesure des pieds réglables (110-150mm) / No incluye la medida de los pies regulables (110-150mm) / Doesn't include adjustable feet measures (110-150mm)





**BREMA**  
Ice Makers

**DEPÓSITOS - BIN MODELO VM**  
RÉSERVES MODÈLES VM  
DEPÓSITOS MODELO VM  
VM MODELS STORAGE

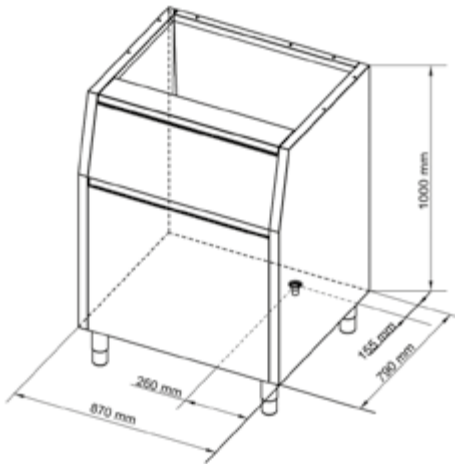

MODELO / MODÈLE / MODELO / MODEL	BIN 200 INOX P/ VM 350	BIN 200 INOX P/VM 500/900
CÓDIGO / CODE / CÓDIGO / CODE	2116.410	2116.410A
<b>Preço / Prix / Precio/ Price</b>	<b>€ 2.094,00</b>	<b>2.094,00</b>
Dimensões / Dimensions / Dimensiones	mm 870x790x1000*	870x790x1000*
Cap. Depósito / Cap. depot / Cap. deposito / Deposit capacity	kg 200	200
Peso Líquido-Bruto / Poids Net-Brut / Peso Neto-Bruto / Net-Gross Weight	kg 74-93	74-93

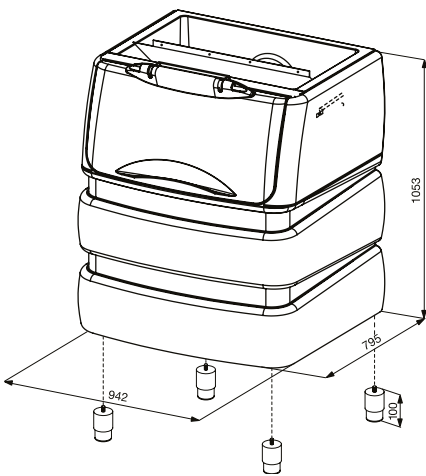

MODELO / MODÈLE / MODELO / MODEL	BIN 240 PE P/ VM 350	BIN 240 PE P/ VM 500/900
CÓDIGO / CODE / CÓDIGO / CODE	2116.367	2116.369
<b>Preço / Prix / Precio/ Price</b>	<b>€ 1.867,00</b>	<b>1.867,00</b>
Dimensões / Dimensions / Dimensiones	mm 942x795x1053*	942x795x1053*
Cap. Depósito / Cap. depot / Cap. deposito / Deposit capacity	kg 240	240
Peso Líquido-Bruto / Poids Net-Brut / Peso Neto-Bruto / Net-Gross Weight	kg 61-92	61-92



MODELO / MODÈLE / MODELO / MODEL	BIN 350 C300 A P/ VM 1700	BIN 350 P/ VM 500/900
CÓDIGO / CODE / CÓDIGO / CODE	2116.414	2116.414A
<b>Preço / Prix / Precio/ Price</b>	<b>€ 3.047,00</b>	<b>3.047,00</b>
Dimensões / Dimensions / Dimensiones	mm 1250x790x1000*	1250x790x1000*
Cap. Depósito / Cap. depot / Cap. deposito / Deposit capacity	kg 350	350
Peso Líquido-Bruto / Poids Net-Brut / Peso Neto-Bruto / Net-Gross Weight	kg 105-126	105-126

\* Não inclui medida dos pés reguláveis (110-160mm) / Ne comprend pas la mesure des pieds réglables (110-160mm) / No incluye la medida de los pies regulables (110-160mm) / Doesn't include adjustable feet measures (110-160mm)

**ID 70**

Distribuidor. Carga manual (gelo de 13 gr de outra máquina)  
 Distributeur. Chargement manuel (glace 13 gr, sur l'autre machine)  
 Distribuidor. Carga manual (13 gr de hielo de otra maquina)  
 Distributor. Manual charge (ice 13 gr of other machine)

**ID 70 X VM 350**

Modelo VM 350  
 não incluído

**ICE DISPENSER ID 70 PLUS X VM 350**

Combinado com o modelo VM 350 (cubos 7 gr) somente  
 Combiné avec le modèle VM 350 (Gr 7 cubes) seulement  
 Combina con el modelo VM 350 (Gr 7cubos) solamente  
 Combined with the model VM 350 (Gr 7 cubes) only

MODELO / MODÈLE / MODELO / MODEL	ID 70 X VM 350	
CÓDIGO / CODE / CÓDIGO / CODE	2116.296	
<b>Preço / Prix / Precio / Price</b>	€	<b>3.858,00</b>
Dimensões / Dimensions / Dimensiones	mm	568x799x817
Cap. Depósito / Cap. dépôt / Cap. deposito / Deposit capacity	kg	18/21
Peso Líquido-Bruto / Poids Net-Brut / Peso Neto-Bruto / Net-Gross Weight	kg	58-66
Potência / Puissance / Potência / Power	W	240
Tensão / Tension / Tension / Tension	V	230



**BREMA**  
Ice Makers

## MÁQUINAS DE GELO EM CUBO ENCASTRAR E DISTRIBUIDORES ÁGUA FRIA

MACHINES À GLAÇON EN CUBE D'ENCASTREMENT ET DISTRIBUTEUR D'EAU FROIDE

FABRICADORES DE HIELO EN CUBITOS DE EMPORTAR Y DISTRIBUIDORES DE AGUA FRÍA

ICE CUBE MAKERS FITTED AND CHILLED WATER DISPENSER



confirmar disponibilidade  
confirmer la disponibilité  
confirmar la disponibilidad  
confirm the availability



	Ice Cube
Hotéis	●●●
Restaurantes	●●●
Fast Foods	●●●
Bares	●●●
Discotecas	●●●



MODELO / MODÈLE / MODELO / MODEL	FRESH MAKER	
CÓDIGO / CODE / CÓDIGO / CODE	2116.271	
<b>Preço / Prix / Precio / Price</b>	€	<b>2.246,00</b>
Dimensões / Dimensions / Dimensiones	mm	540x430x435*
Cap. Depósito / Cap. dépôt / Cap. deposito / Deposit capacity	kg	4
Produção de Cubos de gelo / Production cube à glaçon / Producción de Cubos de hielo/ Ice cube production	kg/24h	22
Tipo de Cubo / Type cube / Tipo Cubos / Ice cube type	gr	13
Consumo de água / Cons. d'eau / Cons. agua / Cycle water cons.	lt/kg	37,4
Gás refrigerante / Gaz réfrigérant / Gas refrigerante / Refrigerant gas		R452A
Peso Líquido-Bruto / Poids Net-Brut / Peso Neto-Bruto / Net-Gross Weight	kg	37,5-42,5
Potência / Puissance / Potência / Power	W	320
Tensão / Tension / Tension / Tension	V	230



MODELO / MODÈLE / MODELO / MODEL	IW 45A	
CÓDIGO / CODE / CÓDIGO / CODE	2116.273	
<b>Preço / Prix / Precio / Price</b>	€	<b>3.245,00</b>
Dimensões / Dimensions / Dimensiones	mm	688x580x800*
Cap. Depósito / Cap. dépôt / Cap. deposito / Deposit capacity	kg	25
Produção de Cubos de gelo / Production cube à glaçon / Producción de Cubos de hielo/ Ice cube production	kg/24h	42
Tipo de Cubo / Type cube / Tipo Cubos / Ice cube type	gr	18
Consumo de água / Cons. d'eau / Cons. agua / Cycle water cons.	lt/kg	37,4
Gás refrigerante / Gaz réfrigérant / Gas refrigerante / Refrigerant gas		R404A
Peso Líquido-Bruto / Poids Net-Brut / Peso Neto-Bruto / Net-Gross Weight	kg	71-80
Potência / Puissance / Potência / Power	W	450
Tensão / Tension / Tension / Tension	V	230



MODELO / MODÈLE / MODELO / MODEL	INCAS IC 18	INCAS IC 24	INCAS IC 30	
CÓDIGO / CODE / CÓDIGO / CODE	2116.251	2116.252	2116.253	
<b>Preço / Prix / Precio / Price</b>	€	<b>1.857,00</b>	<b>2.228,00</b>	<b>2.028,00</b>
Dimensões / Dimensions / Dimensiones	mm	540x430x470*	595x510x502*	705x625x560*
Cap. Depósito / Cap. dépôt / Cap. deposito / Deposit capacity	kg	4	6	-
Produção de Cubos de gelo / Production cube à glaçon / Producción de Cubos de hielo/ Ice cube production	kg/24h	22	26	30
Tipo de Cubo / Type cube / Tipo Cubos / Ice cube type	gr	13	18	17
Consumo de água / Cons. d'eau / Cons. agua / Cycle water cons.	lt/kg	4,5	5,1	-
Gás refrigerante / Gaz réfrigérant / Gas refrigerante / Refrigerant gas		R452A	R452A	R452A
Peso Líquido-Bruto / Poids Net-Brut / Peso Neto-Bruto / Net-Gross Weight	kg	34-39	41-48	-
Potência / Puissance / Potência / Power	W	320	350	490
Tensão / Tension / Tension / Tension	V	230	230	230



MODELO / MODÈLE / MODELO / MODEL	DSS 42 A SELF SERVICE	DSS 42W SELF SERVICE	
CÓDIGO / CODE / CÓDIGO / CODE	2116.254	2116.255	
<b>Preço / Prix / Precio / Price</b>	€	<b>3.388,00</b>	<b>3.438,00</b>
Dimensões / Dimensions / Dimensiones	mm	500x630x920	500x630x920
Cap. Depósito / Cap. dépôt / Cap. deposito / Deposit capacity	kg	12	12
Produção de Cubos de gelo / Production cube à glaçon / Producción de Cubos de hielo/ Ice cube production	kg/24h	44	44
Tipo de Cubo / Type cube / Tipo Cubos / Ice cube type	gr	13	13
Consumo de água / Cons. d'eau / Cons. agua / Cycle water cons.	lt/kg	15	15
Gás refrigerante / Gaz réfrigérant / Gas refrigerante / Refrigerant gas		R452A	R452A
Peso Líquido-Bruto / Poids Net-Brut / Peso Neto-Bruto / Net-Gross Weight	kg	66-74	66-74
Potência / Puissance / Potência / Power	W	450	450
Tensão / Tension / Tension / Tension	V	230	230

\* Não inclui medida dos pés (5mm) / Ne comprend la mesure pas les pieds (5mm) / No incluye la medida de los pies (5mm) / Doesn't include feet measures (5mm)

A - Arrefecimento a ar / Refroidissement à air / Enfriamiento por aire / Air-cooling system

Hotéis	● ● ●
Restaurantes	● ● ●
Fast Foods	● ● ●
Bares	● ● ●
Discotecas	● ● ●
Peixarias	● ● ●
Supermercados	● ● ●
Farmácias	● ● ●
Indústria	● ● ●



# ESPECIAL CAIPIRINHA

Modelo arrefecimento a água sob consulta / Modèle refroidissement à eau disponible  
 Modelo enfriamiento por água disponible / Water cooling model available

Com depósito  
 Avec dépôt  
 Con el depósito  
 With deposit



MODELO / MODÈLE / MODELO / MODEL		TB 551 A HC	TB 852 A HC	TB 1405 A HC
<b>CÓDIGO / CODE / CÓDIGO / CODE</b>		<b>2116.554</b>	<b>2116.546</b>	<b>2116.550</b>
<b>Preço / Prix / Precio / Price</b>	<b>€</b>	<b>3.702,00</b>	<b>3.760,00</b>	<b>4.436,00</b>
Dimensões / Dimensions / Dimensiones	mm	450x620x680*	500x660x690**	738x690x1020**
Cap. Depósito / Cap. dépôt / Cap. deposito / Deposit capacity	kg	10	20	50
Produção de gelo / Production glaçon / Producción de hielo/ Ice production	kg/24h	57	90	146
Consumo de água / Cons. d'eau / Cons. agua / Cycle water cons.	lt	1	1	1
Gás refrigerante / Gaz réfrigérant / Gas refrigerante / Refrigerant gas		R290	R290	R290
Peso Líquido-Bruto / Poids Net-Brut / Peso Neto-Bruto / Net-Gross Weight	kg	56-64	59-67	94-105
Potência / Puissance / Potência / Power	W	410	440	720
Tensão / Tension / Tension / Tension	V	230	230	230

\* 5mm Pés / Pieds / Pies / Feet | \*\* 110-150 mm Pés reguláveis / Pieds réglables / Pies regulables / Adjustable feet  
 Acresce à altura da máquina | En plus de la hauteur de la machine | Además de la altura de la máquina | In addition to the machine height

Sem depósito  
 Sans dépôt  
 Sin depósito  
 Without deposit



MODELO / MODÈLE / MODELO / MODEL		TM 140 A HC	TM 250 A HC	TM 450 A HC
<b>CÓDIGO / CODE / CÓDIGO / CODE</b>		<b>2116.228</b>	<b>2116.228A</b>	<b>2116.229</b>
<b>Preço / Prix / Precio / Price</b>	<b>€</b>	<b>4.542,00</b>	<b>6.310,00</b>	<b>7.298,00</b>
Dimensões / Dimensions / Dimensiones	mm	560x569x600	560x569x695	560x569x695
Produção de gelo / Production glaçon / Producción de hielo/ Ice production	kg/24h	130	245	350
Consumo de água / Cons. d'eau / Cons. agua / Cycle water cons.	lt	1	1	1
Gás refrigerante / Gaz réfrigérant / Gas refrigerante / Refrigerant gas		R290	R290	R290
Peso Líquido-Bruto / Poids Net-Brut / Peso Neto-Bruto / Net-Gross Weight	kg	63-74	83-93	102-113
Potência / Puissance / Potência / Power	W	700	1050	1415
Tensão / Tension / Tension / Tension	V	230	230	230



MODELO / MODÈLE / MODELO / MODEL		BIN 200 INOX (G160 G280 G510)	BIN 350 P/ TM450
<b>CÓDIGO / CODE / CÓDIGO / CODE</b>		<b>2116.411</b>	<b>2116.416</b>
<b>Preço / Prix / Precio / Price</b>	<b>€</b>	<b>2.094,00</b>	<b>3.047,00</b>
Dimensões / Dimensions / Dimensiones	mm	870x790x1000*	1250x790x1000**
Produção de gelo / Production glaçon / Producción de hielo/ Ice production	kg/24h	200	350
Peso Líquido-Bruto / Poids Net-Brut / Peso Neto-Bruto / Net-Gross Weight	kg	74-93	105-126

\*\* 110-160 mm Pés reguláveis / Pieds réglables / Pies regulables / Adjustable feet  
 Acresce à altura da máquina | En plus de la hauteur de la machine | Además de la altura de la máquina | In addition to the machine height



**BREMA**  
Ice Makers

## MÁQUINAS DE GELO EM FLOCO COM DEPÓSITO

MACHINES À GLAÇON EN GRAINS AVEC RESERVE  
FABRICADORES DE HIELO TRITURADO CON DEPOSITO  
GRANULAR ICE FLAKES MAKERS WITH STORAGE



	Ice Flakes
Hotéis	● ● ●
Restaurantes	● ● ●
Fast Foods	● ● ●
Bares	● ● ●
Discotecas	● ● ●
Peixarias	● ● ●
Supermercados	● ● ●
Farmácias	● ● ●
Indústria	● ● ●

Modelo arrefecimento a água sob consulta / Modèle refroidissement à eau disponible  
Modelo enfriamiento por água disponível / Water cooling model available



MODELO / MODÈLE / MODELO / MODEL	GB 601 A HC	
CÓDIGO / CODE / CÓDIGO / CODE	2116.306	
<b>Preço / Prix / Precio / Price</b>	<b>€</b>	<b>3.397,00</b>
Dimensões / Dimensions / Dimensiones	mm	450x620x 680*
Cap. Depósito / Cap. dépôt / Cap. deposito / Deposit capacity	kg	10
Produção de gelo / Production glaçon / Producción de hielo/ Ice production	kg/24h	67
Consumo de água / Cons. d'eau / Cons. agua / Cycle water cons.	lt/kg	1
Gás refrigerante / Gaz réfrigérant / Gas refrigerante / Refrigerant gas		R290
Peso Líquido-Bruto / Poids Net-Brut / Peso Neto-Bruto / Net-Gross Weight	kg	56-64
Potência / Puissance / Potência / Power	W	400
Tensão / Tension / Tension / Tension	V	230



MODELO / MODÈLE / MODELO / MODEL	GB 902 A HC	GB 903 A HC
CÓDIGO / CODE / CÓDIGO / CODE	2116.300	2116.307
<b>Preço / Prix / Precio / Price</b>	<b>€</b>	<b>3.519,00</b>
Dimensões / Dimensions / Dimensiones	mm	500x660x 690**
Cap. Depósito / Cap. dépôt / Cap. deposito / Deposit capacity	kg	20
Produção de gelo / Production glaçon / Producción de hielo/ Ice production	kg/24h	113
Consumo de água / Cons. d'eau / Cons. agua / Cycle water cons.	lt/kg	1
Gás refrigerante / Gaz réfrigérant / Gas refrigerante / Refrigerant gas		R290
Peso Líquido-Bruto / Poids Net-Brut / Peso Neto-Bruto / Net-Gross Weight	kg	59-67
Potência / Puissance / Potência / Power	W	470
Tensão / Tension / Tension / Tension	V	230



MODELO / MODÈLE / MODELO / MODEL	GB 1540 A HC	GB 1555 A HC
CÓDIGO / CODE / CÓDIGO / CODE	2116.310	2116.632
<b>Preço / Prix / Precio / Price</b>	<b>€</b>	<b>4.222,00</b>
Dimensões / Dimensions / Dimensiones	mm	738x690x 920**
Cap. Depósito / Cap. dépôt / Cap. deposito / Deposit capacity	kg	40
Produção de gelo / Production glaçon / Producción de hielo/ Ice production	kg/24h	153
Consumo de água / Cons. d'eau / Cons. agua / Cycle water cons.	lt/kg	1
Gás refrigerante / Gaz réfrigérant / Gas refrigerante / Refrigerant gas		R290
Peso Líquido-Bruto / Poids Net-Brut / Peso Neto-Bruto / Net-Gross Weight	kg	85-95
Potência / Puissance / Potência / Power	W	700
Tensão / Tension / Tension / Tension	V	230

\* 5mm Pés / Pieds / Pies / Feet | \*\* 110-150 mm Pés reguláveis / Pieds réglables / Pies regulables / Adjustable feet  
Acrésc. à altura da máquina | En plus de la hauteur de la machine | Además de la altura de la máquina | In addition to the machine height



	Ice Flakes
Hotéis	●●●●
Restaurantes	●●●●
Fast Foods	●●●●
Bares	●●●●
Discotecas	●●●●
Peixarias	●●●●
Supermercados	●●●●
Farmácias	●●●●
Indústria	●●●●



G 160 A HC	G 280 A HC	G 510 A HC 230V	G 510 A HC 400V
2116.328	2116.332	2116.336	2116.336A



G 1000 A
2116.345

Modelo arrefecimento a água sob consulta / Modèle refroidissement à eau disponible  
 Modelo enfriamiento por água disponible / Water cooling model available

MODELO / MODÈLE / MODELO / MODEL		G 160 A HC	G 280 A HC	G 510 A HC 230V	G 510 A 400V	G 1000 A
CÓDIGO / CODE / CÓDIGO / CODE		2116.328	2116.332	2116.336	2116.336A	2116.345
<b>Preço / Prix / Precio / Price</b>	€	<b>4.161,00</b>	<b>5.769,00</b>	<b>6.940,00</b>	<b>6.940,00</b>	<b>15.072,00</b>
Dimensões / Dimensions / Dimensiones	mm	560x569x600	560x569x695	560x569x695	560x569x695	934x684x700
Produção de gelo / Production glaçon / Producción de hielo/ Ice production	kg/24h	157	280	400	400	1000
Consumo de água / Cons. d'eau / Cons. agua / Cycle water cons.	lt/kg	1	1	1	1	1
Gás refrigerante / Gaz réfrigérant / Gas refrigerante / Refrigerant gas		R290	R290	R290	R452A	R452A
Peso Líquido-Bruto / Poids Net-Brut / Peso Neto-Bruto /Net-Gross Weight	kg	63-74	83-93	102-113	102-113	177-207
Potência / Puissance / Potência / Power	W	830	1100	1400	1400	3200
Tensão / Tension / Tension / Tension	V	230	230	230	400	400

	Ice Flakes
Hotéis	●●●●
Restaurantes	●●●●
Fast Foods	●●●●
Bares	●●●●
Discotecas	●●●●
Peixarias	●●●●
Supermercados	●●●●
Farmácias	●●●●
Indústria	●●●●



G510 SPLIT  
2116.339



G700 SPLIT  
CO2  
2116.339A



G 1400 SPLIT  
CO2  
2116.339B

SPLIT sob pedido / sur demande / a pedido / on request

MODELO / MODÈLE / MODELO / MODEL		G510 SPLIT	G700 SPLIT CO2	G 1400 SPLIT CO2
CÓDIGO / CODE / CÓDIGO / CODE		2116.339	2116.339A	2116.339B
<b>Preço / Prix / Precio / Price</b>	€	<b>5.704,00</b>	<b>5.756,00</b>	<b>11.444,00</b>
Dimensões / Dimensions / Dimensiones	mm	560x569x695	560x569x695	765x600x695
Capacidade frigorífica / Puissance frigorifique / Capacidad de refrigeración / Cooling capacity	w	2300	2300	4600
Produção de gelo / Production glaçon / Producción de hielo/ Ice production	kg/24h	510	720	1400
Consumo de água / Cons. d'eau / Cons. agua / Cycle water cons.	lt/kg	1	1	1
Gás refrigerante / Gaz réfrigérant / Gas refrigerante / Refrigerant gas		R452A	R744	R744
Peso Líquido-Bruto / Poids Net-Brut / Peso Neto-Bruto /Net-Gross Weight	kg	67-77	67-77	118-132
Potência / Puissance / Potência / Power	W	175	175	350
Tensão / Tension / Tension / Tension	V	230	230	230

SPLIT G510 / G1000

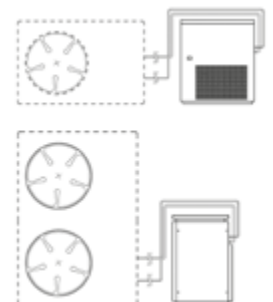

\*Sem unidade frigorífica / Sans unité de réfrigération / Sin unidad de refrigeración / Without refrigeration unit | \*\* Para padaria / Pour boulangerie / Para panadería / For bakery



**BREMA**  
Ice Makers

**DEPÓSITOS - BIN MODELO G**  
RÉSERVES MODÈLES G  
DEPÓSITOS MODELO G  
G MODELS STORAGE



MODELO / MODÈLE / MODELO / MODEL	BIN110 (G160 G280 G510 TM450)	
CÓDIGO / CODE / CÓDIGO / CODE	2116.353	
<b>Preço / Prix / Precio / Price</b>	€	<b>1.745,00</b>
Dimensões / Dimensions / Dimensiones	mm	560x815x1000*
Cap. Depósito / Cap. depot / Cap. deposito / Deposit capacity	kg	100
Peso Líquido-Bruto / Poids Net-Brut / Peso Neto-Bruto / Net-Gross Weight	kg	53-63



MODELO / MODÈLE / MODELO / MODEL	BIN 240 PE P/G280 / G510	
CÓDIGO / CODE / CÓDIGO / CODE	2116.382	
<b>Preço / Prix / Precio / Price</b>	€	<b>1.867,00</b>
Dimensões / Dimensions / Dimensiones	mm	942x795x1053*
Cap. Depósito / Cap. depôt / Cap. deposito / Deposit capacity	kg	180
Peso Líquido-Bruto / Poids Net-Brut / Peso Neto-Bruto / Net-Gross Weight	kg	64-79



MODELO / MODÈLE / MODELO / MODEL	BIN 200 INOX (G160 G280 G510)	BIN 350 (G280 G510)	
CÓDIGO / CODE / CÓDIGO / CODE	2116.411	2116.414B	
<b>Preço / Prix / Precio / Price</b>	€	<b>2.094,00</b>	<b>3.047,00</b>
Dimensões / Dimensions / Dimensiones	mm	870x790x1000*	1250x790x1000*
Cap. Depósito / Cap. depôt / Cap. deposito / Deposit capacity	kg	200	350
Peso Líquido-Bruto / Poids Net-Brut / Peso Neto-Bruto / Net-Gross Weight	kg	74-93	105-126



MODELO / MODÈLE / MODELO / MODEL	ROLLER BIN 100 (G280/G510)	
CÓDIGO / CODE / CÓDIGO / CODE	2116.420	
<b>Preço / Prix / Precio / Price</b>	€	<b>3.047,00</b>
Dimensões / Dimensions / Dimensiones	mm	795x1060x1284
Cap. Depósito / Cap. depôt / Cap. deposito / Deposit capacity	kg	108
Peso Líquido-Bruto / Poids Net-Brut / Peso Neto-Bruto / Net-Gross Weight	kg	64-80



\* 110-160mm pés reguláveis / pieds réglables / pies regulables / adjustable feet  
Acresce à altura da máquina | En plus de la hauteur de la machine | Además de la altura de la máquina | In addition to the machine height

Modelo arrefecimento a água sob consulta / Modèle refroidissement à eau disponible  
Modelo enfriamiento por água disponible / Water cooling model available



MODELO / MODÈLE / MODELO / MODEL	MUSTER 250 A	
CÓDIGO / CODE / CÓDIGO / CODE	2116.256A	
<b>Preço / Prix / Precio / Price</b>	<b>€</b>	<b>9.417,00</b>
Dimensões / Dimensions / Dimensiones	mm	870x550x 600
Produção de gelo / Production de glaçon / Producción de hielo/ Ice production	kg/24h	250
Consumo água /Cons.d'eau/ Cons. agua/Cycle water cons.	lt/kg	1
Peso Líquido-Bruto /Poids Net-Brut /Peso Neto-Bruto /Net-Gross Weight	kg	100/120
Gás refrigerante / Gaz réfrigérant / Gas refrigerante / Refrigerant gas		R452A
Potência / Puissance / Potência / Power	W	1700
Tensão / Tension / Tension / Tension	V	230

	Cold Flakes
Hotéis	●●●●
Restaurantes	●●●●
Fast Foods	●●●●
Bares	●●●●
Discotecas	●●●●
Peixarias	●●●●
Supermercados	●●●●
Farmácias	●●●●
Indústria	●●●●



MODELO / MODÈLE / MODELO / MODEL	MUSTER 350 A	
CÓDIGO / CODE / CÓDIGO / CODE	2116.261	
<b>Preço / Prix / Precio / Price</b>	<b>€</b>	<b>10.947,00</b>
Dimensões / Dimensions / Dimensiones	mm	900x588x 705
Produção de gelo / Production de glaçon / Producción de hielo/ Ice production	kg/24h	400
Consumo água /Cons.d'eau/ Cons. agua/Cycle water cons.	lt/kg	1/7,5
Peso Líquido-Bruto /Poids Net-Brut /Peso Neto-Bruto /Net-Gross Weight	kg	137/152
Gás refrigerante / Gaz réfrigérant / Gas refrigerante / Refrigerant gas		R452A
Potência / Puissance / Potência / Power	W	2100
Tensão / Tension / Tension / Tension	V	230



MODELO / MODÈLE / MODELO / MODEL	MUSTER 600 A	MUSTER 800 A	MUSTER 1500 A
CÓDIGO / CODE / CÓDIGO / CODE	2116.267	2116.258	2116.270
<b>Preço / Prix / Precio / Price</b>	<b>€ 13.213,00</b>	<b>18.017,00</b>	<b>29.075,00</b>
Dimensões / Dimensions / Dimensiones	mm 900x588x 705	mm 1107x700x 880	mm 1107x700x 970
Produção de gelo / Production de glaçon / Producción de hielo/ Ice production	kg/24h 620	kg/24h 900	kg/24h 1500
Consumo água /Cons.d'eau/ Cons. agua/Cycle water cons.	lt/kg 1	lt/kg 1	lt/kg 1
Peso Líquido-Bruto /Poids Net-Brut /Peso Neto-Bruto /Net-Gross Weight	kg 151/166	kg 241/262	kg 306/342
Gás refrigerante / Gaz réfrigérant / Gas refrigerante / Refrigerant gas	R452A	R452A	R452A
Potência / Puissance / Potência / Power	W 3000	W 4600	W 6000
Tensão / Tension / Tension / Tension	V 400	V 400	V 400



MODELO / MODÈLE / MODELO / MODEL	MUSTER 2000 A	
CÓDIGO / CODE / CÓDIGO / CODE	2116.260	
<b>Preço / Prix / Precio / Price</b>	<b>€</b>	<b>38.194,00</b>
Dimensões / Dimensions / Dimensiones	mm	1062x832x 1423
Produção de gelo / Production de glaçon / Producción de hielo/ Ice production	kg/24h	2300
Consumo água /Cons.d'eau/ Cons. agua/Cycle water cons.	lt/kg	1
Peso Líquido-Bruto /Poids Net-Brut /Peso Neto-Bruto /Net-Gross Weight	kg	520/570
Gás refrigerante / Gaz réfrigérant / Gas refrigerante / Refrigerant gas		R452A
Potência / Puissance / Potência / Power	W	7000
Tensão / Tension / Tension / Tension	V	400



MODELO / MODÈLE / MODELO / MODEL	MUSTER 5000 A	
CÓDIGO / CODE / CÓDIGO / CODE	2116.270A	
<b>Preço / Prix / Precio / Price</b>	<b>€</b>	<b>69.552,00</b>
Dimensões / Dimensions / Dimensiones	mm	1270x1400x 1620
Produção de gelo / Production de glaçon / Producción de hielo/ Ice production	kg/24h	5000
Consumo água /Cons.d'eau/ Cons. agua/Cycle water cons.	lt/kg	1
Peso Líquido-Bruto /Poids Net-Brut /Peso Neto-Bruto /Net-Gross Weight	kg	1000/1130
Gás refrigerante / Gaz réfrigérant / Gas refrigerante / Refrigerant gas		R452A
Potência / Puissance / Potência / Power	W	16000
Tensão / Tension / Tension / Tension	V	400

A - Arrefecimento a ar / Refroidissement à air / Enfriamiento por aire / Air-cooling system  
W - Arrefecimento a Água / Refroidissement à eau / Enfriamiento por agua / Water-cooling system





**BREMA**  
Ice Makers

**MÁQUINAS DE GELO EM ESCAMAS**  
MACHINES À ÉCAILLES  
FABRICADORES DE HIELO EN ESCAMAS  
FLAT ICE MAKERS



**SPLIT**  
sob pedido / sur demande / a pedido / on request



MODELO / MODÈLE / MODELO / MODEL		SPLIT 350*	SPLIT 600*	SPLIT 800*
CÓDIGO / CODE / CÓDIGO / CODE		2116.238	2116.239	2116.240
<b>Preço / Prix / Precio / Price</b>	€	<b>7.999,00</b>	<b>8.734,00</b>	<b>11.608,00</b>
Dimensões / Dimensions / Dimensiones	mm	495X588X 705	495X588x 705	604X700X 880
Produção de gelo / Production de glaçon / Producción de hielo/ Ice production	kg/24h	400	620	900
Capacidade frigorífica / Puissance frigorifique / Capacidad de refrigeración / Cooling capacity	W/°C	2200 W(-23°C)	3500 W(-22°C)	5000 W(-23°C)
Consumo de água / Cons.d'eau/ Cons. agua/Cycle water cons.	lt/kg	1	-	-
Gás refrigerante / Gaz réfrigérant / Gas refrigerante / Refrigerant gas		R452A	R452A	R452A
Peso Líquido-Bruto / Poids Net-Brut / Peso Neto-Bruto / Net-Gross Weight	kg	66/82	73/89	138/153
Potência / Puissance / Potência / Power	W	180	180	180
Tensão / Tension / Tension / Tension	V	230	230	230



MODELO / MODÈLE / MODELO / MODEL		SPLIT 1500*	SPLIT 2000*
CÓDIGO / CODE / CÓDIGO / CODE		2116.244	2116.242
<b>Preço / Prix / Precio / Price</b>	€	<b>16.876,00</b>	<b>25.185,00</b>
Dimensões / Dimensions / Dimensiones	mm	604X700X 970	736X832X 1075
Produção de gelo / Production de glaçon / Producción de hielo/ Ice production	kg/24h	1500	2200
Capacidade frigorífica / Puissance frigorifique / Capacidad de refrigeración / Cooling capacity	W/°C	8550 W(-24°C)	12000 W(-27°C)
Gás refrigerante / Gaz réfrigérant / Gas refrigerante / Refrigerant gas		R452A	R452A
Peso Líquido-Bruto / Poids Net-Brut / Peso Neto-Bruto / Net-Gross Weight	kg	144/160	300/328
Potência / Puissance / Potência / Power	W	180	180
Tensão / Tension / Tension / Tension	V	230	400



MODELO / MODÈLE / MODELO / MODEL		SPLIT 5000
CÓDIGO / CODE / CÓDIGO / CODE		2116.270B
<b>Preço / Prix / Precio / Price</b>	€	<b>48.865,00</b>
Dimensões / Dimensions / Dimensiones	mm	1270x1015x1076
Produção de gelo / Production de glaçon / Producción de hielo/ Ice production	kg/24h	5000
Capacidade frigorífica / Puissance frigorifique / Capacidad de refrigeración / Cooling capacity	W/°C	25000 W(-27°C)
Consumo de água / Cons.d'eau/ Cons. agua/Cycle water cons.	lt/kg	1
Gás refrigerante / Gaz réfrigérant / Gas refrigerante / Refrigerant gas		R452A
Peso Líquido-Bruto / Poids Net-Brut / Peso Neto-Bruto / Net-Gross Weight	kg	-
Potência / Puissance / Potência / Power	W	360
Tensão / Tension / Tension / Tension	V	400

\* Para ligação às unidades frigoríficas / Pour ligations à des unités frigorifiques / Para conexiones a unidades frigoríficas / Version to be connected to freezer units

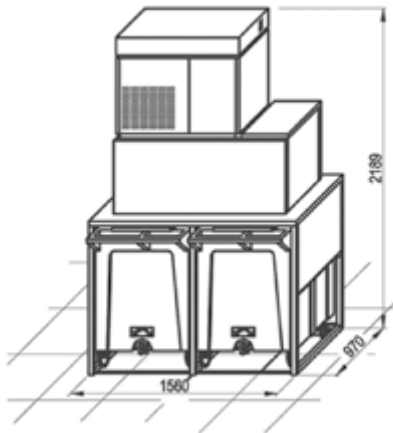

<b>BIN 350 P/MUSTER 350/600 SPLIT 350/600</b>	<b>DUPLO ROLLER BIN 100 P/MUSTER 350 /600</b>
<b>2116.414C</b>	<b>2116.435</b>



<b>BIN 550 DS P/MUSTER 800 / 1500</b>
<b>2116.447</b>

MODELO / MODÈLE / MODELO / MODEL		BIN 200 INOX P/ MUSTER 250	BIN 350 P/MUSTER 350/600 SPLIT 350/600	BIN 350 P/ M250 / SPLIT350-600	DUPLO ROLLER BIN 100 P/ MUSTER 350 /600	BIN 550 DS P/ MUSTER 800 / 1500
CÓDIGO / CODE / CÓDIGO / CODE		2116.412	2116.414C	2116.415A	2116.435	2116.447
<b>Preço / Prix / Precio / Price</b>	€	<b>2.094,00</b>	<b>3.047,00</b>	<b>3.047,00</b>	<b>7.907,00</b>	<b>9.990,00</b>
Dimensões / Dimensions / Dimensiones	mm	870x790x1000*	1250x790x1000*	1250x790x1000*	1560x1060x1484	1110x1060x1915
Cap. Depósito / Cap. depot / Cap. deposito / Deposit capacity	kg	200	350	350	108x2	550
Cap. Reserva / Cap. de Réserve / Cap. Reserva / Reserve Cap.	kg/24h	-	-	-	50	-
Peso Líquido-Bruto / Poids Net-Brut / Peso Neto-Bruto / Net-Gross Weight	kg	74-93	105-126	105-126	135-170	163-177

\* 110-160mm pés reguláveis / pieds réglables / pies regulables / adjustable feet

Acresce à altura da máquina | En plus de la hauteur de la machine | Además de la altura de la máquina | In addition to the machine height

## MÁQUINAS DE GELO ESCAMAS SPLIT CO2

MACHINES À ÉCAILLES SPLIT CO2

FABRICADORES DE HIELO EN ESCAMAS SPLIT CO2

FLAT ICE MAKERS SPLIT CO2



A ligação de CO2 substitui a utilização de gases fluorados que são nocivos para a atmosfera.



La connexion CO2 remplace l'utilisation de gaz fluorés qui sont nocifs pour l'atmosphère.



La conexión de CO2 sustituye el uso de gases fluorados que son perjudiciales para la atmósfera.



The CO2 connection replaces the use of fluorinated gases which are harmful to the atmosphere.

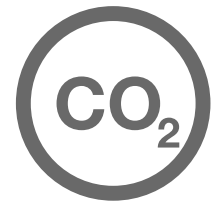

MODELO / MODÈLE / MODELO / MODEL		SPLIT M600 CO2	SPLIT M1000 CO2	SPLIT M 1500 CO2
CÓDIGO / CODE / CÓDIGO / CODE		2116.339C	2116.339D	2116.339E
<b>Preço / Prix / Precio / Price</b>	€	<b>9.103,00</b>	<b>14.436,00</b>	<b>17.995,00</b>
Dimensões / Dimensions / Dimensiones	mm	495x588x705	604x700x880	604x700x970
Produção de gelo / Production de glaçon / Producción de hielo/ Ice production	kg/24h	620	1040	1520
Capacidade frigorífica / Puissance frigorifique / Capacidad de refrigeración / Cooling capacity	W/°C	3500	5000	8550
Peso Líquido-Bruto / Poids Net-Brut / Peso Neto-Bruto / Net-Gross Weight	kg	73/89	138/153	144/160
Potência / Puissance / Potência / Power	w	180	180	180
Tensão / Tension / Tension / Tension	V	230	230	230



### TIPOS DE GELO / TYPES DE GLACE / TIPOS DE HIELO / TYPES OF ICE



**ICE CUBE**



**FAST ICE**



**ICE FLAKES**



**COLD FLAKES**

Usado recomendado / Légende usage recommandé / Uso recomendado leyenda / Recommended use legend

	ICE CUBE	PEBBLES ICE	FAST ICE	ICE FLAKES	COLD FLAKES	ICE FINGER
Hotéis	●●●	●●●○	●●●○	●●●○	●●●○	●●●○
Restaurantes	●●●	●●●○	●●●○	●●●○	●●●○	●●●○
Fast Foods	●●●○	●●●○	●●●○	●●●○	●●●○	●●●○
Bares	●●●	●●●○	●●●○	●●●○	●●●○	●●●○
Discotecas	●●●	●●●○	●●●○	●●●○	●●●○	●●●○
Peixarias	●●●○	●●●○	●●●○	●●●○	●●●○	●●●○
Supermercados	●●●○	●●●○	●●●○	●●●○	●●●○	●●●○
Farmácias	●●●○	●●●○	●●●○	●●●○	●●●○	●●●○
Indústria	●●●○	●●●○	●●●○	●●●○	●●●○	●●●○

●●●  
Altamente recomendado  
Hautelement recommandé  
Altamente recomendado  
Highly recommended

●●  
Recomendado  
Recommandé  
Recomendado  
Recommended

●  
Recomendado para certas aplicações  
Recommandé pour certaines applications  
Recomendado para ciertas aplicaciones  
Recommended for certain applications

○  
Não recomendado  
Non recommandé  
No se recomienda  
Not recommended

### TIPOS DE GELO / TYPES DE GLACE / TIPOS DE HIELO / TYPES OF ICE

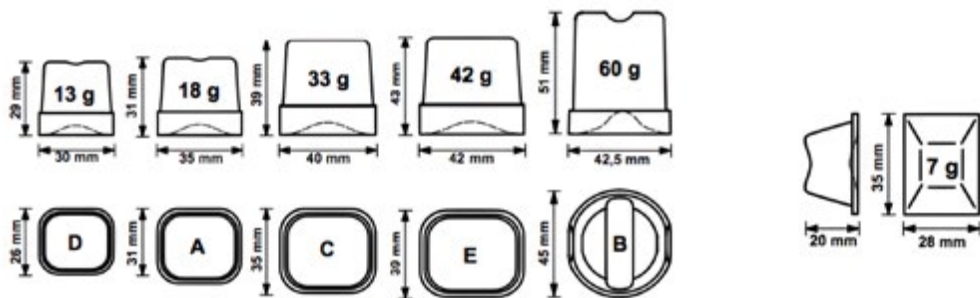

CB 184  
CB 246  
CB 249  
CB 316  
CB 416  
CB 425



CB 640  
CB 840  
CB 955  
CB 1265  
CB 1565



IC 80  
IC 150  
IC 300



IC 18  
IC 24



DSS 42



FRESH MAKER  
ICE WATER 45



VB 250



VM 350  
VM 500  
VM 900  
VM 1700



	ICE IS
Hotéis	●●●●
Restaurantes	●●●●
Fast Foods	●●●●
Bares	●●●●
Discotecas	●●●●

O B-Qube é obtido através do sistema de pulverização clássico com tecnologia moderna e certificação NSF.

B-Qube é um cubo que mantém a alta qualidade, não apenas pela transparência, mas também pela resistência do cubo em si.

Quando usado no shaker não quebra nem derrete e os ângulos permitem uma melhor diluição.



MODELO / MODÈLE / MODELO / MODEL		CB249A HC B-QUBE	CB425A HC B-QUBE	CB640A HC B-QUBE
CÓDIGO / CODE / CÓDIGO / CODE		2116.609	2116.617	2116.619
<b>Preço / Prix / Precio / Price</b>	<b>€</b>	<b>1.852,00</b>	<b>2.339,00</b>	<b>2.983,00</b>
Dimensões / Dimensions / Dimensiones	mm*	390x460x690	500x580x800	738x600x920
Pés / Pieds / Pies / Feet	mm	110/150	110/150	110/150
Capacidade depósito / Capacité depôt / Capacidad deposito / Deposit capacity	kg	9	25	40
Produção de Cubos de gelo / Production cube à glaçon / Producción de Cubos de hielo/ Ice cube production	kg/24h	29	48	72
Tipo de Cubo / Type cube / Tipo Cubos / Ice cube type	gr	23	23	23
Consumo de água / Consommation d'eau / Consumo agua / Cycle Water consumption	lt/kg	5	3	3
Gás refrigerante / Gaz réfrigérant / Gas refrigerante / Refrigerant gas		R290	R290	R290
Peso Líquido-Bruto / Poids Net-Brut / Peso Neto-Bruto / Net-Gross Weight	kg	37/44	56/64	77/89
Potência / Puissance / Potencia / Power	W	320	450	620
Tensão / Tension / Tensión / Tension	V	230	230	230

\* Não inclui a medida dos pés reguláveis de (110-150mm) / Ne comprend pas la mesure des pieds réglables (110-150mm) / No incluye la medida de los pies regulables (110-150mm) / Doesn't include adjustable feet measures (110-150mm)



UDIFRI

**FONTES DE ÁGUA FRIA**  
 FONTAINES EAU FROIDE  
 FUENTES AGUA FRIA  
 COLD WATER SPRINGS



**TORNEIRA TAP**  
**2100.106**  
**52,00**

**Torneira opcional para modelos Spring**  
 Robinet optionnel pour modèles Spring  
 Grifo optativo para modelos Spring  
 Optional tap for Spring models



Revestimento plástico branco  
 Revêtement plast. blanc  
 Recubrimiento plast. blanco  
 White plastic cover

MODELO / MODÈLE / MODELO / MODEL		SPRING C/PUL. PLAS.BR	SPRING C/ PED. PLAS.BR
CÓDIGO / CODE / CÓDIGO / CODE		2100.100	2100.101
<b>Preço / Prix / Precio / Price</b>	<b>€</b>	<b>1.359,00</b>	<b>1.420,00</b>
Dimensões / Dimensions / Dimensiones	mm	320x320x970	320x320x970
Temperatura / Température / Temperatura / Temperature	°C	+8	+8
Produção horária / Prod, horaire / Prod, hora / Hourly prod.	lt/h	18	18
Peso Bruto / Poids Brut / Peso Bruto / Gross Weight	kg	30	30
Potência / Puissance / Potência / Power	w	125	125
Tensão / Tension / Tension / Tension	V	230	230



MODELO / MODÈLE / MODELO / MODEL		SPRING C/ PED. INOX	SPRING C/ PUL. INOX
CÓDIGO / CODE / CÓDIGO / CODE		2100.102	2100.102A
<b>Preço / Prix / Precio / Price</b>	<b>€</b>	<b>1.482,00</b>	<b>1.420,00</b>
Dimensões / Dimensions / Dimensiones	mm	320x320x970	320x320x970
Temperatura / Température / Temperatura / Temperature	°C	+8	+8
Produção horária / Prod, horaire / Prod, hora / Hourly prod.	lt/h	18	18
Peso Bruto / Poids Brut / Peso Bruto / Gross Weight	kg	30	30
Potência / Puissance / Potência / Power	W	125	125
Tensão / Tension / Tension / Tension	V	230	230



MODELO / MODÈLE / MODELO / MODEL		KSLIM PRIA AMBIENTE*
CÓDIGO / CODE / CÓDIGO / CODE		2100.110
<b>Preço / Prix / Precio / Price</b>	<b>€</b>	<b>446,00</b>
Dimensões / Dimensions / Dimensiones	mm	340x340x950
Volume tanque / Volume / Volume / Volume	it	4
Temperatura / Température / Temperatura / Temperature	°C	+5/+10
Produção horária / Prod, horaire / Prod, hora / Hourly prod.	lt/h	3
Peso Bruto / Poids Brut / Peso Bruto / Gross Weight	kg	17
Potência / Puissance / Potência / Power	W	85
Tensão / Tension / Tension / Tension	V	230



 **confirmar disponibilidade**  
 confirmer la disponibilité  
 confirmar la disponibilidad  
 confirm the availability

\*Fora de produção. Consulte-nos para obter alternativa / Hors production. Contactez-nous pour une solution de rechange / Fuera de producción. Contáctenos para obtener una alternativa / Out of production. Contact us for alternative /

Interior e exterior em aço inoxidável AISI 304  
Pés ajustáveis  
Termostato eletrónico  
Espessura de isolamento 60mm

Intérieur et extérieur en acier inox AISI 304  
Pieds réglables  
Thermostat électronique  
Isolation épaisseur 60mm

Interior y exterior en acero inoxidable AISI 304  
Pies ajustables  
Termostato electrónico  
Espesor del aislamiento 60 mm

Interior and exterior in stainless steel AISI 304  
Adjustable feet  
Electronic thermostat  
Insulation thickness 60mm

**ABATEDOR 3**



**NOVO  
NOUVEAU  
NUEVO  
NEW**

**ABATEDOR 3**



**ABATEDOR 5**



**ABATEDOR 10**



**ABATEDOR 15**



**NOVO  
NOUVEAU  
NUEVO  
NEW**

MODELO / MODÈLE / MODELO / MODEL CÓDIGO / CODE / CÓDIGO / CODE		ABATEDOR 3 NÍVEIS 2/3GN 2930.801	ABATEDOR 3 NÍVEIS 2930.803	ABATEDOR 5 NÍVEIS 2930.805
<b>Preço / Prix / Precio / Price</b>	€	<b>2.220,00</b>	<b>2.760,00</b>	<b>3.205,00</b>
Dimensões Exteriores / Dim.Ext. / Dim. Ext. / Ext. Dim.	mm	660x640x420	750x740x750 /780	750x740x870 /900
Dimensões Interiores / Dim. Int. / Dim. Int. / Ext. Dim.	mm	340x363x270	610x410x280	610x410x410
Cap.e Tabuleiros / Cap. Plateaux / Cap. Bandejas / Tray Cap.	nr	3x 2/3GN	3x 1/1GN (60x40)	5x 1/1GN (60x40)
Temperatura Arrefecimento / Temp. Refroid. / Temp. Enfriamiento / Cooling Temp.	°C	+3/-18/-40	+3/-18	+3/-18
Cap.e Arrefecimento / Cap. Refroid. / Cap. Enfriamiento / Cooling Cap.	90° °C	+70°C > +3 (9kg)	+70 > +3 (15kg)	+70 > +3 (23kg)
Cap.e Congelação / Cap. Congélation / Cap. Congelación / Freezing Cap.	240° °C	+70°C > -18 (7kg)	+70 > -18 (9kg)	+70 > -18 (12kg)
Temperatura Operação / Temp. D'utilisation / Temperatura Operación / Operating Temp.	°C	+30	+43	+43
Gás Refrigerante / Gaz Réfrigérant / Gas Refrigerante / Refrigerating Gas		R452A	R404A	R404A
Espaço entre Tabuleiros / Espace Étagères / Espacio Estantes / Space Between Shelves	mm	80	70	70
Peso Líquido / Poids Net / Peso Neto / Net Weight	Kg	45	82	92
Potência / Puissance / Potencia / Power	W	550	1150	1424
Tensão / Tension / Tensión / Tension	V	230	230	230

MODELO / MODÈLE / MODELO / MODEL CÓDIGO / CODE / CÓDIGO / CODE		ABATEDOR 10 NÍVEIS 2930.809
<b>Preço / Prix / Precio / Price</b>	€	<b>5.215,00</b>
Dimensões Exteriores / Dim.Ext. / Dim. Ext. / Ext. Dim.	mm	750x740x1300 /1320
Dimensões Interiores / Dim. Int. / Dim. Int. / Ext. Dim.	mm	610x410x760
Cap.e Tabuleiros / Cap. Plateaux / Cap. Bandejas / Tray Cap.	nr	10x 1/1GN (60x40)
Temperatura Arrefecimento / Temp. Refroid. / Temp. Enfriamiento / Cooling Temp.	°C	+3/-18
Cap.e Arrefecimento / Cap. Refroid. / Cap. Enfriamiento / Cooling Cap.	90° °C	+70 > +3 (25kg)
Cap.e Congelação / Cap. Congélation / Cap. Congelación / Freezing Cap.	240° °C	+70 > -18 (15kg)
Temperatura Operação / Temp. D'utilisation / Temperatura Operación / Operating Temp.	°C	+43
Gás Refrigerante / Gaz Réfrigérant / Gas Refrigerante / Refrigerating Gas		R404A
Espaço entre Tabuleiros / Espace Étagères / Espacio Estantes / Space Between Shelves	mm	70
Peso Líquido / Poids Net / Peso Neto / Net Weight	Kg	112
Potência / Puissance / Potencia / Power	W	1490
Tensão / Tension / Tensión / Tension	V	230

MODELO / MODÈLE / MODELO / MODEL CÓDIGO / CODE / CÓDIGO / CODE		ABATEDOR 15 NÍVEIS 2930.812
<b>Preço / Prix / Precio / Price</b>	€	<b>8.950,00</b>
Dimensões Exteriores / Dim.Ext. / Dim. Ext. / Ext. Dim.	mm	750x750x1850 /1870
Dimensões Interiores / Dim. Int. / Dim. Int. / Ext. Dim.	mm	610x410x1120
Cap.e Tabuleiros / Cap. Plateaux / Cap. Bandejas / Tray Cap.	nr	15x1/1GN (60x40)
Temperatura Arrefecimento / Temp. Refroid. / Temp. Enfriamiento / Cooling Temp.	°C	+3/-18
Cap.e Arrefecimento / Cap. Refroid. / Cap. Enfriamiento / Cooling Cap.	90° °C	+70 > +3 (45kg)
Cap.e Congelação / Cap. Congélation / Cap. Congelación / Freezing Cap.	240° °C	+70 > -18 (25kg)
Temperatura Operação / Temp. D'utilisation / Temperatura Operación / Operating Temp.	°C	+43
Gás Refrigerante / Gaz Réfrigérant / Gas Refrigerante / Refrigerating Gas		R452A
Espaço entre Tabuleiros / Espace Étagères / Espacio Estantes / Space Between Shelves	mm	70
Peso Líquido / Poids Net / Peso Neto / Net Weight	Kg	120
Potência / Puissance / Potencia / Power	W	2400
Tensão / Tension / Tensión / Tension	V	380



UDIfri

**ABATEDORES**  
CELLULES DE REFRIGÉRISSMENT  
ABATIDORES  
BLAST CHILLERS



**ABM-S 061S**

Estrutura externa em aço inoxidável AISI 304 Scotch-Brite acetinado, com pés ajustáveis.  
Isolamento 60 mm de espessura, densidade de 40 kg/m<sup>3</sup>, poliuretano injectado livre de CFC e HCFC.  
Câmara de abatimento em AISI 304 2B, com cantos internos arredondados, fundo inclinado com dreno,



**ABM-S 061S**

Structure extérieure en acier inoxydable AISI 304  
Scotch-Brite satiné, avec pieds réglables.  
Isolation épaisseur 60 mm, densité 40 kg / m<sup>3</sup>, polyuréthane injecté sans CFC ni HCFC.  
Cellule de refroidissement en AISI 304 2B, avec coins internes arrondis, fond incliné avec drainage, permet évacuation des condensats et eau de lavage.



**ABM-S 061S**

Estructura externa en acero inoxidable satinado AISI 304 Scotch-Brite, con patas ajustables.  
Aislamiento de 60 mm de espesor, densidad 40 kg / m<sup>3</sup>, poliuretano inyectado libre de CFC y HCFC.  
La cámara de asentamiento AISI 304 2B, con cantos internos redondeadas, fondo inclinado con drenaje, permite un fácil drenaje de condensados y agua de lavado.



**ABM-S 061S**

External structure in AISI 304 Scotch-Brite satin stainless steel, with adjustable feet.  
Insulation 60 mm thick, density 40 kg / m<sup>3</sup>, injected polyurethane free of CFC and HCFC.  
AISI 304 2B slump chamber, with rounded internal corners, sloped bottom with drain, allows easy condensate drainage and washing water.



1/1GN



MODELO / MODÈLE / MODELO / MODEL	ABM-S 061S	
CÓDIGO / CODE / CÓDIGO / CODE	2128.904	
<b>Preço / Prix / Precio / Price</b>	<b>€</b>	<b>5.740,00</b>
Dimensões / Dimensions / Dimensiones	mm	780x700x1450
Dimensões Internas / Dimensions Int. / Dimensiones Int. / Int. dimensions	mm	660x400x613
Gás refrigerante / Gaz réfrigérant / Gas refrigerante / Refrigerating gas		R404A
Grelhas / Étagères / Estantes / Shelves	nr	6X1/1GN
Espaço Tabuleiros / Espace Étagères / Espacio Estantes / Space Between Shelves	mm	85
Ciclo de abatimento / Cycle réfrigération Ciclo refrigeración / Chilling cycle	©90° 90°C > +3°C kg	21,6
Ciclo de congelação / Cycle congélation Ciclo congelamiento / Freezing cycle	©240° 90°C > 18°C kg	14,4
Peso Líquido-Bruto / Poids Net-Brut / Peso Neto-Bruto / Net-Gross Weight	kg	110-
Potência / Puissance / Potência / Power	W	2080
Potência frigorífica / Puissance frigorifique / Potência frigorífica / Refrigerating Power	W	1190
Tensão / Tension / Tensión / Tension	V	230



MODELO / MODÈLE / MODELO / MODEL	ABATEDOR MISTO ST15-40	
CÓDIGO / CODE / CÓDIGO / CODE	2187.201	
<b>Preço / Prix / Precio / Price</b>	<b>€</b>	<b>11.378,00</b>
Dimensões Exteriores / Dim.Ext. / Dim. Ext. / Ext. Dim.	mm	800x800x1950-2005
Cap.e Tabuleiros / Cap. Plateaux / Cap. Bandejas / Tray Cap.	nr	15x 1/1GN (60x40)
Cap.e Arrefecimento / Cap. Refroid. / Cap. Enfriamento / Cooling Cap.	90° °C	+90/+3 (40kg)
Cap.e Congelação / Cap. Congélation / Cap. Congelación / Freezing Cap.	240° °C	+90/-18 (28kg)
Gás Refrigerante / Gaz Réfrigérant / Gas Refrigerante / Refrigerating Gas		R404A
Espaço Tabuleiros / Espace Étagères / Espacio Estantes / Space Between Shelves	mm	68
Peso Líquido-Bruto / Poids Net-Brut/ Peso Neto-Bruto / Net-Gross Weight	Kg	185-200
Potência / Puissance / Potência / Power	W	2700
Tensão / Tension / Tensión / Tension	V	400



confirmar disponibilidade  
confirmer la disponibilité  
confirmar la disponibilidad  
confirm the availability



MODELO / MODÈLE / MODELO / MODEL	TF72S	
CÓDIGO / CODE / CÓDIGO / CODE	2186.337A	
<b>Preço / Prix / Precio / Price</b>	€	<b>15.779,00</b>
Dimensões / Dimensions / Dimensiones	mm	1040x1010x1990
Temperatura Ambiente / Temp.Ambiente / Temp. Ambiente / Room Temp.	°C	+32
Gás refrigerante / Gaz réfrigérant / Gas refrigerante / Refrigerating gas		R404A
Refrigeração / Réfrigération / Refrigeración / Cooling	AR/GQ**	AR
Descongelamento / Décongélation / Descong. / Defrosting	M/A*	-
Grelhas / Étagères / Estantes / Shelves	nr	10 GN 2/1
Espessura Isolamento / Epaisseur d'isolation / Espesor de aislamiento / Isolation thickness	mm	75
Ciclo de abatimento / Cycle réfrigération Ciclo refrigeración / Chilling cycle	©90' 90°C > +3°C kg	70
Ciclo de congelação/Cycle congélation Ciclo congelamiento / Freezing cycle	©240' 90°C > 18°C kg	35
Peso Líquido-Bruto /Poids Net-Brut /Peso Neto-Bruto /Net-Gross Weight	kg	235/255
Potência / Puissance / Potência / Power	kW	5
Tensão / Tension / Tension / Tension	V	400



MODELO / MODÈLE / MODELO / MODEL	IM101L	
CÓDIGO / CODE / CÓDIGO / CODE	2186.240	
<b>Preço / Prix / Precio / Price</b>	€	<b>12.233,00</b>
Dimensões / Dimensions / Dimensiones	mm	800x830x1750
Temperatura Ambiente / Température Ambiente / Temperatura Ambiente / Room Temperature	°C	+32
Gás refrigerante / Gaz réfrigérant / Gas refrigerante / Refrigerating gas		R404A
Refrigeração / Réfrigération / Refrigeración / Cooling	AR/GQ**	AR
Grelhas / Étagères / Estantes / Shelves	nr	10 GN1/1 (60X40)
Espessura Isolamento / Epaisseur d'isolation / Espesor de aislamiento / Isolation thickness	mm	75
Ciclo de abatimento / Cycle réfrigération Ciclo refrigeración / Chilling cycle	©90' 90°C > +3°C kg	42
Ciclo de congelação/Cycle congélation Ciclo congelamiento / Freezing cycle	©240' 90°C > 18°C kg	25
Peso Líquido-Bruto /Poids Net-Brut /Peso Neto-Bruto /Net-Gross Weight	kg	195/220
Potência / Puissance / Potência / Power	kW	3,2
Tensão / Tension / Tension / Tension	V	400



MODELO / MODÈLE / MODELO / MODEL	ELECTRÓNICO IM102S	
CÓDIGO / CODE / CÓDIGO / CODE	2186.259	
<b>Preço / Prix / Precio / Price</b>	€	<b>15.359,00</b>
Dimensões / Dimensions / Dimensiones	mm	1040x1000x1880
Gás refrigerante / Gaz réfrigérant / Gas refrigerante / Refrigerating gas		R404A
Grelhas / Étagères / Estantes / Shelves	nr	10 x 2/1 GN (60X80)
Ciclo de abatimento / Cycle réfrigération Ciclo refrigeración / Chilling cycle	©90' 90°C > +3°C kg	100
Ciclo de congelação/Cycle congélation Ciclo congelamiento / Freezing cycle	©240' 90°C > 18°C kg	50
Peso Líquido-Bruto /Poids Net-Brut /Peso Neto-Bruto /Net-Gross Weight	kg	270
Potência / Puissance / Potência / Power	kW	5,5
Tensão / Tension / Tension / Tension	V	400

\*V = Ventilada / Ventilé / Ventilada / Ventilated | S = Estática / Static / Estática / Static  
\*\*AR - Ar / Aire / Aire / Air | GQ - Gás Quente / Gaz Chaud / Gas Caliente / Hot Gas

# = + 103 - 135 mm - Pés reguláveis / Pieds réglables / Pies regulables / adjustable feet

**Tabuleiros e Grelhas não incluídos**  
**Plateaux et Grilles non inclus**  
**Bandejas y rejillas no incluidas**  
**Trays and griddles not included**



**SAGI**

**ABATEDORES / CONGELADORES**  
 CELLULES DE REFROIDISSEMENT / CONGÉLATION  
 ABATIDORES / CONGELADORES  
 BLAST CHILLERS / FREEZERS



Painel LCD  
 Inúmeros programas automáticos  
 Sonda multiponto  
 Barra LED RGB de progresso  
 Alarme HACCP  
 Aço Inoxidável AISI 304  
 Fechadura  
 Sem grupo (ver opcional)



Écran LCD  
 Nombreux programmes automatiques  
 Sonde multipoint  
 Barre de progression LED RGB  
 Alarme HACCP  
 Acier inoxydable AISI 304  
 Serrure  
 Sans groupe (voir optionnel)



Panel LCD  
 Numerosos programas automáticos  
 Sonda multipunto  
 Barra de progreso LED RGB  
 Alarme HACCP  
 El acero inoxidable AISI 304  
 Cerradura  
 Sin grupo (ver opcional)



LCD panel  
 Numerous automatic programs  
 Multipoint probe  
 LED RGB progress bar  
 HACCP alarm  
 Stainless steel AISI 304  
 Door lock  
 No group (check optional)



MODELO / MODÈLE / MODELO / MODEL	IFR201R 20 1/1	
CÓDIGO / CODE / CÓDIGO / CODE	2186.338	
<b>Preço / Prix / Precio / Price</b>	€	<b>24.509,00</b>
Dimensões / Dimensions / Dimensiones	mm	1050x1250x2260
Descongelção / Décongélation / Descong. / Defrosting	M/A**	A
Espessura Isolamento / Epaisseur d'isolation / Espesor de aislamiento / Isolation thickness	mm	80
Ciclo de abatimento / Cycle réfrigération Ciclo refrigeración / Chilling cycle	©90' 90°C »+3°C kg	120
Ciclo de congelação/ Cycle congélation Ciclo congelamiento / Freezing cycle	©240' 90°C-> 18°C kg	72
Peso Líquido-Bruto / Poids Net-Brut / Peso Neto-Bruto / Net-Gross Weight	kg	280/380
Potência / Puissance / Potência / Power	W	3000
Tensão / Tension / Tension / Tension	V	400



MODELO / MODÈLE / MODELO / MODEL	IFR202R 20 2/1	
CÓDIGO / CODE / CÓDIGO / CODE	2186.342	
<b>Preço / Prix / Precio / Price</b>	€	<b>30.795,00</b>
Dimensões / Dimensions / Dimensiones	mm	1400x1250x2260
Descongelção / Décongélation / Descong. / Defrosting	M/A**	A
Espessura Isolamento / Epaisseur d'isolation / Espesor de aislamiento / Isolation thickness	mm	80
Ciclo de abatimento / Cycle réfrigération Ciclo refrigeración / Chilling cycle	©90' 90°C »+3°C kg	210
Ciclo de congelação/ Cycle congélation Ciclo congelamiento / Freezing cycle	©240' 90°C-> 18°C kg	144
Peso Líquido-Bruto / Poids Net-Brut / Peso Neto-Bruto / Net-Gross Weight	kg	360/500
Potência / Puissance / Potência / Power	W	4500
Tensão / Tension / Tension / Tension	V	400



MODELO / MODÈLE / MODELO / MODEL	IFP202R 20 2/1 PASSANTE	
CÓDIGO / CODE / CÓDIGO / CODE	2186.344	
<b>Preço / Prix / Precio / Price</b>	€	<b>32.728,00</b>
Dimensões / Dimensions / Dimensiones	mm	1400x1250x2260
Descongelção / Décongélation / Descong. / Defrosting	M/A**	A
Espessura Isolamento / Epaisseur d'isolation / Espesor de aislamiento / Isolation thickness	mm	80
Ciclo de abatimento / Cycle réfrigération Ciclo refrigeración / Chilling cycle	©90' 90°C »+3°C kg	210
Ciclo de congelação/ Cycle congélation Ciclo congelamiento / Freezing cycle	©240' 90°C-> 18°C kg	144
Peso Líquido-Bruto / Poids Net-Brut / Peso Neto-Bruto / Net-Gross Weight	kg	410/550
Potência / Puissance / Potência / Power	W	4500
Tensão / Tension / Tension / Tension	V	400

**Tabuleiros e Grelhas não incluídos**  
**Plateaux et Grilles non inclus**  
**Bandejas y rejillas no incluidas**  
**Trays and griddles not included**

Cód.	OPCIONAL / OPTIONAL	€
2186.320	GRUPO FRIGORIFICO GR14A P/IMR202R-IMP202R	<b>15.565,00</b>
2186.330	GRUPO FRIGORIFICO GR7A P/IMR201R	<b>13.182,00</b>

\*\*A - Automático / Automatique / Automatico / Automatic - M - Manual / Manuel / Manual / Manual | (AR - Ar / Aire / Aire / Air | GQ - Gás Quente / Gaz Chaud / Gas Caliente / Hot Gas)  
 Unidade remota até 25m de distância com GR7A, GR14A / Unité de distance jusqu'à 25 m avec GR7A, GR14A / Unidad remota hasta de 25 m con GR7A, GR14A / Remote unit up to 25 m away with GR7A, GR14A.

Abatedor carrelado misto  
Com unidade de condensação  
**Capacidade 1 Carro (não incluído)**  
**GN2/1 ou GN1/1 ou 600x800mm**  
Descongelação através de gás quente e ventilação forçada.

Célules Refroidissements combiné  
Avec unité de condensation  
**Capacité 1 Charriot (non incluse)**  
**GN2/1 ou GN1/1 ou 600x800mm**  
Dégivrage par gaz chaud et ventilation forcée

Abatidores de temperatura mixtos  
Con unidad de condensación  
**Capacidad 1 Carro no incluído GN2/1 o GN1/1 o 600x800mm**  
Descongelación a través de gas caliente y ventilación forzada

Combined blast chiller  
With condensation unit  
**Capacity 1 Trolley not included GN2/1 or GN1/1 or 600x800mm**  
Defrosting through hot gas and forced ventilation

**2187.204**  
Com Grupo Incorporado

**2187.204**  
Avec Groupe Incorporé

**2187.204**  
Con Grupo incorporado

**2187.204**  
With Incorporated Group

**2187.206 / 2187.208**  
Grupo compresor à distância máxima de 15 metros.

**2187.206 / 2187.208**  
Groupe de compresseurs avec une distance maximale de 15 mètres

**2187.206 / 2187.208**  
Grupo compresor a distancia máxima de 15 metros

**2187.206 / 2187.208**  
Compressor group with a maximum distance of 15 meters.

**2187.214**  
Sem grupo compresor

**2187.214**  
Sem grupo compresor

**2187.214**  
Sin grupo compresor

**2187.214**  
Without compressor group

Cód.	Ref.	P/ Modelo	€
2187.210	Esterilizador de ozono Stérilisateur à l'ozone Esterilizador de ozono Ozone Sterilizer	E-20-80 e T20	968,00
2187.218	Painéis desmontáveis Panneaux pliables Paneles desmontables Removable panels		789,00
2187.306	Carro Inox p/ 20 tab./plateaux/tray Charriot Acier Inox p/ 20 tab./plateaux/tray Carro Acero Inox p/ 20 tab./plateaux/tray Trolley Stainless Steel p/ 20 tab./plateaux/tray	600X800mm	CONSULTAR
2187.310	Carro Inox p/ 18 tab./plateaux/tray Charriot Acier Inox p/ 18 tab./plateaux/tray Carro Acero Inox p/ 18 tab./plateaux/tray Trolley Stainless Steel p/ 18 tab./plateaux/tray	GN 1/1	CONSULTAR
2187.314	Carro Inox p/ 18 tab./plateaux/tray Charriot Acier Inox p/ 18 tab./plateaux/tray Carro Acero Inox p/ 18 tab./plateaux/tray Trolley Stainless Steel p/ 18 tab./plateaux/tray	GN 2/1	CONSULTAR



MODELO / MODÈLE / MODELO / MODEL	UDIE20-80	UDIE20-80RE	UDIE20-110RE	UDIE20-80RE-110RE S/GRUPO
CÓDIGO / CODE / CÓDIGO / CODE	2187.204	2187.206	2187.208	2187.214
<b>Preço / Prix / Precio / Price</b>	<b>€ 26.158,00</b>	<b>30.002,00</b>	<b>32.345,00</b>	<b>18.812,00</b>
Dimensões / Dimensions / Dimensiones	mm 890x1440x2410	890x1440x2410	890x1440x2410	890x1440x2410
Dimensões Carro / Dimensions Charriot / Dimensiones Carro / Trolley Dimensions	mm 680x860x1860	680x860x1860	680x860x1860	680x860x1860
Espessura Isolamento / Epaisseur d' isolation / Espesor de aislamiento / Isolation Thickness	mm 70	70	70	70
Descongelação / Décongélation / Descong. / Defrosting	M/A A =Gás Quente/ Hot Gas	A =Gás Quente/ Hot Gas	A =Gás Quente/ Hot Gas	A =Gás Quente/ Hot Gas
Gas refrigerante / Gaz réfrigérant / Gas refrigerante / Refrig. Gas	R 452a	R 452a	R 452a	R 452a
Ciclo de abatimento / Cycle réfrigération / Ciclo refrigeración / Chilling cycle	(+90°/+3°C/ kg) 80	80	110	80
Ciclo de congelação / Cycle congélation / Ciclo congelamiento / Freezing cycle	(+90°/-18°C/ kg) 65	65	95	65
Peso Líquido-Bruto / Poids Net-Brut / Peso Neto-Bruto / Net-Gross Weight	kg 353-430	255-332	255-332	255-332
Potência / Puissance / Potência / Power	W 3900	475+3425	475+3900	3900
Potência frigorífica / Puissance frigorifique / Potência frigorífica / Refrigerating Power	W 5400	5400	7270	-
Tensão / Tension / Tensión / Tension	V 400	400	400	400



UDI  
fri

**ABATEDORES - CARRELADOS**  
CELLULES DE REFRROIDISSEMENT - CHARRIOT  
ABATIDORES - CARRO  
BLAST CHILLERS - TROLLEY



**Modelos UDIT20-C+**  
Abatedores de temperatura carrelados mistos  
Com grupo à distância e kit de instalação até 10 metros  
**Capacidade 1 Carro não incluído GN1/1**  
Descongelação através de gás quente e ventilação forçada  
Equipamento em aço inox AISI 304



**Modèles UDIT20-C+**  
Cellules Refroidissements combiné mixte  
Avec groupe à distance et kit d'installation jusqu'à 10 mètres  
**Capacité 1 Charriot (non incluse) GN1/1**  
Dégivrage par gaz chaud et ventilation forcée  
Equipement en acier inoxydable AISI 304



**Modelos UDIT20-C+**  
Abatedores de temperatura cargados mistos  
Con grupo a distancia y kit de instalación hasta 10 metros  
**Capacidad 1 Carro no incluído GN1/1**  
Descongelación a través de gas caliente y ventilación forzada  
Equipamiento en acero inoxidable AISI 304



**UDIT20-C+ Units**  
Combined blast chiller  
With remote group and installation kit up to 10 meters  
**Capacity 1 Trolley not included GN1/1**  
Defrosting through hot gas and forced ventilation  
AISI 304 stainless steel equipment

**2187.220 / 2187.222 / 2187.232 / 2187.234**  
Grupo compressor à distância máxima de 10 metros.

**2187.220 / 2187.222 / 2187.232 / 2187.234**  
Groupe de compresseurs avec une distance maximale de 10 mètres

**2187.220 / 2187.222 / 2187.232 / 2187.234**  
Grupo compressor a distancia máxima de 10 metros

**2187.220 / 2187.222 / 2187.232 / 2187.234**  
Compressor group with a maximum distance of 10 meters.

**2187.228 / 2187.236**  
Sem grupo compressor

**2187.228 / 2187.236**  
Sem grupo compressor

**2187.228 / 2187.236**  
Sin grupo compressor

**2187.228 / 2187.236**  
Without compressor group

Cód.	Ref.	P/ Modelo	€
2187.224	Kit Adicional de Instalação (metro) Kit d'installation supplémentaire (mètre) Kit adicional de instalación (metro) Additional Installation Kit (meter)		103,00
2187.226	Suplemento para condensador a água Supplément pour condenseur d'eau Suplemento para condensador de agua Water condenser supplement		1.020,00
2187.230	Grupo com isolamento acústico Groupe avec isolation phonique Grupo con aislamiento acústico Group with sound insulation	T20-C+/80-110	4.936,00

Carros compatíveis com Fornos Rational\*\* e Convotherm\*  
Charriots compatibles avec fours Rational\*\* et Convotherm\*  
Carros compatibles con hornos Rational\*\* y Convotherm\*  
Trolleys compatible with Rational\*\* and Convotherm\* Ovens



MODELO / MODÈLE / MODELO / MODEL		UDIT20-C+ / 80-AÇO INOX	UDIT20-C+ / 110-AÇO INOX	UDIT20-C+ / 80 S/ GRUPO- AÇO INOX	UDIT20-R/80-AÇO INOX	UDIT20-R/110-AÇO INOX	UDIT20-R/80-110 S/ GRUPO-AÇO INOX
CÓDIGO / CODE / CÓDIGO / CODE		2187.220	2187.222	2187.228	2187.232	2187.234	2187.236
<b>Preço / Prix / Precio / Price</b>	<b>€</b>	<b>33.490,00</b>	<b>35.082,00</b>	<b>21.549,00</b>	<b>33.490,00</b>	<b>35.082,00</b>	<b>21.549,00</b>
Dimensões / Dimensions / Dimensiones	mm	1040X962X2275 (2040+235)	1040X962X2275 (2040+235)	1040X962X2275 (2040+235)	1040X880X2275 (2040+235)	1040X880X2275 (2040+235)	1040X880X2275 (2040+235)
Dimensões Carro / Dimensions Charriot / Dimensiones Carro / Trolley Dimensions	mm	Convotherm Trolley 20.10*	Convotherm Trolley 20.10*	Convotherm Trolley 20.10*	Trolley201**	Trolley201**	Trolley201**
Espessura Isolamento / Epaisseur d'isolation / Espesor de aislamiento / Isolation Thickness	mm	85	85	85	85	85	85
Descongelação / Décongélation / Descong. / Defrosting	M/A	A =Gás Quente/ Hot Gas	A =Gás Quente/ Hot Gas	A =Gás Quente/ Hot Gas	A =Gás Quente/ Hot Gas	A =Gás Quente/ Hot Gas	A =Gás Quente/ Hot Gas
Gas refrigerante / Gaz réfrigérant / Gas refrigerante / Refrig. Gas		R 452a	R 452a	R 452a	R 452a	R 452a	R 452a
Ciclo de abatimento / Cycle réfrigération / Ciclo refrigeración / Chilling cycle	(+90°/+3°C/ Kg)	80	110	80	80	110	80-110
Ciclo de congelação / Cycle congélation / Ciclo congelamiento / Freezing cycle	(+90°/-18°C/ kg)	65	95	65	65	95	65-95
Peso Líquido-Bruto / Poids Net-Brut / Peso Neto-Bruto / Net-Gross Weight	kg	-/340	-/340	-/340	-/340	-/340	-/340
Potência / Puissance / Potência / Power	W	3600	4200	3600	3600	4200	3600
Potência frigorífica / Puissance frigorifique / Potência frigorífica / Refrigerating Power	W	6500	8150	-	6500	8150	-
Tensão / Tension / Tensión / Tension	V	400	400	400	400	400	400

 Abatedores de temperatura carrelados mistos  
Com grupo à distância e kit de instalação até 10 metros  
**Capacidade 1 Carro (não incluído) GN2/1 ou 600x800mm ou 2x 600x400mm**  
Descongelação através de gás quente e ventilação forçada  
Equipamento em aço inox AISI 304  
Com isolamento de pavimento 70

 Célules Refroidissements combiné mixte  
Avec groupe à distance et kit d'installation jusqu'à 10 mètres  
**Capacité 1 Charriot (non incluse) GN2/1 ou 600x800mm ou 2x 600x400mm**  
Dégivrage par gaz chaud et ventilation forcée  
Équipement en acier inoxydable AISI 304  
Avec isolation de sol 70mm

 Abatidores de temperatura cargados mixtos  
Con grupo a distancia y kit de instalación hasta 10 metros  
**Capacidad 1 Carro (no incluido) GN2/1 ou 600x800mm o 2x 600x400mm**  
Descongelación a través de gas caliente y ventilación forzada  
Equipamiento en acero inoxidable AISI 304  
Con aislamiento del piso 70

 Combined blast chiller  
With remote group and installation kit up to 10 meters  
**Capacity 1 Trolley (not included) GN2/1 ou 600x800mm or 2x 600x400mm**  
Defrosting through hot gas and forced ventilation  
AISI 304 stainless steel equipment  
With floor insulation 70

**2187.240 / 2187.242**  
Grupo compressor à distância máxima de 10 metros.

**2187.240 / 2187.242**  
Groupe de compresseurs avec une distance maximale de 10 mètres

**2187.240 / 2187.242**  
Grupo compressor a distancia máxima de 10 metros

**2187.240 / 2187.242**  
Compressor group with a maximum distance of 10 meters.

**2187.250**  
Sem grupo

**2187.250**  
Sans groupe

**2187.250**  
Sin grupo

**2187.250**  
Without group

Cód.	Ref.	P/ Modelo	€
2187.244	Esterilizador de ozono Stérilisateur à l'ozone Esterilizador de ozono Ozone Sterilizer	T30 - T50	1.655,00
2187.248	Suplemento condensador a água Supplément de condenseur d'eau Suplemento condensador a agua Water Condenser Supplement	T30	1.694,00
2187.252	Porta adicional (Túnel) Porte supplémentaire (Tunnel) Puerta adicional (Túnel) Additional Door (Tunnel)	T30/110-140	4.137,00
2187.302	Carro Inox p/ 20 tab./plateaux/tray Charriot Acier Inox p/ 20 tab./plateaux/tray Carro Acero Inox p/ 20 tab./plateaux/tray Trolley Stainless Steel p/ 20 tab./plateaux/tray	600x400mm	CONSULTAR
2187.306	Carro Inox p/ 20 tab./plateaux/tray Charriot Acier Inox p/ 20 tab./plateaux/tray Carro Acero Inox p/ 20 tab./plateaux/tray Trolley Stainless Steel p/ 20 tab./plateaux/tray	600X800mm	CONSULTAR
2187.314	Carro Inox p/ 18 tab./plateaux/tray Charriot Acier Inox p/ 18 tab./plateaux/tray Carro Acero Inox p/ 18 tab./plateaux/tray Trolley Stainless Steel p/ 18 tab./plateaux/tray	GN 2/1	CONSULTAR



MODELO / MODÈLE / MODELO / MODEL		UDIT30/110- AÇO INOX	UDIT30/140-AÇO INOX	UDIT30-110-140 S/ GRUPO-AÇO INOX
CÓDIGO / CODE / CÓDIGO / CODE		2187.240	2187.242	2187.250
<b>Preço / Prix / Precio / Price</b>	<b>€</b>	<b>39.970,00</b>	<b>46.641,00</b>	<b>23.459,00</b>
Dimensões / Dimensions / Dimensiones	mm	1415x1225x2360	1415x1225x2360	1415x1225x2360
Dimensões Carro / Dimensions Charriot / Dimensiones Carro / Trolley Dimensions	mm	600X800	600X800	600X800
Espessura Isolamento / Epaisseur d' isolation / Espesor de aislamiento / Isolation Thickness	mm	70	70	70
Descongelação / Décongélation / Descong. / Defrosting	M/A	A =Gás Quente/ Hot Gas	A =Gás Quente/ Hot Gas	A =Gás Quente/ Hot Gas
Gas refrigerante / Gaz réfrigérant / Gas refrigerante / Refrig. Gas		R 452a	R 452a	R 452a
Ciclo de abatimento / Cycle réfrigération / Ciclo refrigeración / Chilling cycle	(+90°/+3°C/ Kg)	110	140	110-140
Ciclo de congelação / Cycle congélation / Ciclo congelamiento / Freezing cycle	(+90°/-18°C/ Kg)	95	125	95-125
Peso Líquido-Bruto / Poids Net-Brut / Peso Neto-Bruto / Net-Gross Weight	kg	-/450	-/450	-/340
Potência / Puissance / Potência / Power	W	5700	6500	5700
Potência frigorífica / Puissance frigorifique / Potência frigorífica / Refrigerating Power	W	8310	10970	-
Tensão / Tension / Tensión / Tension	V	400	400	400



UDIfri

**ABATEDORES - CARRELADOS**  
CELLULES DE REFRROIDISSEMENT - CHARRIOT  
ABATIDORES - CARRO  
BLAST CHILLERS - TROLLEY



Abatedores de temperatura carrelados mistos  
Com grupo à distância e kit de instalação até 10 metros  
**Capacidade 1 Carro (não incluído) GN2/1 ou 600x1000mm**  
Descongelação através de gás quente e ventilação forçada  
Equipamento em aço inox AISI 304  
Com pavimento isolante 70



Céllules Refroidissements combiné mixte  
Avec groupe à distance et kit d'installation jusqu'à 10 mètres  
**Capacité 1 Charriot (non incluse) GN2/1 ou 600x1000mm**  
Dégivrage par gaz chaud et ventilation forcée  
Équipement en acier inoxydable AISI 304  
Avec isolation de sol 70mm



Abatidores de temperatura cargados mixtos  
Con grupo a distancia y kit de instalación hasta 10 metros  
**Capacidad 1 Carro (no incluido) GN2/1 ou 600x1000mm**  
Descongelación a través de gas caliente y ventilación forzada  
Equipamiento en acero inoxidable AISI 304  
Con aislamiento del piso 70



Combined blast chiller  
With remote group and installation kit up to 10 meters  
**Capacity Trolley (not included) GN2/1 ou 600x1000mm**  
Defrosting through hot gas and forced ventilation  
AISI 304 stainless steel equipment  
With floor insulation 70

**2187.254 / 2187.256**

Grupo compressor à distância máxima de 10 metros.

**2187.264**  
Sem grupo

**2187.254 / 2187.256**

Groupe de compresseurs avec une distance maximale de 10 mètres

**2187.264**  
Sans groupe

**2187.254 / 2187.256**

Grupo compresor a distancia máxima de 10 metros

**2187.264**  
Sin grupo

**2187.254 / 2187.256**

Compressor group with a maximum distance of 10 meters.

**2187.264**  
Without group

Cód.	Ref.	P/ Modelo	€
2187.262	Condensador Água Condenseur à eau Condensador Agua Condenser Water	T40	1.987,00
2187.268	Kit Adicional de Instalação (metro) Kit d'installation supplémentaire (mètre) Kit adicional de instalación (metro) Additional Installation Kit (meter)	T40-150/200	129,00
2187.270	Porta adicional (Túnel) Porte supplémentaire (Tunnel) Puerta adicional (Túnel) Additional Door (Tunnel)	T40-150/200	4.291,00
2187.314	Carro Inox p/ 18 tab./plateaux/tray Charriot Acier Inox p/ 18 tab./plateaux/tray Carro Acero Inox p/ 18 tab./plateaux/tray Trolley Stainless Steel p/ 18 tab./plateaux/tray	GN 2/1	CONSULTAR
	Carro Inox p/ tab./plateaux/tray Charriot Acier Inox p/ tab./plateaux/tray Carro Acero Inox p/ tab./plateaux/tray Trolley Stainless Steel p/ tab./plateaux/tray	600x1000mm	 <b>sob pedido</b> sur demande a pedido on request



MODELO / MODÈLE / MODELO / MODEL		UDIT40-150- AÇO INOX	UDIT40-200- AÇO INOX	UDIT40/150-200 S/ GRUPO- AÇO INOX
CÓDIGO / CODE / CÓDIGO / CODE		2187.254	2187.256	2187.264
<b>Preço / Prix / Precio / Price</b>	€	<b>51.364,00</b>	<b>57.360,00</b>	<b>28.767,00</b>
Dimensões / Dimensions / Dimensiones	mm	1580x1390x2350	1580x1390x2350	1580x1390x2350
Dimensões Carro / Dimensions Charriot / Dimensiones Carro / Trolley Dimensions	mm	600X1000	600X1000	600X1000
Espessura Isolamento / Epaisseur d' isolation / Espesor de aislamiento / Isolation Thickness	mm	70	70	70
Descongelação / Décongélation / Descong. / Defrosting	M/A	A =Gás Quente/ Hot Gas	A =Gás Quente/ Hot Gas	A =Gás Quente/ Hot Gas
Gas refrigerante / Gaz réfrigérant / Gas refrigerante / Refrig. Gas		R 452a	R 452a	R 452a
Ciclo de abatimento / Cycle réfrigération / Ciclo refrigeración / Chilling cycle	(+90°/+3°C/ Kg)	150	200	150-200
Ciclo de congelação / Cycle congélation / Ciclo congelamiento / Freezing cycle	(+90°/-18°C/ Kg)	135	175	135-175
Peso Líquido-Bruto / Poids Net-Brut / Peso Neto-Bruto / Net-Gross Weight	kg	-/580	-/580	-/580
Potência / Puissance / Potência / Power	W	7400	9600	1400
Potência frigorífica / Puissance frigorifique / Potência frigorífica / Refrigerating Power	W	10970	14270	-
Tensão / Tension / Tensión / Tension	V	400	400	400

**2187.272 / 2187.274 / 2187.278 / 2187.280**  
Grupo compressor à distância máxima de 10 metros.  
**Capacidade 1 Carro (não incluído) GN1/1 ou GN2/1**  
Descongelação através de gás quente e ventilação forçada  
Equipamento em aço inox AISI 304

**2187.272 / 2187.274 / 2187.278 / 2187.280**  
Groupe de compresseurs avec une distance maximale de 10 mètres  
**Capacité 1 Charriot (non incluse) GN1/1 ou GN2/1**  
Dégivrage par gaz chaud et ventilation forcée  
Équipement en acier inoxydable AISI 304

**2187.272 / 2187.274 / 2187.278 / 2187.280**  
Grupo compressor a distancia máxima de 10 metros  
**Capacidad 1 Carro (no incluido) GN1/1 ou GN2/1**  
Descongelación a través de gas caliente y ventilación forzada  
Equipamiento en acero inoxidable AISI 304

**2187.272 / 2187.274 / 2187.278 / 2187.280**  
Compressor group with a maximum distance of 10 meters.  
**Capacity Trolley (not included) GN1/1 ou GN2/1**  
Defrosting through hot gas and forced ventilation  
AISI 304 stainless steel equipment

**2187.272 / 2187.274 / 2187.278 / 2187.280**  
Grupo compressor à distância máxima de 10 metros.

**2187.272 / 2187.274 / 2187.278 / 2187.280**  
Groupe de compresseurs avec une distance maximale de 10 mètres

**2187.272 / 2187.274 / 2187.278 / 2187.280**  
Grupo compressor a distancia máxima de 10 metros

**2187.272 / 2187.274 / 2187.278 / 2187.280**  
Compressor group with a maximum distance of 10 meters.

**2187.276 / 2187.282**  
Sem grupo

**2187.276 / 2187.282**  
Sans groupe

**2187.276 / 2187.282**  
Sin grupo

**2187.276 / 2187.282**  
Without group

Cód.	Ref.	P/ Modelo	€
2187.310	Carro Inox p/ 18 tab./plateaux/tray Charriot Acier Inox p/ 18 tab./plateaux/tray Carro Acero Inox p/ 18 tab./plateaux/tray Trolley Stainless Steel p/ 18 tab./plateaux/tray	GN 1/1	CONSULTAR
2187.314	Carro Inox p/ 18 tab./plateaux/tray Charriot Acier Inox p/ 18 tab./plateaux/tray Carro Acero Inox p/ 18 tab./plateaux/tray Trolley Stainless Steel p/ 18 tab./plateaux/tray	GN 2/1	CONSULTAR



Carros compatíveis com Fornos Rational 202\*\* e Convothem\*  
Charriots compatibles avec fours Rational 202\*\* et Convothem\*  
Carros compatibles con hornos Rational 202\*\* y Convothem\*  
Trolleys compatible with Rational 202\*\* and Convothem\* Ovens

MODELO / MODÈLE / MODELO / MODEL		UDIT40-C +/150- AÇO INOX	UDIT40-C +/200- AÇO INOX	UDIT40-C +150- 200 S/ GRUPO AÇO INOX	UDIT40-R /150 AÇO INOX	UDIT40-R /200 AÇO INOX	UDIT40-R /150- 200 S/ GRUPO AÇO INOX
CÓDIGO / CODE / CÓDIGO / CODE		2187.272	2187.274	2187.276	2187.278	2187.280	2187.282
<b>Preço / Prix / Precio / Price</b>	<b>€</b>	<b>53.503,00</b>	<b>59.868,00</b>	<b>31.899,00</b>	<b>53.503,00</b>	<b>59.868,00</b>	<b>31.899,00</b>
Dimensões / Dimensions / Dimensiones	mm	1580x1390x 2585	1580x1390x 2585	1580x1390x 2585	1580x1390x 2585	1580x1390x 2585	1580x1390x 2585
Dimensões Carro / Dimensions Charriot / Dimensiones Carro / Trolley Dimensions	mm	*	*	*	**	**	**
Espessura Isolamento / Epaisseur d'isolation / Espesor de aislamiento / Isolation Thickness	mm	70	70	70	70	70	70
Descongelação / Décongélation / Descong. / Defrosting	M/A	A =Gás Quente/ Hot Gas	A =Gás Quente/ Hot Gas	A =Gás Quente/ Hot Gas	A =Gás Quente/ Hot Gas	A =Gás Quente/ Hot Gas	A =Gás Quente/ Hot Gas
Gas refrigerante / Gaz réfrigérant / Gas refrigerante / Refrig. Gas		R 452a	R 452a	R 452a	R 452a	R 452a	R 452a
Ciclo de abatimento / Cycle réfrigération / Ciclo refrigeración / Chilling cycle	(+90°/+3°C/ Kg)	150	200	150-200	150	200	150-200
Ciclo de congelação / Cycle congélation / Ciclo congelamiento / Freezing cycle	(+90°/-18°C/ Kg)	135	175	135-175	135	175	135-175
Peso Líquido-Bruto / Poids Net-Brut / Peso Neto-Bruto / Net-Gross Weight	kg	-/310	-/320	-/580	-/310	-/320	-/580
Potência / Puissance / Potência / Power	W	7400	9600	7400	7400	9600	7400
Potência frigorífica / Puissance frigorifique / Potência frigorífica / Refrigerating Power	W	9380	14400	-	9380	14400	-
Tensão / Tension / Tensión / Tension	V	400	400	400	400	400	400



UDIfri

**ABATEDORES - CARRELADOS**  
CELLULES DE REFRROIDISSEMENT - CHARRIOT  
ABATIDORES - CARRO  
BLAST CHILLERS - TROLLEY



Abatedores de temperatura carrelados mistos  
Com grupo à distância e kit de instalação até 10 metros  
**Capacidade 2 carros Carros (não incluídos) GN2/1 ou 2x(600x800mm)**  
Descongelação através de gás quente e ventilação forçada  
Equipamento em aço inox AISI 304

**2187.286 / 2187.288**  
Grupo compressor à distância máxima de 10 metros.

**2187.294**  
Sem grupo



Cellules Refroidissements combiné mixte  
Avec groupe à distance et kit d'installation jusqu'à 10 mètres  
**Capacité 2 charriots Charriots (non incluses) GN2/1 ou 2x (600x800mm)**  
Dégivrage par gaz chaud et ventilation forcée  
Équipement en acier inoxydable AISI 304

**2187.286 / 2187.288**  
Groupe de compresseurs avec une distance maximale de 10 mètres

**2187.294**  
Sans groupe



Abatidores de temperatura cargados mistos  
Con grupo a distancia y kit de instalación hasta 10 metros  
**Capacidad 2 carros Carros (no incluidos) GN2/1 o 2x(600x800mm)**  
Descongelación a través de gas caliente y ventilación forzada  
Equipamiento en acero inoxidable AISI 304

**2187.286 / 2187.288**  
Grupo compresor a distancia máxima de 10 metros

**2187.294**  
Sin grupo



Combined blast chiller  
With remote group and installation kit up to 10 meters  
**Capacity 2 trolleys Trolleys (not included) GN2/1 or 2x(600x800mm)**  
Defrosting through hot gas and forced ventilation  
AISI 304 stainless steel equipment

**2187.286 / 2187.288**  
Compressor group with a maximum distance of 10 meters.

**2187.294**  
Without group

Cód.	Ref.	P/ Modelo	€
2187.290	Porta adicional (tunnel) Porte supplémentaire (tunnel) Puerta adicional (tunnel) Additional door (tunnel)	T50/270-400	4.381,00
2187.292	Condensador a Água Condenseur à eau Condensador de Água Water Condenser	T50	2.369,00
2187.296	Kit adicional de instalação (metro) Kit d'installation supplémentaire (compteur) Kit adicional de instalación (metro) Additional installation kit (meter)	P/ T50/270-200	173,00
2187.306	Carro Inox p/ 20 tab./plateaux/tray Charriot Acier Inox p/ 20 tab./plateaux/tray Carro Acero Inox p/ 20 tab./plateaux/tray Trolley Stainless Steel p/ 20 tab./plateaux/tray	600X800mm	CONSULTAR
2187.314	Carro Inox p/ 18 tab./plateaux/tray Charriot Acier Inox p/ 18 tab./plateaux/tray Carro Acero Inox p/ 18 tab./plateaux/tray Trolley Stainless Steel p/ 18 tab./plateaux/tray	GN 2/1	CONSULTAR



MODELO / MODÈLE / MODELO / MODEL		UDIT50/270- AÇO INOX	UDIT50/400- AÇO INOX	UDIT50/270-400 S/ GRUPO- AÇO INOX
CÓDIGO / CODE / CÓDIGO / CODE		2187.286	2187.288	2187.294
<b>Preço / Prix / Precio / Price</b>	<b>€</b>	<b>71.745,00</b>	<b>75.361,00</b>	<b>41.383,00</b>
Dimensões / Dimensions / Dimensiones	mm	1780x1790x2410	1780x1790x2410	1780x1790x2410
Dimensões Carro / Dimensions Charriot / Dimensiones Carro / Trolley Dimensions	mm	2XGN2/1(600X800)	2XGN2/1(600X800)	2XGN2/1(600X800)
Espessura Isolamento / Epaisseur d' isolation / Espesor de aislamiento / Isolation Thickness	mm	100	100	100
Descongelação / Décongélation / Descong. / Defrosting	M/A	A =Gás Quente/Hot Gas	A =Gás Quente/Hot Gas	A =Gás Quente/Hot Gas
Gas refrigerante / Gaz réfrigérant / Gas refrigerante / Refrig. Gas		R 452a	R 452a	R 452a
Ciclo de abatimento / Cycle réfrigération / Ciclo refrigeración / Chilling cycle	(+90°/+3°C/Kg)	270	390	390
Ciclo de congelação / Cycle congélation / Ciclo congelamiento / Freezing cycle	(+90°/-18°C/Kg)	250	365	365
Peso Líquido-Bruto / Poids Net-Brut / Peso Neto-Bruto / Net-Gross Weight	kg	-/580	-/690	-/690
Potência / Puissance / Potência / Power	W	13350	18000	3700
Potência frigorífica / Puissance frigorifique / Potência frigorífica / Refrigerating Power	W	18880	27630	-
Tensão / Tension / Tensión / Tension	V	400	400	400







udi fri

**VITRINES REFRIGERADAS VERTICAIS**  
VITRINES VERTICALES RÉFRIGÉRÉES  
VITRINAS REFRIGERADAS VERTICALES  
VERTICAL REFRIGERATED SHOWCASE



Vitrine expositora com grelhas ajustáveis;  
Com luz interna LED;  
Com fechadura (UDVEGF79);  
Cor branca;



Vitrine exposant avec persiennes réglables;  
LED lumière intérieure;  
Verrouillable (UDVEGF79);  
Blanc;



Expositor vitrina con lamas ajustables;  
Luz interior LED;  
Con llave (UDVEGF79);  
Blanco;



Exhibitor showcase with adjustable shelves;  
With built-in LED light;  
With lock (UDVEGF79);  
White color;

Fechadura  
Serrure  
Con llave  
With lock



MODELO / MODÈLE / MODELO / MODEL	UDVEGF79	
CÓDIGO / CODE / CÓDIGO / CODE	2829.690	
<b>Preço / Prix / Precio / Price</b>	€	<b>806,00</b>
Dimensões / Dimensions / Dimensiones	mm	425x380x960
Volume / Volume / Volume / Volume	lt	78
Temperatura Refrigeração / Temp. Refroidissement / Temp. Enfriamiento / Cooling Temp.	°C	0/+12
Grelhas / Étagères / Estantes / Shelves	nr	3
Peso / Poids / Peso / Weight	kg	36
Consumo / Consommation / Consumo / Consumption	kW (24h)	2
Potência / Puissance / Potencia / Power	W	180
Tensão / Tension / Tension / Tension	V	230



MODELO / MODÈLE / MODELO / MODEL	UDVEGA80	
CÓDIGO / CODE / CÓDIGO / CODE	2829.691	
<b>Preço / Prix / Precio / Price</b>	€	<b>822,00</b>
Dimensões / Dimensions / Dimensiones	mm	428x386x960
Volume / Volume / Volume / Volume	lt	78
Temperatura Refrigeração / Temp. Refroidissement / Temp. Enfriamiento / Cooling Temp.	°C	0/+12
Grelhas / Étagères / Estantes / Shelves	nr	3
Peso / Poids / Peso / Weight	kg	36
Consumo / Consommation / Consumo / Consumption	kW (24h)	2
Potência / Puissance / Potencia / Power	W	180
Tensão / Tension / Tension / Tension	V	230

Panel de Controlo Frontal / Panneau de contrôle frontal/ Panel de control frontal / Front Control Panel



MODELO / MODÈLE / MODELO / MODEL	UDVEGF236	
CÓDIGO / CODE / CÓDIGO / CODE	2829.692	
<b>Preço / Prix / Precio / Price</b>	€	<b>1.959,00</b>
Dimensões / Dimensions / Dimensiones	mm	515x485x1690
Volume / Volume / Volume / Volume	lt	235
Temperatura Refrigeração / Temp. Refroidissement / Temp. Enfriamiento / Cooling Temp.	°C	0/+12
Grelhas / Étagères / Estantes / Shelves	nr	4
Peso / Poids / Peso / Weight	kg	76
Consumo / Consommation / Consumo / Consumption	kW (24h)	5,5
Potência / Puissance / Potencia / Power	W	250
Tensão / Tension / Tension / Tension	V	230



Panel de Controlo Frontal / Panneau de contrôle frontal/ Panel de control frontal / Front Control Panel

MODELO / MODÈLE / MODELO / MODEL	UDVEGF286	
CÓDIGO / CODE / CÓDIGO / CODE	2829.694	
<b>Preço / Prix / Precio / Price</b>	€	<b>2.146,00</b>
Dimensões / Dimensions / Dimensiones	mm	515x485x1895
Volume / Volume / Volume / Volume	lt	285
Temperatura Refrigeração / Temp. Refroidissement / Temp. Enfriamiento / Cooling Temp.	°C	0/+12
Grelhas / Étagères / Estantes / Shelves	nr	5
Peso / Poids / Peso / Weight	kg	88
Consumo / Consommation / Consumo / Consumption	kW (24h)	6
Potência / Puissance / Potencia / Power	W	300
Tensão / Tension / Tension / Tension	V	230

# VITRINAS EXPOSITORAS

MAIS  
INFORMAÇÃO  
MORE INFO



## LUXOR NEW STYLE DÁ VIDA AO SEU ESPAÇO

Graças ao sensor de proximidade PIR Sense: a vitrine muda a intensidade da luz à medida que o público se aproxima. É uma forma de convidar as pessoas a apreciar, chamar a atenção, cuidar do cliente e aprimorar o conteúdo.

### DISPLAY CABINETS

LUXOR NEW STYLE GIVES LIFE TO YOUR VENUE

Due to the PIR Sense proximity sensor, the window changes the light intensity as the public approaches. It's a way to draw attention, to invite people to appreciate the display, to take care of the customer and enhance the product.

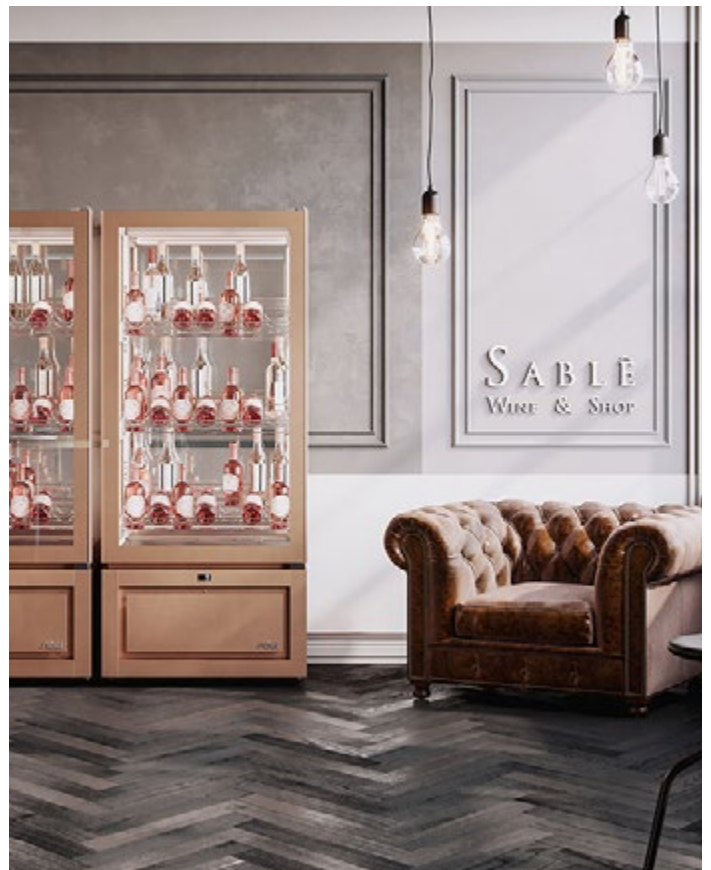

## LINHAS DE VITRINAS EXCLUSIVAS

EXCLUSIVE DISPLAY CABINETS

# VITRINAS EXPOSITORAS



NOVO  
NOUVEAU  
NUEVO  
NEW

MODELO / MODÈLE / MODELO / MODEL CÓDIGO / CODE / CÓDIGO / CODE		KP6G 2186.350	KP8G 2186.374
<b>Preço / Prix / Precio / Price</b>	€	<b>5.626,00</b>	<b>6.113,00</b>
Dimensões / Dimensions / Dimensiones	mm	600x645x1840	805x645x1840
Temperatura Refrigeração / Temp. Refroidissement / Temp. Enfriamiento / Cooling Temp.	°C	+2/+10	+2/+10
Humidade Relativa / Humidité / Humedad / Relative Humidity	%	70	70
Gás refrig. / Gaz réfrig. / Gas refrig. / Refrig. gas		R290	R290
Descongelação / Décongélation / Descong. / Defrosting	A/M** (AR/GQ)	A (AR)	A (AR)
Refrigeração / Refrigeration / Refrigeracion / Cooling	S/V*	V	V
Dimensão prateleira / Dimensions grilles / Dimensiones rejillas / Grids dimensions	mm	490x470	700x470
Prateleiras / Étagères / Estantes / Shelves	nr	5	5
Peso Líquido-Bruto / Poids Net-Brut / Peso Neto-Bruto / Net-Gross Weight	kg	171-191	211-236
Potência Elétrica / Puissance Électrique / Potencia Eléctrica / Electric Power	W	360	520
Potência Grupo Frigorífico / Puissance Groupe Frig. / Fridge Group Power	W	632	851
Tensão / Tension / Tension / Tension	V	230	230

 NOVO  
NOUVEAU  
NUEVO  
NEW

MODELO / MODÈLE / MODELO / MODEL CÓDIGO / CODE / CÓDIGO / CODE		KD6G 2186.354	KD8G 2186.378
<b>Preço / Prix / Precio / Price</b>	€	<b>7.957,00</b>	<b>8.645,00</b>
Dimensões / Dimensions / Dimensiones	mm	600x645x 1840	805x645x 1840
Temperatura Refrigeração / Temp. Refroidissement / Temp. Enfriamiento / Cooling Temp.	°C	-22/+5	-22/+5
Humidade Relativa / Humidité / Humedad / Relative Humidity	%	65 / 40	65 / 40
Gás refrig. / Gaz réfrig. / Gas refrig. / Refrig. gas		R290	R290
Descongelação / Décongélation / Descong. / Defrosting	A/M** (AR/GQ)	A (GQ)	A (GQ)
Refrigeração / Refrigeration / Refrigeracion / Cooling	S/V*	V	V
Dimensão prateleira / Dimensions grilles / Dimensiones rejillas / Grids dimensions	mm	490x470	700x470
Prateleiras / Étagères / Estantes / Shelves	nr	5	5
Peso Líquido-Bruto / Poids Net-Brut / Peso Neto-Bruto / Net-Gross Weight	kg	217/236	232/256
Potência Elétrica / Puissance Électrique / Potencia Eléctrica / Electric Power	W	1250	1700
Potência Grupo Frigorífico / Puissance Groupe Frig. / Fridge Group Power	W	931	1052
Tensão / Tension / Tension / Tension	V	230	230

Chocolate

 NOVO  
NOUVEAU  
NUEVO  
NEW

MODELO / MODÈLE / MODELO / MODEL CÓDIGO / CODE / CÓDIGO / CODE		KC6G 2186.356	KC8G 2186.380
<b>Preço / Prix / Precio / Price</b>	€	<b>6.538,00</b>	<b>7.208,00</b>
Dimensões / Dimensions / Dimensiones	mm	600x645x 1840	805x645x1840
Temperatura Refrigeração / Temp. Refroidissement / Temp. Enfriamiento / Cooling Temp.	°C	+14/+16	+14/+16
Humidade Relativa / Humidité / Humedad / Relative Humidity	%	40/44	40/44
Gás refrig. / Gaz réfrig. / Gas refrig. / Refrig. gas		R290	R290
Descongelação / Décongélation / Descong. / Defrosting	A/M** (AR/GQ)	A (AR)	A (AR)
Refrigeração / Refrigeration / Refrigeracion / Cooling	S/V*	V	V
Dimensão prateleira / Dimensions grilles / Dimensiones rejillas / Grids dimensions	mm	490x470	700x470
Prateleiras / Étagères / Estantes / Shelves	nr	5	5
Peso Líquido-Bruto / Poids Net-Brut / Peso Neto-Bruto / Net-Gross Weight	kg	171-191	211-236
Potência Elétrica / Puissance Électrique / Potencia Eléctrica / Electric Power	W	270	300
Potência Grupo Frigorífico / Puissance Groupe Frig. / Fridge Group Power	W	362	425
Tensão / Tension / Tension / Tension	V	230	230

 Conservação de  
Congelados

 NOVO  
NOUVEAU  
NUEVO  
NEW

MODELO / MODÈLE / MODELO / MODEL CÓDIGO / CODE / CÓDIGO / CODE		KG6G 2186.352	KG8G 2186.376
<b>Preço / Prix / Precio / Price</b>	€	<b>7.104,00</b>	<b>7.719,00</b>
Dimensões / Dimensions / Dimensiones	mm	600x645x 1840	805x645x1840
Temperatura Refrigeração / Temp. Refroidissement / Temp. Enfriamiento / Cooling Temp.	°C	-25/-15	-25/-15
Humidade Relativa / Humidité / Humedad / Relative Humidity	%	75	75
Gás refrig. / Gaz réfrig. / Gas refrig. / Refrig. gas		R290	R290
Descongelação / Décongélation / Descong. / Defrosting	A/M** (AR/GQ)	M	M
Refrigeração / Refrigeration / Refrigeracion / Cooling	S/V*	S	S
Dimensão prateleira / Dimensions grilles / Dimensiones rejillas / Grids dimensions	mm	450x460	650x460/ 650x420
Prateleiras / Étagères / Estantes / Shelves	nr	5	5 / 1
Peso Líquido-Bruto / Poids Net-Brut / Peso Neto-Bruto / Net-Gross Weight	kg	197-222	217-242
Potência Elétrica / Puissance Électrique / Potencia Eléctrica / Electric Power	W	850	900
Potência Grupo Frigorífico / Puissance Groupe Frig. / Fridge Group Power	W	931	1052
Tensão / Tension / Tension / Tension	V	230	230

\*V = Ventilada / Ventilé / Ventilada / Ventilated | S = Estática / Static / Estática / Static

\*\*A - Automático / Automatique / Automatic / Automatic - M - Manual / Manuel / Manual / Manual | (AR - Ar / Aire / Aire / Air | GQ - Gás Quente / Gaz Chaud / Gas Caliente / Hot Gas)

 Modelos KP, KC, KD, peso máximo por prateleira = 12Kg  
 Les modèles KP, KC, KD, le poids maximum par tablette = 12 kg  
 Los modelos KP, KC, KD, peso máximo = por estante 12 kg  
 Models KP, KC, KD, maximum weight per shelf = 12Kg

**SQGI****LUXOR WHITE  
600/800****VITRINES REFRIGERADAS VERTICAIS**  
VITRINES VERTICALES RÉFRIGÉRÉES  
VITRINAS REFRIGERADAS VERTICALES  
VERTICAL REFRIGERATED SHOWCASE**NOVO  
NOUVEAU  
NUEVO  
NEW**

MODELO / MODÈLE / MODELO / MODEL CÓDIGO / CODE / CÓDIGO / CODE		KP6V 2186.358	KP8V 2186.390
<b>Preço / Prix / Precio / Price</b>	€	<b>6860,00</b>	<b>7.617,00</b>
Dimensões / Dimensions / Dimensiones	mm	600x645x 1840	805x645x 1840
Temperatura Refrigeração / Temp. Refroidissement / Temp. Enfriamiento / Cooling Temp.	°C	+2/+10	+2/+10
Humidade Relativa / Humidité / Humedad / Relative Humidity	%	70	70
Gás refrigerante / Gaz réfrigérant / Gas refrigerante / Refrig. gas		R290	R290
Descongelação / Décongélation / Descong. / Defrosting	A/M** (AR/GQ)	A (AR)	A (AR)
Refrigeração / Refrigeration / Refrigeracion / Cooling	S/V*	V	V
Dimensão prateleira / Dimensions grilles / Dimensiones rejillas / Grids dimensions	mm	490x470	700x470
Grelhas / Étagères / Estantes / Shelves	nr	5	5
Peso Líquido-Bruto / Poids Net-Brut / Peso Neto-Bruto / Net-Gross Weight	kg	178-198	222/247
Potência Elétrica / Puissance Électrique / Potencia Eléctrica / Electric Power	W	400	550
Potência Grupo Frigorífico / Puissance Groupe Frig. / Fridge Group Power	W	632	851
Tensão / Tension / Tension / Tension	V	230	230

**NOVO  
NOUVEAU  
NUEVO  
NEW**

MODELO / MODÈLE / MODELO / MODEL CÓDIGO / CODE / CÓDIGO / CODE		KD6V 2186.364	KD8V 2186.394
<b>Preço / Prix / Precio / Price</b>	€	<b>8.993,00</b>	<b>9.897,00</b>
Dimensões / Dimensions / Dimensiones	mm	600x645x 1840	805x645x 1840
Temperatura Refrigeração / Temp. Refroidissement / Temp. Enfriamiento / Cooling Temp.	°C	-22/+5	(-22/+5)
Humidade Relativa / Humidité / Humedad / Relative Humidity	%	65 / 40	65/40
Gás refrigerante / Gaz réfrigérant / Gas refrigerante / Refrig. gas		R290	R290
Descongelação / Décongélation / Descong. / Defrosting	A/M** (AR/GQ)	A (GQ)	A (GQ)
Refrigeração / Refrigeration / Refrigeracion / Cooling	S/V*	V	V
Dimensão prateleira / Dimensions grilles / Dimensiones rejillas / Grids dimensions	mm	490x470	700x470
Grelhas / Étagères / Estantes / Shelves	nr	5	5
Peso Líquido-Bruto / Poids Net-Brut / Peso Neto-Bruto / Net-Gross Weight	kg	224-244	243/267
Potência Elétrica / Puissance Électrique / Potencia Eléctrica / Electric Power	W	1300	1750
Potência Grupo Frigorífico / Puissance Groupe Frig. / Fridge Group Power	W	931	1052
Tensão / Tension / Tension / Tension	V	230	230

**Chocolate****NOVO  
NOUVEAU  
NUEVO  
NEW**

MODELO / MODÈLE / MODELO / MODEL CÓDIGO / CODE / CÓDIGO / CODE		KC6V 2186.360	KC8V 2186.396
<b>Preço / Prix / Precio / Price</b>	€	<b>7.800,00</b>	<b>8.663,00</b>
Dimensões / Dimensions / Dimensiones	mm	600x645x 1840	805x645x1840
Temperatura Refrigeração / Temp. Refroidissement / Temp. Enfriamiento / Cooling Temp.	°C	+14/+16	+14/+16
Humidade Relativa / Humidité / Humedad / Relative Humidity	%	40/44	40/44
Gás refrigerante / Gaz réfrigérant / Gas refrigerante / Refrig. gas		R290	R290
Descongelação / Décongélation / Descong. / Defrosting	A/M** (AR/GQ)	A (AR)	A (AR)
Refrigeração / Refrigeration / Refrigeracion / Cooling	S/V*	V	V
Dimensão prateleira / Dimensions grilles / Dimensiones rejillas / Grids dimensions	mm	490x470	700x470
Grelhas / Étagères / Estantes / Shelves	nr	5	5
Peso Líquido-Bruto / Poids Net-Brut / Peso Neto-Bruto / Net-Gross Weight	kg	178-188	222/247
Potência Elétrica / Puissance Électrique / Potencia Eléctrica / Electric Power	W	330	360
Potência Grupo Frigorífico / Puissance Groupe Frig. / Fridge Group Power	W	362	425
Tensão / Tension / Tension / Tension	V	230	230

**Conservação de  
Congelados****NOVO  
NOUVEAU  
NUEVO  
NEW**

MODELO / MODÈLE / MODELO / MODEL CÓDIGO / CODE / CÓDIGO / CODE		KG6V 2186.362	KG8V 2186.392
<b>Preço / Prix / Precio / Price</b>	€	<b>8.244,00</b>	<b>9.157,00</b>
Dimensões / Dimensions / Dimensiones	mm	600x645x 1840	805x645x1840
Temperatura Refrigeração / Temp. Refroidissement / Temp. Enfriamiento / Cooling Temp.	°C	-25/-15	-25/-15
Humidade Relativa / Humidité / Humedad / Relative Humidity	%	75	75
Gás refrigerante / Gaz réfrigérant / Gas refrigerante / Refrig. gas		R290	R404A
Descongelação / Décongélation / Descong. / Defrosting	A/M** (AR/GQ)	M	M
Refrigeração / Refrigeration / Refrigeracion / Cooling	S/V*	S	S
Dimensão prateleira / Dimensions grilles / Dimensiones rejillas / Grids dimensions	mm	450x460	650x460/ 650x420
Grelhas / Étagères / Estantes / Shelves	nr	5	5 / 1
Peso Líquido-Bruto / Poids Net-Brut / Peso Neto-Bruto / Net-Gross Weight	kg	191-222	228/253
Potência Elétrica / Puissance Électrique / Potencia Eléctrica / Electric Power	W	850	1000
Potência Grupo Frigorífico / Puissance Groupe Frig. / Fridge Group Power	W	931	1140
Tensão / Tension / Tension / Tension	V	230	230

\*V = Ventilada / Ventilé / Ventilada / Ventilated | S = Estática / Static / Estática / Static  
 \*\*A - Automático / Automatique / Automatic / Automatic - M - Manual / Manuel / Manual / Manual | (AR - Ar / Aire / Aire / Air | GQ - Gás Quente / Gaz Chaud / Gas Caliente / Hot Gas)

Modelos KP, KC, KD, peso máximo por prateleira = 12Kg  
 Les modèles KP, KC, KD, le poids maximum par tablette = 12 kg  
 Los modelos KP, KC, KD, peso máximo = por estante 12 kg  
 Models KP, KC, KD, maximum weight per shelf = 12Kg

**SUPORTE EXPOSIÇÃO GARRAFAS**

opcional  
opcional  
opcional

Modelos 8 KP, KC  
 Modèles 8 KP, KC  
 Modelos 8 KP, KC  
 Modelos 8 KP, KC



**2186.398**  
**9.157,00**

NOVO  
 NOUVEAU  
 NUEVO  
 NEW

MODELO / MODÈLE / MODELO / MODEL CÓDIGO / CODE / CÓDIGO / CODE	SABLÈ KP8E 2186.422	
<b>Preço / Prix / Precio / Price</b>	€	<b>7.617,00</b>
Dimensões / Dimensions / Dimensiones	mm	805x645x1840
Temperatura / Température / Temperatura / Temperature	°C	+2/+10
Humidade Relativa / Humidité / Humedad / Relative Humidity	%	70
Gás refrig. / Gaz réfrig. / Gas refrig. / Refrig, gas		R290
Descongelação / Décongélation / Descong. / Defrosting	A/M** (AR/GQ)	A(AR)
Refrigeração / Refrigeration / Refrigeracion / Cooling	S/V*	V
Dimensão prateleira / Dimensions grilles / Dimensiones rejillas / Grids dimensions	mm	700x470
Prateleiras / Étagères / Estantes / Shelves	nr	5
Peso Líquido-Bruto / Poids Net-Brut / Peso Neto-Bruto / Net-Gross Weight	kg	222-247
Potência / Puissance / Potencia / Power	W	550
Potência Grupo Frigorífico / Puissance Groupe Frig. / Fridge Group Power	W	851
Tensão / Tension / Tension / Tension	V	230

 NOVO  
 NOUVEAU  
 NUEVO  
 NEW

MODELO / MODÈLE / MODELO / MODEL CÓDIGO / CODE / CÓDIGO / CODE	SABLÈ KD8E 2186.426	
<b>Preço / Prix / Precio / Price</b>	€	<b>9.897,00</b>
Dimensões / Dimensions / Dimensiones	mm	805x645x1840
Temperatura / Température / Temperatura / Temperature	°C	-22/+5
Humidade Relativa / Humidité / Humedad / Relative Humidity	%	65/40
Gás refrig. / Gaz réfrig. / Gas refrig. / Refrig, gas		R290
Descongelação / Décongélation / Descong. / Defrosting	A/M** (AR/GQ)	A(GQ)
Refrigeração / Refrigeration / Refrigeracion / Cooling	S/V*	V
Dimensão prateleira / Dimensions grilles / Dimensiones rejillas / Grids dimensions	mm	700x470
Prateleiras / Étagères / Estantes / Shelves	nr	5
Peso Líquido-Bruto / Poids Net-Brut / Peso Neto-Bruto / Net-Gross Weight	kg	243-267
Potência / Puissance / Potencia / Power	W	1750
Potência Grupo Frigorífico / Puissance Groupe Frig. / Fridge Group Power	W	1052
Tensão / Tension / Tension / Tension	V	230

Chocolate

 NOVO  
 NOUVEAU  
 NUEVO  
 NEW

MODELO / MODÈLE / MODELO / MODEL CÓDIGO / CODE / CÓDIGO / CODE	SABLÈ KC8E 2186.428	
<b>Preço / Prix / Precio / Price</b>	€	<b>8.663,00</b>
Dimensões / Dimensions / Dimensiones	mm	805x645x1840
Temperatura / Température / Temperatura / Temperature	°C	+14/+16
Humidade Relativa / Humidité / Humedad / Relative Humidity	%	40/44
Gás refrig. / Gaz réfrig. / Gas refrig. / Refrig, gas		R290
Descongelação / Décongélation / Descong. / Defrosting	A/M** (AR/GQ)	A(AR)
Refrigeração / Refrigeration / Refrigeracion / Cooling	S/V*	V
Dimensão prateleira / Dimensions grilles / Dimensiones rejillas / Grids dimensions	mm	700x470
Prateleiras / Étagères / Estantes / Shelves	nr	5
Peso Líquido-Bruto / Poids Net-Brut / Peso Neto-Bruto / Net-Gross Weight	kg	222-247
Potência / Puissance / Potencia / Power	W	360
Potência Grupo Frigorífico / Puissance Groupe Frig. / Fridge Group Power	W	425
Tensão / Tension / Tension / Tension	V	230

 Conservação de  
 Congelados

 NOVO  
 NOUVEAU  
 NUEVO  
 NEW

MODELO / MODÈLE / MODELO / MODEL CÓDIGO / CODE / CÓDIGO / CODE	SABLÈ KG8E 2186.424	
<b>Preço / Prix / Precio / Price</b>	€	<b>9.157,00</b>
Dimensões / Dimensions / Dimensiones	mm	805x645x1840
Temperatura / Température / Temperatura / Temperature	°C	-25/-15
Humidade Relativa / Humidité / Humedad / Relative Humidity	%	75
Gás refrig. / Gaz réfrig. / Gas refrig. / Refrig, gas		R290
Descongelação / Décongélation / Descong. / Defrosting	A/M** (AR/GQ)	M
Refrigeração / Refrigeration / Refrigeracion / Cooling	S/V*	S
Dimensão prateleira / Dimensions grilles / Dimensiones rejillas / Grids dimensions	mm	650x460/ 650x420
Prateleiras-grelhas / Étagères-Grills / Estantes-Rejillas / Shelves-Grids	nr	5 / 1
Peso Líquido-Bruto / Poids Net-Brut / Peso Neto-Bruto / Net-Gross Weight	kg	228-253
Potência / Puissance / Potencia / Power	W	930
Potência Grupo Frigorífico / Puissance Groupe Frig. / Fridge Group Power	W	1052
Tensão / Tension / Tension / Tension	V	230

\*V = Ventilada / Ventilé / Ventilada / Ventilated | S =  
 Estática / Static / Estática / Static  
 \*\*A - Automático / Automatique / Automatico / Auto-  
 matic - M - Manual / Manuel / Manual / Manual | (AR  
 - Ar / Aire / Aire / Air | GQ - Gás Quente / Gaz Chaud /  
 Gas Caliente / Hot Gas)

Modelos KP, KC, KD, peso máximo por prateleira = 12Kg  
 Los modelos KP, KC, KD, peso máximo = pr estante 12 kg  
 Les odèles KP, KC, KD, le poids maximum par tablette = 12 kg  
 Models KP, KC, KD, maximum weight per shelf = 12Kg

**SUPORTE EXPOSIÇÃO GARRAFAS**

 opcional  
 optionnel  
 optional

 Modelos 8 KP, KC  
 Modèles 8 KP, KC  
 Modelos 8 KP, KC  
 Modelos 8 KP, KC

**2186.398**  
**9.157,00**

**SAGI**

# LUXOR BLACK 600/800

**VITRINES REFRIGERADAS VERTICAIS**  
VITRINES VERTICALES RÉFRIGÉRÉES  
VITRINAS REFRIGERADAS VERTICALES  
VERTICAL REFRIGERATED SHOWCASE**NOVO  
NOUVEAU  
NUEVO  
NEW**

MODELO / MODÈLE / MODELO / MODEL CÓDIGO / CODE / CÓDIGO / CODE		KP6A 2186.366	KP8A 2186.382
<b>Preço / Prix / Precio / Price</b>	€	<b>6.860,00</b>	<b>7.617,00</b>
Dimensões / Dimensions / Dimensiones	mm	600x645x 1840	805x645x 1840
Temperatura / Température / Temperatura / Temperature	°C	+2/+10	+2/+10
Humidade Relativa / Humidité / Humedad / Relative Humidity	%	70	70
Gás refrigerante / Gaz réfrigérant / Gas refrigerante / Refrig. gas		R290	R290
Descongelação / Décongélation / Descong. / Defrosting	A/M** (AR/GQ)	A (AR)	A (AR)
Refrigeração / Refrigeration / Refrigeracion / Cooling	S/V*	V	V
Dimensão prateleira / Dimensions grilles / Dimensiones rejillas / Grids dimensions	mm	490x470	700x470
Grelhas / Étagères / Estantes / Shelves	nr	5	5
Peso Líquido-Bruto / Poids Net-Brut / Peso Neto-Bruto / Net-Gross Weight	kg	178/198	222/247
Potência / Puissance / Potencia / Power	W	400	550
Potência Grupo Frigorífico / Puissance Groupe Frig. / Fridge Group Power	W	632	851
Tensão / Tension / Tension / Tension	V	230	230

**NOVO  
NOUVEAU  
NUEVO  
NEW**

MODELO / MODÈLE / MODELO / MODEL CÓDIGO / CODE / CÓDIGO / CODE		KD6A 2186.372	KD8A 2186.386
<b>Preço / Prix / Precio / Price</b>	€	<b>8.993,00</b>	<b>9.897,00</b>
Dimensões / Dimensions / Dimensiones	mm	600x645x 1840	805x645x1840
Temperatura / Température / Temperatura / Temperature	°C	-22/+5	-22/+5
Humidade Relativa / Humidité / Humedad / Relative Humidity	%	65 / 40	65 / 40
Gás refrigerante / Gaz réfrigérant / Gas refrigerante / Refrig. gas		R290	R290
Descongelação / Décongélation / Descong. / Defrosting	A/M** (AR/GQ)	A (GQ)	A (GQ)
Refrigeração / Refrigeration / Refrigeracion / Cooling	S/V*	V	V
Dimensão prateleira / Dimensions grilles / Dimensiones rejillas / Grids dimensions	mm	490x470	700x470
Grelhas / Étagères / Estantes / Shelves	nr	5	5
Peso Líquido-Bruto / Poids Net-Brut / Peso Neto-Bruto / Net-Gross Weight	kg	224-244	243-267
Potência / Puissance / Potencia / Power	W	1300	1750
Potência Grupo Frigorífico / Puissance Groupe Frig. / Fridge Group Power	W	931	1052
Tensão / Tension / Tension / Tension	V	230	230

## Chocolate

**NOVO  
NOUVEAU  
NUEVO  
NEW**

MODELO / MODÈLE / MODELO / MODEL CÓDIGO / CODE / CÓDIGO / CODE		KC6A 2186.368	KC8A 2186.388
<b>Preço / Prix / Precio / Price</b>	€	<b>7.800,00</b>	<b>8.663,00</b>
Dimensões / Dimensions / Dimensiones	mm	600x645x 1840	805x645x1840
Temperatura / Température / Temperatura / Temperature	°C	+14/+16	+14/+16
Humidade Relativa / Humidité / Humedad / Relative Humidity	%	40/44	40/44
Gás refrigerante / Gaz réfrigérant / Gas refrigerante / Refrig. gas		R290	R290
Descongelação / Décongélation / Descong. / Defrosting	A/M** (AR/GQ)	A (AR)	A (AR)
Refrigeração / Refrigeration / Refrigeracion / Cooling	S/V*	V	V
Dimensão prateleira / Dimensions grilles / Dimensiones rejillas / Grids dimensions	mm	490x470	700x470
Grelhas / Étagères / Estantes / Shelves	nr	5	5
Peso Líquido-Bruto / Poids Net-Brut / Peso Neto-Bruto / Net-Gross Weight	kg	178-198	222/247
Potência / Puissance / Potencia / Power	W	330	360
Potência Grupo Frigorífico / Puissance Groupe Frig. / Fridge Group Power	W	362	425
Tensão / Tension / Tension / Tension	V	230	230

## Conservação de Congelados

**NOVO  
NOUVEAU  
NUEVO  
NEW**

MODELO / MODÈLE / MODELO / MODEL CÓDIGO / CODE / CÓDIGO / CODE		KG6A 2186.370	KG8A 2186.384
<b>Preço / Prix / Precio / Price</b>	€	<b>8.244,00</b>	<b>9.157,00</b>
Dimensões / Dimensions / Dimensiones	mm	600x645x 1840	805x645x1840
Temperatura / Température / Temperatura / Temperature	°C	-25/-15	-25/-15
Humidade Relativa / Humidité / Humedad / Relative Humidity	%	75	75
Gás refrigerante / Gaz réfrigérant / Gas refrigerante / Refrig. gas		R290	R290
Descongelação / Décongélation / Descong. / Defrosting	A/M** (AR/GQ)	M	M
Refrigeração / Refrigeration / Refrigeracion / Cooling	S/V*	S	S
Dimensão prateleira / Dimensions grilles / Dimensiones rejillas / Grids dimensions	mm	450x460	650x460/ 650x420
Grelhas / Étagères / Estantes / Shelves	nr	5	5 / 1
Peso Líquido-Bruto / Poids Net-Brut / Peso Neto-Bruto / Net-Gross Weight	kg	204-224	228/253
Potência / Puissance / Potencia / Power	W	880	930
Potência Grupo Frigorífico / Puissance Groupe Frig. / Fridge Group Power	W	931	1052
Tensão / Tension / Tension / Tension	V	230	230

\*V = Ventilada / Ventilé / Ventilada / Ventilated | S = Estática / Static / Estática / Static  
 \*\*A - Automático / Automatique / Automatico / Automatic - M - Manual / Manuel / Manual / Manual | (AR - Ar / Aire / Aire / Air | GQ - Gás Quente / Gaz Chaud / Gas Caliente / Hot Gas)

Modelos KP, KC, KD, peso máximo por prateleira = 12Kg  
 Los modelos KP, KC, KD, peso máximo = pr estante 12 kg  
 Les odèles KP, KC, KD, le poids maximum par tablette = 12 kg  
 Models KP, KC, KD, maximum weight per shelf = 12Kg

## SUPORTE EXPOSIÇÃO GARRAFAS



Modelos 8 KP, KC  
 Modèles 8 KP, KC  
 Modelos 8 KP, KC  
 Modelos 8 KP, KC



**2186.398**  
**9.157,00**



MODELO / MODÈLE / MODELO / MODEL CÓDIGO / CODE / CÓDIGO / CODE		KP8Q 2186.402
<b>Preço / Prix / Precio / Price</b>	<b>€</b>	<b>6.113,00</b>
Dimensões / Dimensions / Dimensiones	mm	805x645x1840
Temperatura Refrigeração / Temp. Refroidissement / Temp. Enfriamiento / Cooling Temp.	°C	+2/+10
Humidade Relativa / Humidité / Humedad / Relative Humidity	%	70
Gás refrig. / Gaz réfrig. / Gas refrig. / Refrig. gas		R404A
Descongelação / Décongélation / Descong. / Defrosting	A/M** (AR/GQ)	A (AR)
Refrigeração / Refrigeration / Refrigeracion / Cooling	S/V*	V
Dimensão prateleira / Dimensions grilles / Dimensiones rejillas / Grids dimensions	mm	700x470
Prateleiras / Étagères / Estantes / Shelves	nr	5
Peso Líquido-Bruto / Poids Net-Brut / Peso Neto-Bruto / Net-Gross Weight	kg	211-236
Potência Elétrica / Puissance Électrique / Potencia Eléctrica / Electric Power	W	520
Potência Grupo Frigorífico / Puissance Groupe Frig. / Fridge Group Power	W	851
Tensão / Tension / Tension / Tension	V	230



MODELO / MODÈLE / MODELO / MODEL CÓDIGO / CODE / CÓDIGO / CODE		KD6Q 2186.401B	KD8Q 2186.406
<b>Preço / Prix / Precio / Price</b>	<b>€</b>	<b>7.957,00</b>	<b>8.645,00</b>
Dimensões / Dimensions / Dimensiones	mm	600x645x 1840	805x645x1840
Temperatura Refrigeração / Temp. Refroidissement / Temp. Enfriamiento / Cooling Temp.	°C	-22/+5	-20/+5
Humidade Relativa / Humidité / Humedad / Relative Humidity	%	65 / 40	65 / 40
Gás refrig. / Gaz réfrig. / Gas refrig. / Refrig. gas		R404A	R404A
Descongelação / Décongélation / Descong. / Defrosting	A/M** (AR/GQ)	A (GQ)	A (GQ)
Refrigeração / Refrigeration / Refrigeracion / Cooling	S/V*	V	V
Dimensão prateleira / Dimensions grilles / Dimensiones rejillas / Grids dimensions	mm	490x470	700x470
Prateleiras / Étagères / Estantes / Shelves	nr	5	5
Peso Líquido-Bruto / Poids Net-Brut / Peso Neto-Bruto / Net-Gross Weight	kg	212/236	232/256
Potência Elétrica / Puissance Électrique / Potencia Eléctrica / Electric Power	W	1100	1200
Potência Grupo Frigorífico / Puissance Groupe Frig. / Fridge Group Power	W	869	1140
Tensão / Tension / Tension / Tension	V	230	230



MODELO / MODÈLE / MODELO / MODEL CÓDIGO / CODE / CÓDIGO / CODE		KG8Q 2186.404
<b>Preço / Prix / Precio / Price</b>	<b>€</b>	<b>7.719,00</b>
Dimensões / Dimensions / Dimensiones	mm	805x645x1840
Temperatura Refrigeração / Temp. Refroidissement / Temp. Enfriamiento / Cooling Temp.	°C	-25/-15
Humidade Relativa / Humidité / Humedad / Relative Humidity	%	75
Gás refrig. / Gaz réfrig. / Gas refrig. / Refrig. gas		R290
Descongelação / Décongélation / Descong. / Defrosting	A/M** (AR/GQ)	M
Refrigeração / Refrigeration / Refrigeracion / Cooling	S/V*	S
Dimensão prateleira / Dimensions grilles / Dimensiones rejillas / Grids dimensions	mm	650x460
Prateleiras / Étagères / Estantes / Shelves	nr	5
Peso Líquido-Bruto / Poids Net-Brut / Peso Neto-Bruto / Net-Gross Weight	kg	242
Potência Elétrica / Puissance Électrique / Potencia Eléctrica / Electric Power	W	1140
Potência Grupo Frigorífico / Puissance Groupe Frig. / Fridge Group Power	W	-
Tensão / Tension / Tension / Tension	V	230



**SAGI****VITRINES REFRIGERADAS VERTICAIS - OPORTUNIDADES**

VITRINES VERTICALES RÉFRIGÉRÉES - OCCASIONS

VITRINAS REFRIGERADAS VERTICALES - OPORTUNIDADES

VERTICAL REFRIGERATED SHOWCASE - OPPORTUNITIES

**2186.401E**

MODELO / MODÈLE / MODELO / MODEL CÓDIGO / CODE / CÓDIGO / CODE		KP6QV 2186.401E
<b>Preço / Prix / Precio / Price</b>	<b>€</b>	<b>6860.00</b>
Dimensões / Dimensions / Dimensiones	mm	600x645x 1840
Temperatura Refrigeração / Temp. Refroidissement / Temp. Enfriamiento / Cooling Temp.	°C	+2/+10
Humidade Relativa / Humidité / Humedad / Relative Humidity	%	70
Gás refrigerante / Gaz réfrigérant / Gas refrigerante / Refrig. gas		R404A
Descongelação / Décongélation / Descong. / Defrosting	A/M** (AR/GQ)	A (AR)
Refrigeração / Refrigeration / Refrigeracion / Cooling	S/V*	V
Dimensão prateleira / Dimensions grilles / Dimensiones rejillas / Grids dimensions	mm	490x470
Grelhas / Étagères / Estantes / Shelves	nr	5
Peso Líquido-Bruto / Poids Net-Brut / Peso Neto-Bruto / Net-Gross Weight	kg	178-188
Potência Elétrica / Puissance Électrique / Potencia Eléctrica / Electric Power	W	500
Potência Grupo Frigorífico / Puissance Groupe Frig. / Fridge Group Power	W	596
Tensão / Tension / Tension / Tension	V	230



MODELO / MODÈLE / MODELO / MODEL CÓDIGO / CODE / CÓDIGO / CODE		KD6QV 2186.401H	KD8QV 2186.446
<b>Preço / Prix / Precio / Price</b>	<b>€</b>	<b>8.993,00</b>	<b>9.897,00</b>
Dimensões / Dimensions / Dimensiones	mm	600x645x 1840	805x645x 1840
Temperatura Refrigeração / Temp. Refroidissement / Temp. Enfriamiento / Cooling Temp.	°C	-22/+5	(-22/+5)
Humidade Relativa / Humidité / Humedad / Relative Humidity	%	65 / 40	65/40
Gás refrigerante / Gaz réfrigérant / Gas refrigerante / Refrig. gas		R404A	R404A
Descongelação / Décongélation / Descong. / Defrosting	A/M** (AR/GQ)	A (GQ)	A (GQ)
Refrigeração / Refrigeration / Refrigeracion / Cooling	S/V*	V	V
Dimensão prateleira / Dimensions grilles / Dimensiones rejillas / Grids dimensions	mm	490x470	700x470
Grelhas / Étagères / Estantes / Shelves	nr	5	5
Peso Líquido-Bruto / Poids Net-Brut / Peso Neto-Bruto / Net-Gross Weight	kg	224-244	243/267
Potência Elétrica / Puissance Électrique / Potencia Eléctrica / Electric Power	W	1650	1250
Potência Grupo Frigorífico / Puissance Groupe Frig. / Fridge Group Power	W	1140	1140
Tensão / Tension / Tension / Tension	V	230	230

**2186.482**

MODELO / MODÈLE / MODELO / MODEL CÓDIGO / CODE / CÓDIGO / CODE		KP6Q 2186.482
<b>Preço / Prix / Precio / Price</b>	<b>€</b>	<b>6.860,00</b>
Dimensões / Dimensions / Dimensiones	mm	600x645x 1840
Temperatura / Température / Temperatura / Temperature	°C	+2/+10
Humidade Relativa / Humidité / Humedad / Relative Humidity	%	70
Gás refrigerante / Gaz réfrigérant / Gas refrigerante / Refrig. gas		R404A
Descongelação / Décongélation / Descong. / Defrosting	A/M** (AR/GQ)	A (AR)
Refrigeração / Refrigeration / Refrigeracion / Cooling	S/V*	V
Dimensão prateleira / Dimensions grilles / Dimensiones rejillas / Grids dimensions	mm	490x470
Grelhas / Étagères / Estantes / Shelves	nr	5
Peso Líquido-Bruto / Poids Net-Brut / Peso Neto-Bruto / Net-Gross Weight	kg	171-191
Potência / Puissance / Potencia / Power	W	500
Potência Grupo Frigorífico / Puissance Groupe Frig. / Fridge Group Power	W	596
Tensão / Tension / Tension / Tension	V	230



Syrio - Em forma cilíndrica de vidro temperado única e inovadora. (Modelos KP9 + KD9).



Unique et innovant compartiment cylindrique en verre trempé. (modèles KP9 + KD9).



Compartimento cilíndrico único e inovador en vidrio templado. (Modelos KP9 + KD9).



Unique and innovative cylindrical display compartment in tempered glass. (Models KP9 + KD9).



**Elegância em 360°**  
 Élegance en 360°  
 Elegancia en 360°  
 Elegance in 360°

MODELO / MODÈLE / MODELO / MODEL	KP9R	
CÓDIGO / CODE / CÓDIGO / CODE	2186.416	
<b>Preço / Prix / Precio / Price</b>	<b>€</b>	<b>13.377,00</b>
Dimensões / Dimensions / Dimensiones	mm	-x -x 1834
Diâmetro / Diamètre / Diámetro / Diameter	Ø mm	956
Volume / Volume / Volume / Volume	lt	790
Temperatura / Température / Temperatura / Temperature	°C	+2/+10
Humidade Relativa / Humidité / Humedad / Relative Humidity	%	70
Gás refrigerante / Gaz réfrigérant / Gas refrigerante / Refrig. gas		R-404A
Descongelação / Décongélation / Descong. / Defrosting	A/M** (AR/GQ)	A (AR)
Refrigeração / Refrigeration / Refrigeracion / Cooling	S/V*	V
Dimensão prateleira / Dim. grilles / Dim. rejillas / Gríds dimensions	mm	0 710x660
Grelhas / Étagères / Estantes / Shelves	nr	5
Peso Líquido-Bruto / Poids Net-Brut / Peso Neto-Bruto / Net-Gross Weight	kg	335-370
Potência / Puissance / Potência / Power	W	920
Tensão / Tension / Tension / Tension	V	230

\*V = Ventilada / Ventilé / Ventilada / Ventilated | S = Estática / Static / Estática / Static  
 \*\*A - Automático / Automatique / Automatico / Automatic - M - Manual / Manuel / Manual / Manual | (AR - Ar / Aire / Aire / Air | GQ - Gás Quente / Gaz Chaud / Gas Caliente / Hot Gas)

Peso máximo por prateleira = 15Kg  
 Peso máximo = pr estante 15 kg  
 Poids maximum par tablette = 15 kg  
 Maximum weight per shelf = 15Kg

**SQGI**

# LUXOR DOUBLE

**VITRINES REFRIGERADAS VERTICAIS**

VITRINES VERTICALES RÉFRIGÉRÉES

VITRINAS REFRIGERADAS VERTICALES

VERTICAL REFRIGERATED SHOWCASE



Vitrine construída totalmente em vidro temperado, serigrafado externamente. Iluminação LED. Estrutura inferior em aço especial anti-impressão digital sem orifícios visíveis. Pcb eletrônico de vidro preto com chaves e alarmes HACCP. Com 4 prateleiras de vidro temperado; sistema de abertura de flapdoor pneumático softmotion nas 2 aberturas. Ventilação refrigerada efetuada através de evaporador. Descongelção automática por ar.



Vitrine construite entièrement en verre trempé, sérigraphié à l'extérieur. Foudre à leds. Structure inférieure en acier spécial anti-empreintes digitales sans trous apparents. Carte électronique en verre noir avec clés et alarmes HACCP. Avec 4 tablettes en verre trempé; système d'ouverture pneumatique des volets softmotion dans les 2 ouvertures. Ventilation refroidie par évaporateur. Dégivrage automatique à l'air.



Vano expositor completamente de cristal templado con exterior serigrafado. Iluminación por led. Estructura inferior de acero especial antihuella, sin aletas frontales y laterales. Tarjeta electrónica de vidrio negro con teclas capacitivas y alarmas HACCP. Nr.4 estantes de cristal templado. Refrigeración ventilada por evaporador en la parte inferior de la estructura. Descongelación automática por aire.



Display compartment in tempered glass throughout, externally screen-silk printed. LED lighting. Special anti-fingerprint steel lower structure without holes in view. Black glass electronic pcb with capacitive keys and HACCP alarms. Nr.4 display shelves in tempered glass; softmotion pneumatic flapdoor opening system on the 2 openings. Ventil. refrigeration through evaporator; automatic defrosting by air.



reddot design award  
winner 2012



MODELO / MODÈLE / MODELO / MODEL	KP12G2	
CÓDIGO / CODE / CÓDIGO / CODE	2186.435	
<b>Preço / Prix / Precio / Price</b>	<b>€</b>	<b>11.352,00</b>
Dimensões / Dimensions / Dimensiones	mm	1200x660x1430
Volume / Volume / Volume / Volume	lt	536
Temperatura Ambiente / Température Ambiante / Temperatura Ambiente / Room Temperature	°C	30
Temperatura / Température / Temperatura / Temperature	°C	+2/+10
Humidade Relativa / Humidité / Humedad / Relative Humidity	%	70
Gás refrigerante / Gaz réfrigérant / Gas refrigerante / Refrig. gas		R290
Descongelção / Décongélation / Descong. / Defrosting	A/M** (AR/GQ)	A
Refrigeração / Refrigeration / Refrigeracion / Cooling	S/V*	V
Dimensão prateleira / Dim. grilles / Dim. rejillas / Grids dimensions	mm	1070x410
Grelhas / Étagères / Estantes / Shelves	nr	4
Peso Líquido-Bruto / Poids Net-Brut / Peso Neto-Bruto / Net-Gross Weight	kg	260-292
Potência Elétrica / Puissance Électrique / Potencia Eléctrica / Electric Power	kW	0,91
Potência Grupo Frigorífico / Puissance Groupe Frigo / Potencia Grupo Frigorífico / Cooling Group Power	W	1250
Tensão / Tension / Tension / Tension	V	230

\*V = Ventilada / Ventilé / Ventilada / Ventilated | S = Estática / Static / Estática / Static

\*\*A - Automático / Automatique / Automatic / Automatic - M - Manual / Manuel / Manual / Manual | (AR - Ar / Aire / Aire / Air | GQ - Gás Quente / Gaz Chaud / Gas Caliente / Hot Gas)

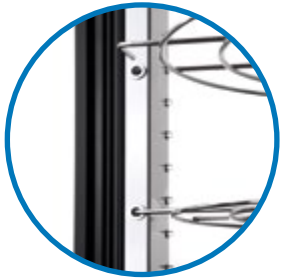

Prateleiras desmontáveis  
Étagères démontables  
Estantes desmontables  
Removable shelves



Portas traseiras de vidro temperado  
Portes arrière en verre trempé  
Puertas traseras de cristal templado  
Rear tempered glass doors



MODELO / MODÈLE / MODELO / MODEL		NEUTRA UDI	NEUTRA UDI
CÓDIGO / CODE / CÓDIGO / CODE		3097.200	3097.205
<b>Preço / Prix / Precio / Price</b>	€	<b>835,00</b>	<b>623,00</b>
Dimensões / Dimensions / Dimensiones	mm	435x435x710	435x435x710
Nº Estantes / Nº Étagères / Nº Estantes / Shelves No.	nº	5	5
Medida Estantes / Mesure étagères / Medida estantes / Shelves mesure	mm	Ø 350	Ø 350
Leds/ Leds / Leds / Leds	nº	2	-
Vidro / Verre / Vidrio / Glass		Temp	Temp
Peso Líquido-Bruto / Poids Net-Brut / Peso Neto-Bruto / Net-Gross Weight	kg	30	30
Tensão / Tension / Tensión / Tension	V	230	-



MODELO / MODÈLE / MODELO / MODEL		AQUECIDA UDI
CÓDIGO / CODE / CÓDIGO / CODE		3097.210
<b>Preço / Prix / Precio / Price</b>	€	<b>1.114,00</b>
Dimensões / Dimensions / Dimensiones	mm	435x435x970
Nº Estantes / Nº Étagères / Nº Estantes / Shelves No.	nº	5
Medida Estantes / Mesure étagères / Medida estantes / Shelves mesure	mm	Ø 350
Leds/ Leds / Leds / Leds	nº	2
Vidro / Verre / Vidrio / Glass		Temp
Temperatura / Température / Temperatura / Température	°C	+90
Turbo ventiladores / Turbo ventilateurs / Turbo ventiladores / Fans turbo		√
Ventiladores / Ventilateurs / Ventiladores / Fans	nº	3
Evaporação ventilada / Évaporation ventilé / Evaporación ventilada / Ventilated evaporation		√
Peso Líquido-Bruto / Poids Net-Brut / Peso Neto-Bruto / Net-Gross Weight	kg	30
Tensão / Tension / Tensión / Tension	V	230



UDIfri

**VITRINES EXPOSITORAS E REFRIGERADAS**  
VITRINES EXPOSANTS ET RÉFRIGÉRÉES  
VITRINAS EXPOSITORAS Y REFRIGERADAS  
EXHIBITORS AND REFRIGERATED SHOWCASES



VENTILADO



+4°C/+8°C



INCLUIDO



SOBREMESAS



SANDWICH



SUSHI



SALADAS



BUFFET



FRUTA



BEBIDAS



SNACKS



CHOCOLATE

Fabricada totalmente com vidros temperados  
Entièrement construit en verre trempé  
Totalmente construida con cristales templados  
Completely built with tempered glasses



**UDI 7**



MODELO / MODÈLE / MODELO / MODEL  
CÓDIGO / CODE / CÓDIGO / CODE

UDI 7

3097.220

Preço / Prix / Precio / Price

€

2.670,00

Dimensões / Dimensions / Dimensiones

mm

710x535x900

Nº Estantes / N° Étagères / N° Estantes / Shelves No.

nº

3

Medida Estantes / Mesure étagères / Medida estantes / Shelves mesure

mm

695x250

Leds/ Leds / Leds / Leds

nº

4

Temperatura / Température / Temperatura / Temperature

°C

+4/+8

Evaporação ventilada / Évaporation ventilé / Evaporación ventilada / Ventilated evaporation

V

V

Tensão / Tension / Tensión / Tension

V

230

 DELUXE 92/122/152  
PSV FRENTE / FRONT

 NOVO  
NOUVEAU  
NUEVO  
NEW

MODELO / MODÈLE / MODELO / MODEL	UDDELUXE 92 PSV	
CÓDIGO / CODE / CÓDIGO / CODE	2829.954	
<b>Preço / Prix / Precio / Price</b>	<b>€</b>	<b>3.208,00</b>
Dimensões / Dimensions / Dimensiones	mm	900x740x1200
Nº Estantes / Nº Étagères / Nº Estantes / Shelves No.	nº	2
Medida Estantes / Mesure étagères / Medida estantes / Shelves mesure	mm	738x278 738x318
Iluminação / Éclairage / Iluminación / Lighting		LED
Temperatura / Température / Temperatura / Temperature	°C	+2/+10
Evaporação ventilada / Évaporation ventilé / Evaporación ventilada / Ventilated evaporation		V
Gás refrigerante / Gaz réfrigérant / Gas refrigerante / Refrig. gas		R290
Descongelamento / Décongélation / Descong. / Defrosting		Auto
Peso Líquido-Bruto / Poids Net-Brut / Peso Neto-Bruto / Net-Gross Weight	kg	155-195
Potência / Puissance / Potência / Power	W	400
Tensão / Tension / Tensión / Tension	V	230

 NOVO  
NOUVEAU  
NUEVO  
NEW

MODELO / MODÈLE / MODELO / MODEL	UDDELUXE 122 PSV	
CÓDIGO / CODE / CÓDIGO / CODE	2829.956	
<b>Preço / Prix / Precio / Price</b>	<b>€</b>	<b>3.500,00</b>
Dimensões / Dimensions / Dimensiones	mm	1200x740x1200
Nº Estantes / Nº Étagères / Nº Estantes / Shelves No.	nº	2
Medida Estantes / Mesure étagères / Medida estantes / Shelves mesure	mm	1038x278 1038x318
Iluminação / Éclairage / Iluminación / Lighting		LED
Temperatura / Température / Temperatura / Temperature	°C	+2/+10
Evaporação ventilada / Évaporation ventilé / Evaporación ventilada / Ventilated evaporation		V
Gás refrigerante / Gaz réfrigérant / Gas refrigerante / Refrig. gas		R290
Descongelamento / Décongélation / Descong. / Defrosting		Auto
Peso Líquido-Bruto / Poids Net-Brut / Peso Neto-Bruto / Net-Gross Weight	kg	185-230
Potência / Puissance / Potência / Power	W	445
Tensão / Tension / Tensión / Tension	V	230

 NOVO  
NOUVEAU  
NUEVO  
NEW



MODELO / MODÈLE / MODELO / MODEL	UDDELUXE 152 PSV	
CÓDIGO / CODE / CÓDIGO / CODE	2829.958	
<b>Preço / Prix / Precio / Price</b>	<b>€</b>	<b>4.003,00</b>
Dimensões / Dimensions / Dimensiones	mm	1500x740x1200
Nº Estantes / Nº Étagères / Nº Estantes / Shelves No.	nº	2
Medida Estantes / Mesure étagères / Medida estantes / Shelves mesure	mm	1338x278 1338x318
Iluminação / Éclairage / Iluminación / Lighting		LED
Temperatura / Température / Temperatura / Temperature	°C	+2/+10
Evaporação ventilada / Évaporation ventilé / Evaporación ventilada / Ventilated evaporation		V
Gás refrigerante / Gaz réfrigérant / Gas refrigerante / Refrig. gas		R290
Descongelamento / Décongélation / Descong. / Defrosting		Auto
Peso Líquido-Bruto / Poids Net-Brut / Peso Neto-Bruto / Net-Gross Weight	kg	220-270
Potência / Puissance / Potência / Power	W	515
Tensão / Tension / Tensión / Tension	V	230



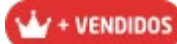

MODELO / MODÈLE / MODELO / MODEL CÓDIGO / CODE / CÓDIGO / CODE		UD-1220 PV 2828.805
<b>Preço / Prix / Precio / Price</b>	€	<b>862,00</b>
Dimensões / Dimensions / Dimensiones	mm	595x 640x 1310
Volume / Volume / Volume / Volume	lt	215
Temperatura / Température / Temperatura / Temperature	°C	+1/+10
Gás refrigerante / Gaz réfrigérant / Gas refrigerante / Refrig, gas		R600
Refrigeração / Refrigeration / Refrigeracion / Cooling	S/V*	V*
Grelhas / Étagères / Estantes / Shelves	nr	3
Peso Líquido-Bruto / Poids Net-Brut / Peso Neto-Bruto / Net-Gross Weight	kg	58-65
Potência / Puissance / Potência / Power	W	250
Tensão / Tension / Tension / Tension	V	230

 + VENDIDOS

 + VENDIDOS

**2828.820**

**2828.820B**

MODELO / MODÈLE / MODELO / MODEL CÓDIGO / CODE / CÓDIGO / CODE		UD-1380 PV LEDES 2828.820	UD-1380 PV LEDES 2828.820B
<b>Preço / Prix / Precio / Price</b>	€	<b>900,00</b>	<b>928,00</b>
Dimensões / Dimensions / Dimensiones	mm	595x 640x 1840	595x 640x 1840
Volume / Volume / Volume / Volume	lt	372	372
Temperatura / Température / Temperatura / Temperature	°C	+1/+10	+1/+10
Gás refrigerante / Gaz réfrigérant / Gas refrigerante / Refrig, gas		R600	R600
Refrigeração / Refrigeration / Refrigeracion / Cooling	S/V*	V*	V*
Grelhas / Étagères / Estantes / Shelves	nr	5	5
Peso Líquido-Bruto / Poids Net-Brut / Peso Neto-Bruto / Net-Gross Weight	kg	74-81	74-81
Potência / Puissance / Potência / Power	W	350	350
Tensão / Tension / Tension / Tension	V	230	230



MODELO / MODÈLE / MODELO / MODEL CÓDIGO / CODE / CÓDIGO / CODE		UD 2380 PV (2 PORTAS) 2828.845
<b>Preço / Prix / Precio / Price</b>	€	<b>936,00</b>
Dimensões / Dimensions / Dimensiones	mm	595x 640x 1840
Volume / Volume / Volume / Volume	lt	372
Temperatura / Température / Temperatura / Temperature	°C	+1/+10
Gás refrigerante / Gaz réfrigérant / Gas refrigerante / Refrig, gas		R600
Refrigeração / Refrigeration / Refrigeracion / Cooling	S/V*	V*
Grelhas / Étagères / Estantes / Shelves	nr	5
Peso Líquido-Bruto / Poids Net-Brut / Peso Neto-Bruto / Net-Gross Weight	kg	81
Potência / Puissance / Potência / Power	W	360
Tensão / Tension / Tension / Tension	V	230



MODELO / MODÈLE / MODELO / MODEL CÓDIGO / CODE / CÓDIGO / CODE		UD-1370 PO 2828.830
<b>Preço / Prix / Precio / Price</b>	€	<b>949,00</b>
Dimensões / Dimensions / Dimensiones	mm	595x 640x 1840
Volume / Volume / Volume / Volume	lt	372
Temperatura / Température / Temperatura / Temperature	°C	+1/+10
Gás refrigerante / Gaz réfrigérant / Gas refrigerante / Refrig, gas		R600
Refrigeração / Refrigeration / Refrigeracion / Cooling	S/V*	V*
Grelhas / Étagères / Estantes / Shelves	nr	5
Peso Líquido-Bruto / Poids Net-Brut / Peso Neto-Bruto / Net-Gross Weight	kg	64-70
Potência / Puissance / Potência / Power	W	350
Tensão / Tension / Tension / Tension	V	230

**PRETO / BLACK  
2828.822**
**30,00**

**BRANCO / WHITE  
2828.821**
**24,00**





udi fri

ARMÁRIOS VERTICAIS DE CONSERVAÇÃO COM DISPLAY

ARMOIRES VERTICALES CONSERVATION AVEC AFICHEUR

ARMARIOS VERTICALES CONSERVACIÓN CON DISPLAY

VERTICAL CONSERVATION COOLERS WITH DISPLAY



NOVO  
NOUVEAU  
NUEVO  
NEW



MODELO / MODÈLE / MODELO / MODEL	UD-1300 PVD	
CÓDIGO / CODE / CÓDIGO / CODE	2828.812	
<b>Preço / Prix / Precio / Price</b>	€	<b>892,00</b>
Dimensões / Dimensions / Dimensiones	mm	595x 640x 1780
Volume / Volume / Volume / Volume	lt	260/290
Temperatura / Température / Temperatura / Temperature	°C	+1/+10
Gás refrigerante / Gaz réfrigérant / Gas refrigerante / Refrig. gas		R600A
Refrigeração / Refrigeration / Refrigeracion / Cooling	S/V*	V*
Grelhas / Étagères / Estantes / Shelves	nr	4
Peso Líquido-Bruto / Poids Net-Brut / Peso Neto-Bruto / Net-Gross Weight	kg	74-80
Potência / Puissance / Potência / Power	W	300
Tensão / Tension / Tension / Tension	V	230



2828.825



2828.850

MODELO / MODÈLE / MODELO / MODEL	UD-1380 PVD COM LED		UD-2380 PVD
CÓDIGO / CODE / CÓDIGO / CODE	2828.825		2828.850
<b>Preço / Prix / Precio / Price</b>	€	<b>941,00</b>	<b>1.056,00</b>
Dimensões / Dimensions / Dimensiones	mm	595x 640x 1980	595x 640x 1980
Volume / Volume / Volume / Volume	lt	372	372
Temperatura / Température / Temperatura / Temperature	°C	+1/+10	+1/+10
Gás refrigerante / Gaz réfrigérant / Gas refrigerante / Refrig. gas		R600	R600
Refrigeração / Refrigeration / Refrigeracion / Cooling	S/V*	V	V
Grelhas / Étagères / Estantes / Shelves	nr	5	5
Peso Líquido-Bruto / Poids Net-Brut / Peso Neto-Bruto / Net-Gross Weight	kg	78-85	79-86
Potência / Puissance / Potência / Power	W	370	370
Tensão / Tension / Tension / Tension	V	230	230



MODELO / MODÈLE / MODELO / MODEL	UD-1440 PVD	
CÓDIGO / CODE / CÓDIGO / CODE	2828.828	
<b>Preço / Prix / Precio / Price</b>	€	<b>1.112,00</b>
Dimensões / Dimensions / Dimensiones	mm	680x 665x 2090
Volume / Volume / Volume / Volume	lt	438
Temperatura / Température / Temperatura / Temperature	°C	+1/+10
Gás refrigerante / Gaz réfrigérant / Gas refrigerante / Refrig. gas		R600
Refrigeração / Refrigeration / Refrigeracion / Cooling	S/V*	V
Grelhas / Étagères / Estantes / Shelves	nr	5
Peso Líquido-Bruto / Poids Net-Brut / Peso Neto-Bruto / Net-Gross Weight	kg	101-112
Potência / Puissance / Potência / Power	W	390
Tensão / Tension / Tension / Tension	V	230

\*V = Ventilada / Ventilé / Ventilada / Ventilated | S = Estática / Static / Estática / Static



confirmar disponibilidade  
confirmer la disponibilité  
confirmar la disponibilidad  
confirm the availability



MODELO / MODÈLE / MODELO / MODEL		PR 40
CÓDIGO / CODE / CÓDIGO / CODE		2828.162
<b>Preço / Prix / Precio / Price</b>	<b>€</b>	<b>1.485,00</b>
Dimensões / Dimensions / Dimensiones	mm	600x 610x 1865
Volume / Volume / Volume / Volume	lt	380
Temperatura / Température / Temperatura / Temperature	°C	+3/+8
Gás refrigerante / Gaz réfrigérant / Gas refrigerante / Refrig, gas		R134A
Refrigeração / Refrigeration / Refrigeracion / Cooling	S/V*	V*
Grelhas / Étagères / Estantes / Shelves	nr	4+1
Peso Líquido-Bruto / Poids Net-Brut / Peso Neto-Bruto / Net-Gross Weight	kg	76
Potência / Puissance / Potência / Power	W	160
Tensão / Tension / Tension / Tension	V	230



MODELO / MODÈLE / MODELO / MODEL		EXPO 500 PT
CÓDIGO / CODE / CÓDIGO / CODE		2828.172
<b>Preço / Prix / Precio / Price</b>	<b>€</b>	<b>2.079,00</b>
Dimensões / Dimensions / Dimensiones	mm	558x 668x 1990
Volume / Volume / Volume / Volume	lt	472
Temperatura / Température / Temperatura / Temperature	°C	+2/+8
Gás refrigerante / Gaz réfrigérant / Gas refrigerante / Refrig, gas		R134A
Refrigeração / Refrigeration / Refrigeracion / Cooling	S/V*	V*
Grelhas / Étagères / Estantes / Shelves	nr	5
Peso Líquido-Bruto / Poids Net-Brut / Peso Neto-Bruto / Net-Gross Weight	kg	118
Potência / Puissance / Potência / Power	W	350
Tensão / Tension / Tension / Tension	V	230



MODELO / MODÈLE / MODELO / MODEL		EXPO 1100 PT
CÓDIGO / CODE / CÓDIGO / CODE		2828.174
<b>Preço / Prix / Precio / Price</b>	<b>€</b>	<b>3.893,00</b>
Dimensões / Dimensions / Dimensiones	mm	1346x 765x 1990
Volume / Volume / Volume / Volume	lt	1047
Temperatura / Température / Temperatura / Temperature	°C	+2/+8
Gás refrigerante / Gaz réfrigérant / Gas refrigerante / Refrig, gas		R134A
Refrigeração / Refrigeration / Refrigeracion / Cooling	S/V*	V*
Grelhas / Étagères / Estantes / Shelves	nr	5+5
Peso Líquido-Bruto / Poids Net-Brut / Peso Neto-Bruto / Net-Gross Weight	kg	206
Potência / Puissance / Potência / Power	W	800
Tensão / Tension / Tension / Tension	V	230



udi fri

**MINI FRIGORIFICO CONSERVAÇÃO / CONGELAÇÃO**

MINI RÉFRIGÉRATEUR CONSERVATION / CONGELATION

MINI REFRIGERADOR CONSERVACIÓN / CONGELACIÓN

MINI REFRIGERATOR CONSERVATION / FREEZER



**NOVO  
NOUVEAU  
NUEVO  
NEW**



MODELO / MODÈLE / MODELO / MODEL CÓDIGO / CODE / CÓDIGO / CODE		MINI CONGELADOR 31 LT 2230.912
<b>Preço / Prix / Precio / Price</b>	€	<b>383,00</b>
Dimensões / Dimensions / Dimensiones	mm	473x448x505
Volume / Volume / Volume / Volume	lt	31
Refrigeração / Refrigeration / Refrigeracion / Cooling	S/V*	S
Grelhas / Étagères / Estantes / Shelves	nr	1
Peso Líquido-Bruto / Poids Net-Brut / Peso Neto-Bruto / Net-Gross Weight	kg	15,3-16,6
Tensão / Tension / Tension / Tension	V	230

**NOVO  
NOUVEAU  
NUEVO  
NEW**



MODELO / MODÈLE / MODELO / MODEL CÓDIGO / CODE / CÓDIGO / CODE		MINI FRIGORIFICO 45 LT 2230.914
<b>Preço / Prix / Precio / Price</b>	€	<b>343,00</b>
Dimensões / Dimensions / Dimensiones	mm	455x446x512
Volume / Volume / Volume / Volume	lt	45
Refrigeração / Refrigeration / Refrigeracion / Cooling	S/V*	S
Grelhas / Étagères / Estantes / Shelves	nr	1
Peso Líquido-Bruto / Poids Net-Brut / Peso Neto-Bruto / Net-Gross Weight	kg	13,46-15
Tensão / Tension / Tension / Tension	V	230



**NOVO**  
**NOUVEAU**  
**NUEVO**  
**NEW**



MODELO / MODÈLE / MODELO / MODEL		UD-1300 PV
CÓDIGO / CODE / CÓDIGO / CODE		2828.810
<b>Preço / Prix / Precio / Price</b>	<b>€</b>	<b>870,00</b>
Dimensões / Dimensions / Dimensiones	mm	595x 640x 1640
Volume / Volume / Volume / Volume	lt	260/290
Temperatura / Température / Temperatura / Temperature	°C	+1/+10
Gás refrigerante / Gaz réfrigérant / Gas refrigerante / Refrig, gas		R600A
Refrigeração / Refrigeration / Refrigeracion / Cooling	S/V*	V*
Grelhas / Étagères / Estantes / Shelves	nr	4
Peso Líquido-Bruto / Poids Net-Brut / Peso Neto-Bruto / Net-Gross Weight	kg	68-74
Potência / Puissance / Potência / Power	W	290
Tensão / Tension / Tension / Tension	V	230

**NOVO**  
**NOUVEAU**  
**NUEVO**  
**NEW**



MODELO / MODÈLE / MODELO / MODEL		UD-1300 PO
CÓDIGO / CODE / CÓDIGO / CODE		2828.814
<b>Preço / Prix / Precio / Price</b>	<b>€</b>	<b>865,00</b>
Dimensões / Dimensions / Dimensiones	mm	595x 640x 1640
Volume / Volume / Volume / Volume	lt	260/290
Temperatura / Température / Temperatura / Temperature	°C	+1/+10
Gás refrigerante / Gaz réfrigérant / Gas refrigerante / Refrig, gas		R600A
Refrigeração / Refrigeration / Refrigeracion / Cooling	S/V*	V*
Grelhas / Étagères / Estantes / Shelves	nr	4
Peso Líquido-Bruto / Poids Net-Brut / Peso Neto-Bruto / Net-Gross Weight	kg	59-65
Potência / Puissance / Potência / Power	W	290
Tensão / Tension / Tension / Tension	V	230

\*V = Ventilada / Ventilé / Ventilada / Ventilated | S = Estática / Static / Estática / Static



UDIfri

**ARMÁRIOS VERTICAIS DE CONSERVAÇÃO BIG**  
 ARMOIRES VERTICALES CONSERVATION BIG  
 ARMARIOS VERTICALES CONSERVACIÓN BIG  
 BIG VERTICAL CONSERVATION COOLERS



**NOVO**  
**NOUVEAU**  
**NUEVO**  
**NEW**

**BIG**



MODELO / MODÈLE / MODELO / MODEL		UD-1420 PV
CÓDIGO / CODE / CÓDIGO / CODE		2828.880
<b>Preço / Prix / Precio / Price</b>	<b>€</b>	<b>1.072,00</b>
Dimensões / Dimensions / Dimensiones	mm	595x680x2038
Volume / Volume / Volume / Volume	lt	263/420
Temperatura / Température / Temperatura / Temperature	°C	+1/+10
Gás refrigerante / Gaz réfrigérant / Gas refrigerante / Refrig. gas		R600A
Refrigeração / Refrigeration / Refrigeracion / Cooling	S/V*	V*
Grelhas / Étagères / Estantes / Shelves	nr	5
Peso Líquido-Bruto / Poids Net-Brut / Peso Neto-Bruto / Net-Gross Weight	kg	98-108,5
Potência / Puissance / Potência / Power	W	250
Tensão / Tension / Tension / Tension	V	230

**NOVO**  
**NOUVEAU**  
**NUEVO**  
**NEW**

**BIG**



MODELO / MODÈLE / MODELO / MODEL		UD-1700 PV
CÓDIGO / CODE / CÓDIGO / CODE		2828.882
<b>Preço / Prix / Precio / Price</b>	<b>€</b>	<b>1.860,00</b>
Dimensões / Dimensions / Dimensiones	mm	780x705x2202
Volume / Volume / Volume / Volume	lt	683
Temperatura / Température / Temperatura / Temperature	°C	+1/+10
Gás refrigerante / Gaz réfrigérant / Gas refrigerante / Refrig. gas		R290
Refrigeração / Refrigeration / Refrigeracion / Cooling	S/V*	V*
Grelhas / Étagères / Estantes / Shelves	nr	5
Peso Líquido-Bruto / Poids Net-Brut / Peso Neto-Bruto / Net-Gross Weight	kg	140,5-151
Potência / Puissance / Potência / Power	W	425
Tensão / Tension / Tension / Tension	V	230

\*V = Ventilada / Ventilé / Ventilada / Ventilated | S = Estática / Static / Estática / Static





MODELO / MODÈLE / MODELO / MODEL	UD880/1- PV	
CÓDIGO / CODE / CÓDIGO / CODE	2829.642	
<b>Preço / Prix / Precio / Price</b>	<b>€</b>	<b>2.231,00</b>
Dimensões / Dimensions / Dimensiones	mm	870x605x1981
Volume / Volume / Volume / Volume	lt	590
Temperatura / Température / Temperatura / Temperature	°C	+4/+10
Gás refrigerante / Gaz réfrigérant / Gas refrigerante / Refrig. gas		R290
Grelhas / Étagères / Estantes / Shelves	nr	10
Peso Líquido-Bruto / Poids Net-Brut / Peso Neto-Bruto / Net-Gross Weight	kg	112-127
Potência / Puissance / Potência / Power	W	430
Tensão / Tension / Tension / Tension	V	230



MODELO / MODÈLE / MODELO / MODEL	UD801/1- P	
CÓDIGO / CODE / CÓDIGO / CODE	2829.644	
<b>Preço / Prix / Precio / Price</b>	<b>€</b>	<b>2.518,00</b>
Dimensões / Dimensions / Dimensiones	mm	1000x700x2020
Volume / Volume / Volume / Volume	lt	800
Temperatura / Température / Temperatura / Temperature	°C	+4/+10
Gás refrigerante / Gaz réfrigérant / Gas refrigerante / Refrig. gas		R290
Grelhas / Étagères / Estantes / Shelves	nr	8
Peso Líquido-Bruto / Poids Net-Brut / Peso Neto-Bruto / Net-Gross Weight	kg	130-147
Potência / Puissance / Potência / Power	W	750
Tensão / Tension / Tension / Tension	V	230



udifri

**ARMÁRIOS VERTICAIS DE CONGELAÇÃO**  
 ARMOIRES VERTICALES CONGELATION  
 ARMARIOS VERTICALES CONGELAMIENTO  
 VERTICAL FREEZING COOLERS



**NOVO  
 NOUVEAU  
 NUEVO  
 NEW**



MODELO / MODÈLE / MODELO / MODEL	UD-1270-7G BRANCO	
CÓDIGO / CODE / CÓDIGO / CODE	2828.894	
<b>Preço / Prix / Precio / Price</b>	<b>€</b>	<b>885,00</b>
Dimensões / Dimensions / Dimensiones	mm	595x 655x 1765
Volume / Volume / Volume / Volume	lt	258/265
Temperatura / Température / Temperatura / Temperature	°C	-18/-25
Gás refrigerante / Gaz réfrigérant / Gas refrigerante / Refrig. gas		R600A
Refrigeração / Refrigeration / Refrigeracion / Cooling	S/V*	S
Gavetas / Tiroirs / Cajones / Drawers	nr	7
Peso Líquido-Bruto / Poids Net-Brut / Peso Neto-Bruto / Net-Gross Weight	kg	60-72
Potência / Puissance / Potência / Power	W	48
Tensão / Tension / Tension / Tension	V	230

\*V = Ventilada / Ventilé / Ventilada / Ventilated | S = Estática / Static / Estática / Static



MODELO / MODÈLE / MODELO / MODEL CÓDIGO / CODE / CÓDIGO / CODE		SLDG -750 P.DESL. 2828.900
<b>Preço / Prix / Precio / Price</b>	<b>€</b>	<b>2.153,00</b>
Dimensões / Dimensions / Dimensiones	mm	1110x 822x 2000
Volume / Volume / Volume / Volume	lt	988,5
Temperatura / Température / Temperatura / Temperature	°C	+1/+10
Refrigeração / Refrigeration / Refrigeracion / Cooling	S/V*	V
Grelhas / Étagères / Estantes / Shelves	nr	5
Peso Líquido-Bruto / Poids Net-Brut / Peso Neto-Bruto / Net-Gross Weight	kg	171-186
Potência / Puissance / Potência / Power	W	850
Tensão / Tension / Tension / Tension	V	230



MODELO / MODÈLE / MODELO / MODEL CÓDIGO / CODE / CÓDIGO / CODE		SLDG -700 P.DESL. 2828.906
<b>Preço / Prix / Precio / Price</b>	<b>€</b>	<b>2.265,00</b>
Dimensões / Dimensions / Dimensiones	mm	1000x 742x 2000
Volume / Volume / Volume / Volume	lt	771
Temperatura / Température / Temperatura / Temperature	°C	+1/+10
Refrigeração / Refrigeration / Refrigeracion / Cooling	S/V*	V
Grelhas / Étagères / Estantes / Shelves	nr	5x2
Peso Líquido-Bruto / Poids Net-Brut / Peso Neto-Bruto / Net-Gross Weight	kg	150-160
Potência / Puissance / Potência / Power	W	700-730
Tensão / Tension / Tension / Tension	V	230

**NOVO  
NOUVEAU  
NUEVO  
NEW**



MODELO / MODÈLE / MODELO / MODEL CÓDIGO / CODE / CÓDIGO / CODE		SLDG -700 P.DESL. 2828.906B
<b>Preço / Prix / Precio / Price</b>	<b>€</b>	<b>2.298,00</b>
Dimensões / Dimensions / Dimensiones	mm	1000x 742x 2000
Volume / Volume / Volume / Volume	lt	771
Temperatura / Température / Temperatura / Temperature	°C	+1/+10
Refrigeração / Refrigeration / Refrigeracion / Cooling	S/V*	V
Grelhas / Étagères / Estantes / Shelves	nr	5x2
Peso Líquido-Bruto / Poids Net-Brut / Peso Neto-Bruto / Net-Gross Weight	kg	150-160
Potência / Puissance / Potência / Power	W	700-730
Tensão / Tension / Tension / Tension	V	230

V = Ventilada / Ventilé / Ventilada / Ventilated | S = Estática / Static / Estática / Static

SLDG - Termómetro analógico + Prateleira reforçada. / Thermomètre analogique + Forcé shelf / Termometro analogico + Estante reforçada / Analogic thermometer + Forcé shelf





udi fri



MODELO / MODÈLE / MODELO / MODEL	UD - 2800 PV/DD	
CÓDIGO / CODE / CÓDIGO / CODE	2828.840	
<b>Preço / Prix / Precio / Price</b>	<b>€</b>	<b>2.093,00</b>
Dimensões / Dimensions / Dimensiones	mm	1190x640x1980
Volume / Volume / Volume / Volume	lt	372x2
Temperatura / Température / Temperatura / Temperature	°C	+1/+10
Gás refrigerante / Gaz réfrigérant / Gas refrigerante / Refrig. gas		R600
Refrigeração / Refrigeration / Refrigeracion / Cooling	S/V*	V
Grelhas / Étagères / Estantes / Shelves	nr	5+5
Peso Líquido-Bruto / Poids Net-Brut / Peso Neto-Bruto / Net-Gross Weight	kg	154-166
Potência / Puissance / Potência / Power	w	730
Tensão / Tension / Tension / Tension	v	230

**NOVO**  
**NOUVEAU**  
**NUEVO**  
**NEW**



MODELO / MODÈLE / MODELO / MODEL	UD - 1900 PVDD	
CÓDIGO / CODE / CÓDIGO / CODE	2828.972	
<b>Preço / Prix / Precio / Price</b>	<b>€</b>	<b>2.299,00</b>
Dimensões / Dimensions / Dimensiones	mm	900x 742x 2102
Volume / Volume / Volume / Volume	lt	780
Temperatura / Température / Temperatura / Temperature	°C	+1/+10
Gás refrigerante / Gaz réfrigérant / Gas refrigerante / Refrig. gas		R290
Refrigeração / Refrigeration / Refrigeracion / Cooling	S/V*	V
Grelhas / Étagères / Estantes / Shelves	nr	5
Peso Líquido-Bruto / Poids Net-Brut / Peso Neto-Bruto / Net-Gross Weight	kg	160-174
Potência / Puissance / Potência / Power	w	1000
Tensão / Tension / Tension / Tension	v	230



MODELO / MODÈLE / MODELO / MODEL	SLDG 700 PPIVOT	SLDG 750 M PPIVOT	
CÓDIGO / CODE / CÓDIGO / CODE	2828.907	2828.905	
<b>Preço / Prix / Precio / Price</b>	<b>€</b>	<b>2.480,00</b>	<b>2.499,00</b>
Dimensões / Dimensions / Dimensiones	mm	1000x740x2010	1110x820x2010
Volume / Volume / Volume / Volume	lt	760	875
Temperatura / Température / Temperatura / Temperature	°C	+1/+10	+1/+10
Gás refrigerante / Gaz réfrigérant / Gas refrigerante / Refrig. gas		R600	R600
Refrigeração / Refrigeration / Refrigeracion / Cooling	S/V*	V	V
Grelhas / Étagères / Estantes / Shelves	nr	4+1	4+1
Peso Líquido-Bruto / Poids Net-Brut / Peso Neto-Bruto / Net-Gross Weight	kg	176	186
Potência / Puissance / Potência / Power	w	700	800
Tensão / Tension / Tension / Tension	v	230	230

**NOVO**  
**NOUVEAU**  
**NUEVO**  
**NEW**



MODELO / MODÈLE / MODELO / MODEL	UD-1200 PV/DD DESLIZ.	
CÓDIGO / CODE / CÓDIGO / CODE	2828.974	
<b>Preço / Prix / Precio / Price</b>	<b>€</b>	<b>2.190,00</b>
Dimensões / Dimensions / Dimensiones	mm	1200x742x2000
Volume / Volume / Volume / Volume	lt	645
Temperatura / Température / Temperatura / Temperature	°C	+1/+10
Gás refrigerante / Gaz réfrigérant / Gas refrigerante / Refrig. gas		R290
Refrigeração / Refrigeration / Refrigeracion / Cooling	S/V*	V
Grelhas / Étagères / Estantes / Shelves	nr	5
Peso Líquido-Bruto / Poids Net-Brut / Peso Neto-Bruto / Net-Gross Weight	kg	164-178
Potência / Puissance / Potência / Power	w	1000
Tensão / Tension / Tension / Tension	v	230

V = Ventilada / Ventilé / Ventilada / Ventilated | S = Estática / Static / Estática / Static  
 SLDG - Termómetro analógico + Prateleira reforçada. / Thermomètre analogique + Forced shelf / Termometro analogico + Estante reforçada / Analogic thermometer + Forced shelf



MODELO / MODÈLE / MODELO / MODEL CÓDIGO / CODE / CÓDIGO / CODE		UDB 45 PV 2828.868
<b>Preço / Prix / Precio / Price</b>	€	<b>693,00</b>
Dimensões / Dimensions / Dimensiones	mm	570x505x485
Volume / Volume / Volume / Volume	lt	45
Temperatura / Température / Temperatura / Temperature	°c	-12/-22
Gás refrigerante / Gaz réfrigérant / Gas refrigerante / Refrig, gas		R600A
Refrigeração / Refrigeration / Refrigeracion / Cooling		mecânico
Grelhas / Étagères / Estantes / Shelves	nr	1
Peso Líquido-Bruto / Poids Net-Brut / Peso Neto-Bruto / Net-Gross Weight	kg	31,5-35,5
Potência / Puissance / Potência / Power	W	150
Tensão / Tension / Tension / Tension	V	230



MODELO / MODÈLE / MODELO / MODEL CÓDIGO / CODE / CÓDIGO / CODE		UDB 1370 PO 2828.865
<b>Preço / Prix / Precio / Price</b>	€	<b>1.044,00</b>
Dimensões / Dimensions / Dimensiones	mm	595x640x1840
Volume / Volume / Volume / Volume	lt	300
Temperatura / Température / Temperatura / Temperature	°c	-12/-22
Gás refrigerante / Gaz réfrigérant / Gas refrigerante / Refrig, gas		R290
Refrigeração / Refrigeration / Refrigeracion / Cooling	S/V*	V
Grelhas / Étagères / Estantes / Shelves	nr	6
Peso Bruto / Poids Brut / Peso Bruto / Gross Weight	kg	80
Potência / Puissance / Potência / Power	W	270
Tensão / Tension / Tension / Tension	V	230

**NOVO  
NOUVEAU  
NUEVO  
NEW**



MODELO / MODÈLE / MODELO / MODEL CÓDIGO / CODE / CÓDIGO / CODE		UDB 1370 PV 2828.870	UDB 1370 PV PRETO / BLACK 2828.870B
<b>Preço / Prix / Precio / Price</b>	€	<b>1.589,00</b>	<b>1.620,00</b>
Dimensões / Dimensions / Dimensiones	mm	595x640x1840	595x640x1840
Volume / Volume / Volume / Volume	lt	300	300
Temperatura / Température / Temperatura / Temperature	°c	-12/-22	-12/-22
Gás refrigerante / Gaz réfrigérant / Gas refrigerante / Refrig, gas		R290	R290
Refrigeração / Refrigeration / Refrigeracion / Cooling	S/V*	S	S
Grelhas / Étagères / Estantes / Shelves	nr	6	6
Peso Bruto / Poids Brut / Peso Bruto / Gross Weight	kg	102	102
Potência / Puissance / Potência / Power	W	620	620
Tensão / Tension / Tension / Tension	V	230	230



MODELO / MODÈLE / MODELO / MODEL CÓDIGO / CODE / CÓDIGO / CODE		UDB 1370 PVD 2828.872
<b>Preço / Prix / Precio / Price</b>	€	<b>1.691,00</b>
Dimensões / Dimensions / Dimensiones	mm	595x640x1965
Volume / Volume / Volume / Volume	lt	300
Temperatura / Température / Temperatura / Temperature	°c	-12/-22
Gás refrigerante / Gaz réfrigérant / Gas refrigerante / Refrig, gas		R290
Refrigeração / Refrigeration / Refrigeracion / Cooling	S/V*	S
Grelhas / Étagères / Estantes / Shelves	nr	6
Peso Bruto / Poids Brut / Peso Bruto / Gross Weight	kg	106
Potência / Puissance / Potência / Power	W	635
Tensão / Tension / Tension / Tension	V	230



MODELO / MODÈLE / MODELO / MODEL CÓDIGO / CODE / CÓDIGO / CODE		UDB 1440 PVD 2828.876
<b>Preço / Prix / Precio / Price</b>	€	<b>2.192,00</b>
Dimensões / Dimensions / Dimensiones	mm	680x655x2090
Volume / Volume / Volume / Volume	lt	480
Temperatura / Température / Temperatura / Temperature	°c	-12/-22
Gás refrigerante / Gaz réfrigérant / Gas refrigerante / Refrig, gas		R290
Refrigeração / Refrigeration / Refrigeracion / Cooling	S/V*	S
Grelhas / Étagères / Estantes / Shelves	nr	6
Peso Bruto / Poids Brut / Peso Bruto / Gross Weight	kg	123
Potência / Puissance / Potência / Power	W	867
Tensão / Tension / Tension / Tension	V	230



\*V = Ventilada / Ventilé / Ventilada / Ventilad | S = Estática / Static / Estática / Static



UDIfri

## ARMÁRIOS VERTICAIS DE CONSERVAÇÃO / CONGELAÇÃO - SUPERMERCADO

ARMOIRES VERTICALES CONSÉRVATION ET CONGÉLATION - SUPERMARCHÉ

ARMARIOS VERTICALES CONSERVACIÓN Y CONGELAMIENTO - SUPERMERCADO

VERTICAL CONSERVATION AND FREEZING COOLERS - SUPERMARKET



Armários de Conservação e congelação  
com 3 portas em vidro  
Luz LED interior  
12 Grelhas Incluídas (4 por porta)



Armoires de conservation et congélation  
avec 3 portes de verre  
Lumière LED intérieur  
12 Grills inclus (4 par port)



Armarios de conservación y  
congelamiento con 3 puertas de vidrio  
Luz LED interior  
12 rejillas incluidas (4 por puerta)



Conservation and freezing cabinets with  
3 glass doors  
interior LED light  
12 Grills Included (4 per door)



MODELO / MODÈLE / MODELO / MODEL CÓDIGO / CODE / CÓDIGO / CODE		UDIFRIACS1600TN 2828.902
<b>Preço / Prix / Precio / Price</b>	€	<b>4.495,00</b>
Dimensões / Dimensions / Dimensiones	mm	1600X760X2030
Volume / Volume / Volume / Volume	Lt	1233 / 1325
Temperatura / Température / Temperatura / Temperature	V	+1/+10
Gás refrigerante / Gaz réfrigérant / Gas refrigerante / Refrig. gas		R290
Refrigeração / Refrigeration / Refrigeracion / Cooling		Mechanical
Grelhas / Étagères / Estantes / Shelves		12
Peso Líquido-Bruto / Poids Net-Brut / Peso Neto-Bruto / Net-Gross Weight	Kg	224 / 229
Potência / Puissance / Potencia / Power	W	1200
Consumo energia/ Consommation d'énergie/ Cons.Energia/Energy Cons.	kWh/24h	8,2
Tensão / Tension / Tensión / Tension	V	230



MODELO / MODÈLE / MODELO / MODEL CÓDIGO / CODE / CÓDIGO / CODE		UDIFRIACS1600BT 2828.904
<b>Preço / Prix / Precio / Price</b>	€	<b>7.249,00</b>
Dimensões / Dimensions / Dimensiones	mm	1600X760X2030
Volume / Volume / Volume / Volume	Lt	1233 / 1325
Temperatura / Température / Temperatura / Temperature	V	-18/-23
Gás refrigerante / Gaz réfrigérant / Gas refrigerante / Refrig. gas		R290
Refrigeração / Refrigeration / Refrigeracion / Cooling		Mechanical
Grelhas / Étagères / Estantes / Shelves		12
Peso Líquido-Bruto / Poids Net-Brut / Peso Neto-Bruto / Net-Gross Weight	Kg	272 / 277
Potência / Puissance / Potencia / Power	W	1250
Consumo energia/ Consommation d'énergie/ Cons.Energia/Energy Cons.	kWh/24h	20,3
Tensão / Tension / Tensión / Tension	V	230



MODELO / MODÈLE / MODELO / MODEL CÓDIGO / CODE / CÓDIGO / CODE		UDIFRIACS1600TN BLACK 2828.901
<b>Preço / Prix / Precio / Price</b>	€	<b>4.495,00</b>
Dimensões / Dimensions / Dimensiones	mm	1600X760X2030
Volume / Volume / Volume / Volume	Lt	1233 / 1325
Temperatura / Température / Temperatura / Temperature	V	+1/+10
Gás refrigerante / Gaz réfrigérant / Gas refrigerante / Refrig. gas		R290
Refrigeração / Refrigeration / Refrigeracion / Cooling		Mechanical
Grelhas / Étagères / Estantes / Shelves		12
Peso Líquido-Bruto / Poids Net-Brut / Peso Neto-Bruto / Net-Gross Weight	Kg	224 / 229
Potência / Puissance / Potencia / Power	W	1200
Consumo energia/ Consommation d'énergie/ Cons.Energia/Energy Cons.	kWh/24h	8,2
Tensão / Tension / Tensión / Tension	V	230



MODELO / MODÈLE / MODELO / MODEL CÓDIGO / CODE / CÓDIGO / CODE		UDIFRIACS1600BT BLACK 2828.903
<b>Preço / Prix / Precio / Price</b>	€	<b>7.249,00</b>
Dimensões / Dimensions / Dimensiones	mm	1600X760X2030
Volume / Volume / Volume / Volume	Lt	1233 / 1325
Temperatura / Température / Temperatura / Temperature	V	-18/-23
Gás refrigerante / Gaz réfrigérant / Gas refrigerante / Refrig. gas		R290
Refrigeração / Refrigeration / Refrigeracion / Cooling		Mechanical
Grelhas / Étagères / Estantes / Shelves		12
Peso Líquido-Bruto / Poids Net-Brut / Peso Neto-Bruto / Net-Gross Weight	Kg	272 / 277
Potência / Puissance / Potencia / Power	W	1250
Consumo energia/ Consommation d'énergie/ Cons.Energia/Energy Cons.	kWh/24h	20,3
Tensão / Tension / Tensión / Tension	V	230

R290 sob pedido / R290 sous demande / R290 a pedido / R290 upon request



**NOVO**  
**NOUVEAU**  
**NUEVO**  
**NEW**



MODELO / MODÈLE / MODELO / MODEL CÓDIGO / CODE / CÓDIGO / CODE		UD-195 PV 2828.970
<b>Preço / Prix / Precio / Price</b>	€	<b>682,00</b>
Dimensões / Dimensions / Dimensiones	mm	485x516x895
Volume / Volume / Volume / Volume	lt	55/85
Temperatura / Température / Temperatura / Temperature	°C	+1/+10
Gás refrigerante / Gaz réfrigérant / Gas refrigerante / Refrig, gas		R600A
Refrigeração / Refrigeration / Refrigeracion / Cooling	S/V*	V*
Grelhas / Étagères / Estantes / Shelves	nr	2
Peso Líquido-Bruto / Poids Net-Brut / Peso Neto-Bruto / Net-Gross Weight	kg	40-50
Potência / Puissance / Potência / Power	W	215
Tensão / Tension / Tension / Tension	V	230

**NOVO**  
**NOUVEAU**  
**NUEVO**  
**NEW**



MODELO / MODÈLE / MODELO / MODEL CÓDIGO / CODE / CÓDIGO / CODE		UD-1500 PVD PIV. 2828.976
<b>Preço / Prix / Precio / Price</b>	€	<b>3.494,00</b>
Dimensões / Dimensions / Dimensiones	mm	1500x712x2044
Volume / Volume / Volume / Volume	lt	1148/1208
Temperatura / Température / Temperatura / Temperature	°C	+1/+10
Gás refrigerante / Gaz réfrigérant / Gas refrigerante / Refrig, gas		R290
Refrigeração / Refrigeration / Refrigeracion / Cooling	S/V*	V*
Grelhas / Étagères / Estantes / Shelves	nr	12
Peso Líquido-Bruto / Poids Net-Brut / Peso Neto-Bruto / Net-Gross Weight	kg	214-223
Potência / Puissance / Potência / Power	W	1200
Tensão / Tension / Tension / Tension	V	230





udifri

**ARMÁRIOS VERTICAIS DE CONSERVAÇÃO COM DISPLAY - GAMA SLIM**  
 ARMOIRES VERTICALES CONSERVATION AVEC AFICHEUR - GAMME SLIM  
 ARMARIOS VERTICALES CONSERVACIÓN CON DISPLAY - GAMA SLIM  
 SLIM GAMMA - VERTICAL CONSERVATION COOLERS WITH DISPLAY



NOVO  
NOUVEAU  
NUEVO  
NEW

SLIM



MODELO / MODÈLE / MODELO / MODEL		UD-1175 PVD
CÓDIGO / CODE / CÓDIGO / CODE		2828.802
<b>Preço / Prix / Precio / Price</b>	<b>€</b>	<b>845,00</b>
Dimensões / Dimensions / Dimensiones	mm	435x460x2013
Volume / Volume / Volume / Volume	lt	145-171
Temperatura / Température / Temperatura / Temperature	°C	+1/+10
Gás refrigerante / Gaz réfrigérant / Gas refrigerante / Refrig, gas		R600A
Grelhas / Étagères / Estantes / Shelves	nr	5
Peso Líquido-Bruto / Poids Net-Brut / Peso Neto-Bruto / Net-Gross Weight	kg	64-70
Potência / Puissance / Potência / Power	W	200
Tensão / Tension / Tension / Tension	V	230

NOVO  
NOUVEAU  
NUEVO  
NEW

SLIM



MODELO / MODÈLE / MODELO / MODEL		UD-1275 PVD
CÓDIGO / CODE / CÓDIGO / CODE		2828.804
<b>Preço / Prix / Precio / Price</b>	<b>€</b>	<b>898,00</b>
Dimensões / Dimensions / Dimensiones	mm	500x640x1980
Volume / Volume / Volume / Volume	lt	238
Temperatura / Température / Temperatura / Temperature	°C	+1/+10
Gás refrigerante / Gaz réfrigérant / Gas refrigerante / Refrig, gas		R600A
Grelhas / Étagères / Estantes / Shelves	nr	5
Peso Líquido-Bruto / Poids Net-Brut / Peso Neto-Bruto / Net-Gross Weight	kg	76-83
Potência / Puissance / Potência / Power	W	270
Tensão / Tension / Tension / Tension	V	230



**NOVO  
NOUVEAU  
NUEVO  
NEW**

## SUB ZERO



MODELO / MODÈLE / MODELO / MODEL	UDICOOOL40G SUB ZERO	
CÓDIGO / CODE / CÓDIGO / CODE	2829.973	
<b>Preço / Prix / Precio / Price</b>	<b>€</b>	<b>1.498,00</b>
Dimensões / Dimensions / Dimensiones	mm	600x624x1850
Dimensões Embalagem / Dimensions Embalage / Dimensiones Embalaje / Packaged Dimensions	mm	660x710x1990
Peso Líquido-Bruto / Poids Net-Brut / Peso Neto-Bruto / Net-Gross Weight	kg	76-80
Volume / Volume / Volume / Volume	lt	400
Temperatura / Température / Temperatura / Temperature	°C	-1/+5
Gás refrigerante / Gaz réfrigérant / Gas refrigerante / Refrig. gas		R600a
Descongelação / Décongélation / Descong. / Defrosting	A/M	N
Refrigeração / Refrigeration / Refrigeracion / Cooling	S/V*	V
Grelhas / Étagères / Estantes / Shelves	nr	4+1
Nível de ruído / Niveau de Bruit / Nivel de Ruído / Noise Level	dB(A)	58
Consumo / Consumption / Consumo / Consommation	kW/24h	1,96
Potência / Puissance / Potencia / Power	W	200
Tensão / Tension / Tensión / Tension	V	230

**NOVO  
NOUVEAU  
NUEVO  
NEW**



MODELO / MODÈLE / MODELO / MODEL	ARM 400 TN PV INOX	
CÓDIGO / CODE / CÓDIGO / CODE	2929.123	
<b>Preço / Prix / Precio / Price</b>	<b>€</b>	<b>1.440,00</b>
Dimensões / Dimensions / Dimensiones	mm	600x723x1890
Dimensões Embalagem / Dimensions Embalage / Dimensiones Embalaje / Packaged Dimensions	mm	632x737x2030
Peso Líquido-Bruto / Poids Net-Brut / Peso Neto-Bruto / Net-Gross Weight	kg	77-86
Volume / Volume / Volume / Volume	lt	400
Temperatura / Température / Temperatura / Temperature	°C	-1/+5
Gás refrigerante / Gaz réfrigérant / Gas refrigerante / Refrig. gas		R600a
Descongelação / Décongélation / Descong. / Defrosting	A/M	N
Refrigeração / Refrigeration / Refrigeracion / Cooling	S/V*	V
Grelhas / Étagères / Estantes / Shelves	nr	4+1
Nível de ruído / Niveau de Bruit / Nivel de Ruído / Noise Level	dB(A)	58
Consumo / Consumption / Consumo / Consommation	kW/24h	1,96
Potência / Puissance / Potencia / Power	W	200
Tensão / Tension / Tensión / Tension	V	230

**NOVO  
NOUVEAU  
NUEVO  
NEW**



MODELO / MODÈLE / MODELO / MODEL	ARM 400 TN INOX	ARM 400 BT INOX	
CÓDIGO / CODE / CÓDIGO / CODE	2929.127	2929.129	
<b>Preço / Prix / Precio / Price</b>	<b>€</b>	<b>1.280,00</b>	<b>1.460,00</b>
Dimensões / Dimensions / Dimensiones	mm	600x685x1890	600x685x1890
Dimensões Embalagem / Dimensions Embalage / Dimensiones Embalaje / Packaged Dimensions	mm	632x737x2030	632x737x2030
Peso Líquido-Bruto / Poids Net-Brut / Peso Neto-Bruto / Net-Gross Weight	kg	62-71	60-70
Volume / Volume / Volume / Volume	lt	400	400
Temperatura / Température / Temperatura / Temperature	°C	+2/+10	-18/-22
Gás refrigerante / Gaz réfrigérant / Gas refrigerante / Refrig. gas		R600a	R290
Descongelação / Décongélation / Descong. / Defrosting	A/M	-	-
Refrigeração / Refrigeration / Refrigeracion / Cooling	S/V*	V	-
Grelhas / Étagères / Estantes / Shelves	nr	4+1	6
Nível de ruído / Niveau de Bruit / Nivel de Ruído / Noise Level	dB(A)	57	57
Consumo / Consumption / Consumo / Consommation	kW/24h	1,709	1,984
Potência / Puissance / Potencia / Power	W	200	400
Tensão / Tension / Tensión / Tension	V	230	230



UDIfri

## ARMÁRIOS VERTICAIS DE CONSERVAÇÃO / CONGELAÇÃO - SNACK

ARMOIRES VERTICALES CONSERVATION / CONGÉLATION - SNACK

ARMARIOS VERTICALES CONSERVACIÓN / CONGELAMIENTO - SNACK

SNACK - VERTICAL CONSERVATION / FREEZING COOLERS



Interior Branco  
Inclui 4 prateleiras + 1 prateleira de fundo.  
Porta reversível  
TN - Modelos de Refrigeração Ventilada  
BT - Modelos de Refrigeração Assistida



Intérieure Blanc  
Comprend 4 étagère + 1 étagère du bas. Porte réversible  
TB - Modèles de Refroidissement Ventilé  
BT - Modèles de Refroidissement Assistée



Interior Blanco  
Incluye 4 estantes + 1 estante inferior. Puerta reversible  
TN - Modelos de Refrigeração Ventilada  
BT - Modelos de Refrigeração Assistida



White Interior  
Includes 4 shelves + 1 bottom shelf. Reversible door  
TN - Ventilated Cooling Models  
BT - Assisted Cooling Models



MODELO / MODÈLE / MODELO / MODEL	UD600TN PORTA VIDRO	
CÓDIGO / CODE / CÓDIGO / CODE	2929.112	
<b>Preço / Prix / Precio / Price</b>	€	<b>2.017,00</b>
Dimensões / Dimensions / Dimensiones	mm	775x735x1870
Volume / Volume / Volume / Volume	lt	600
Temperatura / Température / Temperatura / Temperature	°C	+2/+8
Gás refrigerante / Gaz réfrigérant / Gas refrigerante / Refrig. gas		-
Refrigeração / Refrigeration / Refrigeracion / Cooling	S/V*	-
Grelhas / Étagères / Estantes / Shelves	nr	-
Peso Bruto / Poids Brut / Peso Bruto / Gross Weight	kg	112
Potência / Puissance / Potencia / Power	W	-
Tensão / Tension / Tensión / Tension	V	-



MODELO / MODÈLE / MODELO / MODEL	UD600 TN BRANCO	UD600 BT BRANCO
CÓDIGO / CODE / CÓDIGO / CODE	2929.110	2929.114
<b>Preço / Prix / Precio / Price</b>	€	<b>1.703,00</b>
Dimensões / Dimensions / Dimensiones	mm	775x735x1870
Volume / Volume / Volume / Volume	lt	600
Temperatura / Température / Temperatura / Temperature	°C	+2/+8
Refrigeração / Refrigeration / Refrigeracion / Cooling	S/V*	S
Peso Bruto / Poids Brut / Peso Bruto / Gross Weight	kg	100
Potência / Puissance / Potencia / Power	W	240
Tensão / Tension / Tensión / Tension	V	230



MODELO / MODÈLE / MODELO / MODEL	600 TN V BRANCO PORTA VIDRO	
CÓDIGO / CODE / CÓDIGO / CODE	2929.124	
<b>Preço / Prix / Precio / Price</b>	€	<b>1.580,00</b>
Dimensões / Dimensions / Dimensiones	mm	775x725x1890
Volume / Volume / Volume / Volume	lt	600
Temperatura / Température / Temperatura / Temperature	°C	+2/+8
Gás refrigerante / Gaz réfrigérant / Gas refrigerante / Refrig. gas		R600a
Descongelação / Décongélation / Descong. / Defrosting	A/M	A
Refrigeração / Refrigeration / Refrigeracion / Cooling	S/V*	S
Grelhas / Étagères / Estantes / Shelves	nr	3+1
Peso Bruto / Poids Brut / Peso Bruto / Gross Weight	kg	124
Potência / Puissance / Potencia / Power	W	185
Tensão / Tension / Tensión / Tension	V	230



MODELO / MODÈLE / MODELO / MODEL	600 TN AÇO INOX	600 BT AÇO INOX
CÓDIGO / CODE / CÓDIGO / CODE	2929.128	2929.130
<b>Preço / Prix / Precio / Price</b>	€	<b>1.482,00</b>
Dimensões / Dimensions / Dimensiones	mm	775x716x1860
Volume / Volume / Volume / Volume	lt	600
Temperatura / Température / Temperatura / Temperature	°C	+2/+10
Gás refrigerante / Gaz réfrigérant / Gas refrigerante / Refrig. gas		R600a
Refrigeração / Refrigeration / Refrigeracion / Cooling	S/V*	V
Grelhas / Étagères / Estantes / Shelves	nr	4+1
Peso Líquido-Bruto / Poids Net-Brut / Peso Neto-Bruto / Net-Gross Weight	kg	85-97
Potência / Puissance / Potencia / Power	W	200
Tensão / Tension / Tensión / Tension	V	230



confirmar disponibilidade  
confirmer la disponibilité  
confirmar la disponibilidad  
confirm the availability

\*V = Ventilada / Ventilé / Ventilada / Ventilated | S = Estática / Static / Estática / Static



**NOVO  
NOUVEAU  
NUEVO  
NEW**

**530x560mm**

Dimensão da prateleira

Dimension de l'étagère

Dimensión del estante

Shelf Dimension

MODELO / MODÈLE / MODELO / MODEL		400 TN2	400BT2
CÓDIGO / CODE / CÓDIGO / CODE		2929.050	2929.052
<b>Preço / Prix / Precio / Price</b>	<b>€</b>	<b>1.998,00</b>	<b>2.260,00</b>
Dimensões / Dimensions / Dimensiones	mm	680x730x1975	680x730x1975
Dimensões Embalagem / Dimensions Embalage / Dimensiones Embalaje / Packaged Dimensions	mm	700x745x2105	700x745x2105
Peso Líquido-Bruto / Poids Net-Brut / Peso Neto-Bruto / Net-Gross Weight	kg	93-114	98-115
Volume / Volume / Volume / Volume	lt	450	450
Temperatura / Température / Temperatura / Temperature	°C	-2/+8	-18/-22
Gás refrigerante / Gaz réfrigérant / Gas refrigerante / Refrig. gas		R290	R290
Refrigeração / Refrigeration / Refrigeracion / Cooling	S/V*	V	V
Grelhas / Étagères / Estantes / Shelves	nr	3+1	3+1
Nível de ruído / Niveau de Bruit / Nivel de Ruído / Noise Level	dB(A)	50	50
Consumo / Consumption / Consumo / Consommation	kW/24h	1,76	5,88
Potência / Puissance / Potencia / Power	W	180	345
Tensão / Tension / Tensión / Tension	V	230	230





udi fri

## ARMÁRIOS VERTICAIS DE CONSERVAÇÃO E CONGELAÇÃO GN2/1

ARMOIRES VERTICALES DE CONSERVATION ET CONGÉLATION GN2/1

ARMARIOS VERTICALES CONSERVACIÓN Y CONGELAMIENTO GN2/1

GN2/1 VERTICAL CONSERVATION AND FREEZING COOLERS



Evaporação automática de água durante a descongelação.  
Isolamento de poliuretano Ozone-friendly de 48 mm de espessura.  
Portas de fechamento automático.  
Evaporador de tubo de cobre com aletas de alumínio.  
Estrutura de aço inoxidável.



Evaporation automatique de l'eau pendant le dégivrage.  
Isolation en polyuréthane d'une épaisseur de 48 mm, respectant l'ozone.  
Portes à fermeture automatique.  
Évaporateur à tube de cuivre avec ailettes en aluminium.  
Structure en acier inoxydable.



Evaporación automática del agua durante el desescarche.  
Aislamiento de poliuretano de 48 mm de grosor apto para el ozono.  
Puertas de cierre automático.  
Evaporador de tubo de cobre con aletas de aluminio.  
Estructura de acero inoxidable.



Automatic evaporation of water during defrosting.  
"Ozone-friendly" 48 mm thickness polyurethane isolation.  
Self closing doors.  
Copper tube evaporator with aluminum fins.  
Stainless steel structure.



MODELO / MODÈLE / MODELO / MODEL	U700TN1 GN2/1	
CÓDIGO / CODE / CÓDIGO / CODE	5200.200	
<b>Preço / Prix / Precio / Price</b>	<b>€</b>	<b>1.998,00</b>
Dimensões / Dimensions / Dimensiones	mm	700x800x2050
Volume / Volume / Volume / Volume	lt	700
Temperatura / Température / Temperatura / Temperature	°C	0/+5
Gás refrigerante / Gaz réfrigérant / Gas refrigerante / Refrig. gas		R290
Descongelação / Décongélation / Descong. / Defrosting	A/M	A
Refrigeração / Refrigeration / Refrigeracion / Cooling	S/V*	V
Grelhas / Étagères / Estantes / Shelves	nr	3
Peso Bruto / Poids Brut / Peso Bruto / Gross Weight	kg	130
Potência / Puissance / Potencia / Power	kW	0,4
Tensão / Tension / Tensión / Tension	V	230



MODELO / MODÈLE / MODELO / MODEL	U1400BT2 GN2/1	
CÓDIGO / CODE / CÓDIGO / CODE	5200.204	
<b>Preço / Prix / Precio / Price</b>	<b>€</b>	<b>3.959,00</b>
Dimensões / Dimensions / Dimensiones	mm	1400x800x2050
Volume / Volume / Volume / Volume	lt	1400
Temperatura / Température / Temperatura / Temperature	°C	-18/-20
Gás refrigerante / Gaz réfrigérant / Gas refrigerante / Refrig. gas		R290
Descongelação / Décongélation / Descong. / Defrosting	A/M	A
Refrigeração / Refrigeration / Refrigeracion / Cooling	S/V*	V
Grelhas / Étagères / Estantes / Shelves	nr	6
Peso Bruto / Poids Brut / Peso Bruto / Gross Weight	kg	245
Potência / Puissance / Potencia / Power	kW	1,3
Tensão / Tension / Tensión / Tension	V	230



MODELO / MODÈLE / MODELO / MODEL		700 TN1 PV GN2/1	700 BT1 PV GN2/1
CÓDIGO / CODE / CÓDIGO / CODE		2929.030	2929.032
<b>Preço / Prix / Precio / Price</b>	<b>€</b>	<b>2.411,00</b>	<b>2.998,00</b>
Dimensões / Dimensions / Dimensiones	mm	700x820x2050	700x820x2050
Volume / Volume / Volume / Volume	lt	550	550
Temperatura / Température / Temperatura / Temperature	°C	+2/+8	-18/-22
Gás refrigerante / Gaz réfrigérant / Gas refrigerante / Refrig. Gas		R290	R290
Peso Líquido / Poids Net / Peso Neto / Net Weight	kg	122	137
Consumo / Consumption / Consumo / Consommation	kW/24h	3,2	9
Tensão / Tension / Tensión / Tension	V	230	230



MODELO / MODÈLE / MODELO / MODEL		1400 TN2 PV GN2/1
CÓDIGO / CODE / CÓDIGO / CODE		2929.042
<b>Preço / Prix / Precio / Price</b>	<b>€</b>	<b>3.984,00</b>
Dimensões / Dimensions / Dimensiones	mm	1400x820x 2050
Volume / Volume / Volume / Volume	lt	1300
Temperatura / Température / Temperatura / Temperature	°C	+2/+8
Gás refrigerante / Gaz réfrigérant / Gas refrigerante / Refrig. Gas		R290
Peso Líquido / Poids Net / Peso Neto / Net Weight	kg	183
Consumo / Consumption / Consumo / Consommation	kW/24h	5,4
Tensão / Tension / Tensión / Tension	V	230

Inclui 3 prateleiras + 3 pares de guias por porta + porta reversível / Comprend 3 étagère + 3 guides par porte + porte réversible  
 Incluye 3 estantes + 3 guias por puerta + puerta reversible / Includes 3 shelves + 3 guides by door + reversible door.



UDIfri

## ARMÁRIOS VERTICAIS DE CONSERVAÇÃO / CONGELAÇÃO GN2/1

ARMOIRES VERTICALES CONSERVATION / CONGÉLATION GN2/1

ARMARIOS VERTICALES CONSERVACIÓN / CONGELAMIENTO GN2/1

GN2/1 VERTICAL CONSERVATION / FREEZING COOLERS



Os armários são em aço inoxidável AISI 304, todas as estruturas, incluindo as salas dos motores, são espumadas e têm ângulos internos, de arredondamento para facilitar a limpeza. As portas estão equipadas com alças laterais, bem como juntas magnéticas de quatro lados para garantir uma vedação perfeita. A refrigeração ventilada garante uma excelente distribuição de ar frio em cada parte do armário. A temperatura é exibida de forma clara e constante e pode ser ajustada por meio de botões no termostato eletrónico. Uma luz indicadora acende quando a máquina está descongelando automaticamente.



Les armoires sont en acier inoxydable AISI 304, toutes les structures, y compris les salles des machines, sont moussées et ont des angles intérieurs et arrondis pour un nettoyage facile. Les portes sont équipées de poignées latérales ainsi que de joints magnétiques à quatre faces pour assurer un joint d'étanchéité parfait. La réfrigération ventilée garantit une excellente répartition de l'air froid dans chaque partie de l'armoire. La température est clairement et constamment affichée et peut être réglée au moyen de boutons-poussoirs sur le thermostat électronique. Un voyant s'allume lorsque la machine se dégrade automatiquement.



Los gabinetes son de acero inoxidable AISI 304, todas las estructuras, incluidas las salas de máquinas, están espumadas y tienen ángulos internos de fondo redondeado para una fácil limpieza. Las puertas están equipadas con manijas laterales largas así como juntas magnéticas de cuatro lados para asegurar un sellado perfecto. La refrigeración ventilada garantiza una excelente distribución del aire frío en cada parte del armario. La temperatura se visualiza de forma clara y constante y se puede ajustar con los pulsadores del termostato electrónico. Una luz indicadora se enciende cuando la máquina está descongelando automáticamente.



Cabinets are AISI 304 stainless steel, all structures, including the engine rooms, are foamed and have internal, rounded - bottom angles for easy cleaning. The doors are equipped with side-long handles as well as four-sided magnetic gaskets to ensure a perfect seal. Ventilated refrigeration guarantees an excellent distribution of cold air in every part of the cabinet. The temperature is clearly and constantly displayed and can be set by means of push buttons on the electronic thermostat. An indicating light turns on when the machine is defrosting automatically.



MODELO / MODÈLE / MODELO / MODEL		700 TN1 GN2/1	700 BT1 GN2/1
CÓDIGO / CODE / CÓDIGO / CODE		2929.022	2929.024
Preço / Prix / Precio / Price	€	2.074,00	2.640,00
Dimensões / Dimensions / Dimensiones	mm	700x823x2045	700x823x2045
Volume / Volume / Volume / Volume	lt	546	546
Temperatura / Température / Temperatura / Temperature	°C	-2/+8	-18/-22
Gás refrigerante / Gaz réfrigérant / Gas refrigerante / Refrig. Gas		R290	R290
Peso Líquido-Bruto / Poids Net-Brut/ Peso Neto-Bruto / Net-Gross Weight	kg	108-121	108-121
Consumo / Consumption / Consumo / Consommation	kW/24h	1,7	6,32
Potência / Puissance / Potencia / Power	kW	0,210	0,313
Tensão / Tension / Tensión / Tension	V	230	230



MODELO / MODÈLE / MODELO / MODEL		1400 TN2 GN2/1	1400 BT2 GN2/1
CÓDIGO / CODE / CÓDIGO / CODE		2929.034	2929.036
Preço / Prix / Precio / Price	€	2.995,00	4.270,00
Dimensões / Dimensions / Dimensiones	mm	1400x823x2045	1400x823x2045
Volume / Volume / Volume / Volume	lt	1255	1105
Temperatura / Température / Temperatura / Temperature	°C	-2/+8	-18/-22
Gás refrigerante / Gaz réfrigérant / Gas refrigerante / Refrig. Gas		R290	R290
Peso Líquido-Bruto / Poids Net-Brut/ Peso Neto-Bruto / Net-Gross Weight	kg	165-187	165-187
Consumo / Consumption / Consumo / Consommation	kW/24h	2,57	11,5
Potência / Puissance / Potencia / Power	kW	0,286	0,733
Tensão / Tension / Tensión / Tension	V	230	230

**Inclui 3 prateleiras + 3 pares de guias por porta + porta reversível**  
 Comprend 3 étagère + 3 guides par porte + porte réversible  
 Incluye 3 estantes + 3 guías por puerta + puerta reversible  
 Includes 3 shelves + 3 guides by door + reversible door

**650x530x1400**  
 Dimensões Internas  
 Dimensions Internes  
 Dimensiones Internas  
 Internal Dimensions



opcional  
 optionnel  
 optional



**PRATELEIRA / SHELF**

2929.152

54,00



opcional  
 optionnel  
 optional

**CONJUNTO DE GUIAS / GUIDES KIT**

2929.154

54,00



MODELO / MODÈLE / MODELO / MODEL		1400TN2 GN2/1
CÓDIGO / CODE / CÓDIGO / CODE		5400.034
Preço / Prix / Precio / Price	€	3.321,00
Dimensões / Dimensions / Dimensiones	mm	1400x870x2100
Volume / Volume / Volume / Volume	lt	1340
Temperatura / Température / Temperatura / Temperature	°C	-2/+8
Gás refrigerante / Gaz réfrigérant / Gas refrigerante / Refrig. Gas		R290
Peso Líquido / Poids Net / Peso Neto / Net Weight	kg	190
Potência / Puissance / Potencia / Power	kW	0,651
Tensão / Tension / Tensión / Tension	V	230

**MADE IN ITALY**
**NOVO  
NOUVEAU  
NUEVO  
NEW**

MODELO / MODÈLE / MODELO / MODEL	OPTIMUM 700TN GN2/1 PV	
CÓDIGO / CODE / CÓDIGO / CODE	2930.030	
<b>Preço / Prix / Precio / Price</b>	<b>€</b>	<b>2.442,00</b>
Dimensões / Dimensions / Dimensiones	mm	710x800x2035
Dimensões Embalagem / Dimensions Embalage / Dimensiones Embalaje / Packaged Dimensions	mm	760x855x2090
Volume / Volume / Volume / Volume	lt	590
Temperatura / Température / Temperatura / Temperature	°C	0/+10
Classe Energética / Classe Énergétique / Clase Energética Climate Class		5
Gás refrigerante / Gaz réfrigérant / Gas refrigerante / Refrig. gas		R452a
Nível de ruído / Niveau de Bruit / Nivel de Ruído / Noise Level	dB(A)	42
Descongelação / Décongélation / Descong. / Defrosting	A/M	A
Refrigeração / Refrigeration / Refrigeracion / Cooling	S/V*	V
Consumo / Consumption / Consumo / Consommation	kW/24h	2,3
Grelhas / Étagères / Estantes / Shelves	nr	3
Peso Líquido-Bruto / Poids Net-Brut / Peso Neto-Bruto / Net-Gross Weight	kg	96-104
Potência / Puissance / Potencia / Power	W	380
Tensão / Tension / Tensión / Tension	V	230

**NOVO  
NOUVEAU  
NUEVO  
NEW**

MODELO / MODÈLE / MODELO / MODEL	OPTIMUM 700TN GN2/1	OPTIMUM 700BT GN2/1	
CÓDIGO / CODE / CÓDIGO / CODE	2930.022	2930.024	
<b>Preço / Prix / Precio / Price</b>	<b>€</b>	<b>2.085,00</b>	<b>2.631,00</b>
Dimensões / Dimensions / Dimensiones	mm	710x800x2035	710x800x2035
Dimensões Embalagem / Dimensions Embalage / Dimensiones Embalaje / Packaged Dimensions	mm	760x855x2090	760x855x2090
Volume / Volume / Volume / Volume	lt	590	590
Temperatura / Température / Temperatura / Temperature	°C	0/+10	-18/-22
Classe Energética / Classe Énergétique / Clase Energética Climate Class		5	5
Gás refrigerante / Gaz réfrigérant / Gas refrigerante / Refrig. gas		R452a	R452a
Nível de ruído / Niveau de Bruit / Nivel de Ruído / Noise Level	dB(A)	42	45
Descongelação / Décongélation / Descong. / Defrosting	A/M	A	A
Refrigeração / Refrigeration / Refrigeracion / Cooling	S/V*	V	V
Consumo / Consumption / Consumo / Consommation	kW/24h	5,4	7,1
Grelhas / Étagères / Estantes / Shelves	nr	3	3
Peso Líquido-Bruto / Poids Net-Brut / Peso Neto-Bruto / Net-Gross Weight	kg	96-104	96-104
Potência / Puissance / Potencia / Power	W	380	557
Tensão / Tension / Tensión / Tension	V	230	230

**OPCIONAIS / OPTIONNELLES / OPCIONALES / OPTIONALS**

COD.	MODELO / MODÈLE / MODELO / MODEL	€
2930.032	KIT PORTA REVERSIVEL ARMARIO 700	43,00
2930.034	KIT SUPORTES ARMARIO 700L	57,00
2930.036	GRELHA PLASTICA CINZA ARMARIO 700L	43,00

**NOVO  
NOUVEAU  
NUEVO  
NEW**

MODELO / MODÈLE / MODELO / MODEL	OPTIMUM 1400TN GN2/1	OPTIMUM 1400BT GN2/1	
CÓDIGO / CODE / CÓDIGO / CODE	2930.023	2930.026	
<b>Preço / Prix / Precio / Price</b>	<b>€</b>	<b>3.098,00</b>	<b>3.596,00</b>
Dimensões / Dimensions / Dimensiones	mm	1420x800x2030/2100	1420x800x2030/2100
Dimensões Embalagem / Dimensions Embalage / Dimensiones Embalaje / Packaged Dimensions	mm	1460x840x2200	1460x840x2200
Volume / Volume / Volume / Volume	lt	909	909
Temperatura / Température / Temperatura / Temperature	°C	0/+10	-18/-22
Classe Energética / Classe Énergétique / Clase Energética Climate Class		5	5
Gás refrigerante / Gaz réfrigérant / Gas refrigerante / Refrig. gas		R452a	R452a
Nível de ruído / Niveau de Bruit / Nivel de Ruído / Noise Level	dB(A)	42	45
Descongelação / Décongélation / Descong. / Defrosting	A/M	A	A
Refrigeração / Refrigeration / Refrigeracion / Cooling	S/V*	V	V
Consumo / Consumption / Consumo / Consommation	kW/24h	4,2	14,6
Grelhas / Étagères / Estantes / Shelves	nr	6	6
Peso Bruto / Poids Brut / Peso Bruto / Gross Weight	kg	150-165	165-180
Potência / Puissance / Potencia / Power	W	440	760
Tensão / Tension / Tensión / Tension	V	230	230

\*V = Ventilada / Ventilé / Ventilada / Ventiladed | S = Estática / Static / Estática / Static



udi fri

## ARMÁRIOS VERTICAIS DE CONSERVAÇÃO E CONGELAÇÃO GN2/1

ARMOIRES VERTICALES DE CONSERVATION ET CONGÉLATION GN2/1

ARMARIOS VERTICALES CONSERVACIÓN Y CONGELAMIENTO GN2/1

GN2/1 VERTICAL CONSERVATION AND FREEZING COOLERS



MODELO / MODÈLE / MODELO / MODEL	1400TN2 GN2/1	
CÓDIGO / CODE / CÓDIGO / CODE	3500.514	
<b>Preço / Prix / Precio / Price</b>	<b>€</b>	<b>3.276,00</b>
Dimensões / Dimensions / Dimensiones	mm	1480x830x2010
Volume / Volume / Volume / Volume	lt	1325
Temperatura / Température / Temperatura / Temperature	°C	-2/+8
Gás refrigerante / Gaz réfrigérant / Gas refrigerante / Refrig. gas		R290
Descongelação / Décongélation / Descong. / Defrosting	A/M	-
Refrigeração / Refrigeration / Refrigeracion / Cooling	S/V*	V
Grelhas / Étagères / Estantes / Shelves	nr	6
Peso Bruto / Poids Brut / Peso Bruto / Gross Weight	kg	219
Potência / Puissance / Potencia / Power	W	320
Tensão / Tension / Tensión / Tension	V	230



MODELO / MODÈLE / MODELO / MODEL	1400BT2 GN2/1	
CÓDIGO / CODE / CÓDIGO / CODE	3500.516	
<b>Preço / Prix / Precio / Price</b>	<b>€</b>	<b>4.298,00</b>
Dimensões / Dimensions / Dimensiones	mm	1480x830x2010
Volume / Volume / Volume / Volume	lt	1325
Temperatura / Température / Temperatura / Temperature	°C	-18/-22
Gás refrigerante / Gaz réfrigérant / Gas refrigerante / Refrig. gas		R290
Descongelação / Décongélation / Descong. / Defrosting	A/M	-
Refrigeração / Refrigeration / Refrigeracion / Cooling	S/V*	V
Grelhas / Étagères / Estantes / Shelves	nr	6
Peso Bruto / Poids Brut / Peso Bruto / Gross Weight	kg	235
Potência / Puissance / Potencia / Power	W	730
Tensão / Tension / Tensión / Tension	V	230

\*V = Ventilada / Ventilé / Ventilada / Ventilated | S = Estática / Static / Estática / Static



**NOVO  
NOUVEAU  
NUEVO  
NEW**



MODELO / MODÈLE / MODELO / MODEL		AC7RP 700TN1	AC7RF 700BT1
CÓDIGO / CODE / CÓDIGO / CODE		2929.021	2929.027
<b>Preço / Prix / Precio / Price</b>	<b>€</b>	<b>1.990,00</b>	<b>2.484,00</b>
Dimensões / Dimensions / Dimensiones	mm	700x880x2043	700x880x2043
Dimensões Embalagem / Dimensions Embalage / Dimensiones Embalaje / Packaged Dimensions	mm	740x900x2143	740x900x2143
Volume / Volume / Volume / Volume	lt	580	580
Temperatura / Température / Temperatura / Temperature	°C	0/+8	-18/-22
Gás refrigerante / Gaz réfrigérant / Gas refrigerante / Refrig. gas		R290	R290
Nível de ruído / Niveau de Bruit / Nivel de Ruído / Noise Level	dB(A)	49	52
Consumo / Consumption / Consumo / Consommation	kW/24h	1,81	6,42
Peso Líquido-Bruto / Poids Net-Brut / Peso Neto-Bruto / Net-Gross Weight	kg	112/122	119/129
Potência / Puissance / Potencia / Power	W	250	522
Tensão / Tension / Tensión / Tension	V	230	230

**NOVO  
NOUVEAU  
NUEVO  
NEW**



MODELO / MODÈLE / MODELO / MODEL		AC14RP 1400TN2	AC14RF 1400BT2
CÓDIGO / CODE / CÓDIGO / CODE		2929.033	2929.037
<b>Preço / Prix / Precio / Price</b>	<b>€</b>	<b>2.840,00</b>	<b>3.980,00</b>
Dimensões / Dimensions / Dimensiones	mm	1400x880x2043	1400x880x2043
Dimensões Embalagem / Dimensions Embalage / Dimensiones Embalaje / Packaged Dimensions	mm	1440x900x2143	1440x900x2143
Volume / Volume / Volume / Volume	lt	1400	1400
Temperatura / Température / Temperatura / Temperature	°C	0/+8	-18/-22
Gás refrigerante / Gaz réfrigérant / Gas refrigerante / Refrig. gas		R290	R290
Nível de ruído / Niveau de Bruit / Nivel de Ruído / Noise Level	dB(A)	50	53
Consumo / Consumption / Consumo / Consommation	kW/24h	2,5	11,2
Peso Líquido-Bruto / Poids Net-Brut / Peso Neto-Bruto / Net-Gross Weight	kg	190/204	200/214
Potência / Puissance / Potencia / Power	W	600	950
Tensão / Tension / Tensión / Tension	V	230	230



udi fri



Armários de conservação ou congelação ventilado com interior e exterior em aço inoxidável AISI 201. Espessura do isolamento de 60 mm. Painel com termostato eletrónico. Portas de fecho automático com junta magnética. Iluminação interna LED. Porta reversível. Funcionamento com temperatura ambiente até +38°C. Descongelação automática com resistência. Pés ajustáveis em altura.



Armoires de conservation ou de congélation ventilée avec intérieur et extérieur en acier inoxydable AISI 201. Épaisseur de l'isolation de 60 mm. Panneau avec thermostat électronique. Portes à fermeture automatique avec joint magnétique. Éclairage LED intérieur. Porte réversible. Fonctionnement à température ambiante jusqu'à +38°C. Décongélation automatique avec résistance. Pieds réglables en hauteur.



Armarios de conservación o congelación ventilado con interior y exterior de acero inoxidable AISI 201. Espesor del aislamiento de 60 mm. Panel con termostato electrónico. Puertas de cierre automático con junta magnética. Iluminación LED interior. Puerta reversible. Funcionamiento a temperatura ambiente hasta +38°C. Descongelación automática con resistencia. Pies ajustables en altura.



Ventilated preservation or freezing cabinets with AISI 201 stainless steel interior and exterior. 60mm insulation thickness. Panel with electronic thermostat. Self-closing doors with magnetic seal. LED interior lighting. Reversible door. Operating at ambient temperature up to +38°C. Automatic defrost with resistance. Height-adjustable feet.



NOVO  
NOUVEAU  
NUEVO  
NEW



MODELO / MODÈLE / MODELO / MODEL	UDAX700 TN	
CÓDIGO / CODE / CÓDIGO / CODE	2829.969	
<b>Preço / Prix / Precio / Price</b>	€	<b>2.048,00</b>
Dimensões / Dimensions / Dimensiones	mm	740x830x2010
Volume Líquido-Bruto / Volume Net-Brut / Volumen Neto-Bruto / Net-Gross Volume	lt	503-700
Temperatura / Température / Temperatura / Temperature	°C	-2/+8
Gás refrigerante / Gaz réfrigérant / Gas refrigerante / Refrig. Gas		R290
Grelhas / Étagères / Estantes / Shelves	nr	3 (530x645)
Peso Líquido-Bruto / Poids Net-Brut/ Peso Neto-Bruto / Net-Gross Weight	kg	113-123
Consumo / Consumption / Consumo / Consommation	kW/24h	2,42
Potência / Puissance / Potencia / Power	kW	0,27
Tensão / Tension / Tensión / Tension	V	230

NOVO  
NOUVEAU  
NUEVO  
NEW



MODELO / MODÈLE / MODELO / MODEL	UDAX700 BT	
CÓDIGO / CODE / CÓDIGO / CODE	2829.972	
<b>Preço / Prix / Precio / Price</b>	€	<b>2.580,00</b>
Dimensões / Dimensions / Dimensiones	mm	740x830x2010
Volume / Volume / Volume / Volume	lt	503-700
Temperatura / Température / Temperatura / Temperature	°C	-22/-18
Gás refrigerante / Gaz réfrigérant / Gas refrigerante / Refrig. Gas		R290
Grelhas / Étagères / Estantes / Shelves	nr	3 (530x645)
Peso Líquido-Bruto / Poids Net-Brut/ Peso Neto-Bruto / Net-Gross Weight	kg	131-141
Consumo / Consumption / Consumo / Consommation	kW/24h	9,4
Potência / Puissance / Potencia / Power	kW	0,5
Tensão / Tension / Tensión / Tension	V	230



**NOVO  
NOUVEAU  
NUEVO  
NEW**



MODELO / MODÈLE / MODELO / MODEL		ARPA460TN (60X40)	ARPA460BT (60X40)
CÓDIGO / CODE / CÓDIGO / CODE		2929.131	2929.133
<b>Preço / Prix / Precio / Price</b>	<b>€</b>	<b>1.542,00</b>	<b>1.739,00</b>
Dimensões / Dimensions / Dimensiones	mm	740x680x1800	740x680x1800
Dimensões Embalagem / Dimensions Embalage / Dimensiones Embalaje / Packaged Dimensions	mm	765x665x1950	765x665x1950
Peso Líquido-Bruto / Poids Net-Brut / Peso Neto-Bruto / Net-Gross Weight	kg	88-114	86-112
Volume / Volume / Volume / Volume	lt	400	400
Temperatura / Température / Temperatura / Temperature	°C	+2/+8	-18/-22
Refrigeração / Refrigeration / Refrigeración / Cooling	S/V*	S	S
Descongelação / Décongélation / Descong. / Defrosting	A/M	A	M
Gás refrigerante / Gaz réfrigérant / Gas refrigerante / Refrig. gas		R600a	R290
Prateleiras / Étagères / Estantes / Shelves	nr (60x40)	4+1	
Nível de ruído / Niveau de Bruit / Nivel de Ruído / Noise Level	dB(A)	49	61
Consumo / Consumption / Consumo / Consommation	kw/24h	0,99	3,5
Potência / Puissance / Potencia / Power	W	180	220
Tensão / Tension / Tensión / Tension	V	230	230

\*V = Ventilada / Ventilé / Ventilada / Ventilated | S = Estática / Static / Estática / Static





udi fri

**ARMÁRIOS VERTICAIS CONSERVAÇÃO E CONGELAÇÃO | PADARIA | PASTELARIA**

ARMOIRES VERTICALES CONSERVATION ET CONGÉLATION - BOULANGERIE | PÂTISSERIE

ARMARIOS VERTICALES DE CONSERVACIÓN Y CONGELAMIENTO - PANADERÍA | PASTELERÍA

CONSERVATION VERTICAL FRESH AND FREEZING COOLERS - BAKERY | PASTRY



MODELO / MODÈLE / MODELO / MODEL		ARM CV 620 45X75	ARM CV 620 40X60
CÓDIGO / CODE / CÓDIGO / CODE		2828.571	2828.572
<b>Preço / Prix / Precio / Price</b>	<b>€</b>	<b>2.269,00</b>	<b>2.269,00</b>
Dimensões / Dimensions / Dimensiones	mm	600x920x1600	600x920x1600
Descongelação / Décongélation / Descongelación / Defrosting	M/A	M	M
Refrigeração Estática / Réfrigération statique / Refrigeración estática / Static cooling		√	√
Temperatura / Température / Temperatura / Temperature	°C	-18 / -22	-18 / -22
Volume / Volume / Volume / Volume	Lt	620	620
Nº Prateleiras / Nº Étagères / Nº Estantes / Shelves No.	Nº	28	28
Gás refrigerante / Gaz réfrigérant / Gas refrigerante / Refrigerant gas		R134A	R134A
Peso Líquido-Bruto / Poids Net-Brut / Peso Neto-Bruto / Net-Gross Weight	kg	85	85
Potência / Puissance / Potencia / Power	kW	0,24	0,24
Tensão / Tension / Tensión / Tension	V	230	230



MODELO / MODÈLE / MODELO / MODEL		ARV 620 45X75	ARV 620 40X60
CÓDIGO / CODE / CÓDIGO / CODE		2828.573	2828.574
<b>Preço / Prix / Precio / Price</b>	<b>€</b>	<b>2.332,00</b>	<b>2.332,00</b>
Dimensões / Dimensions / Dimensiones	mm	600x920x1600	600x920x1600
Descongelação / Décongélation / Descongelación / Defrosting	M/A	M	M
Refrigeração Estática / Réfrigération statique / Refrigeración estática / Static cooling		√	√
Temperatura / Température / Temperatura / Temperature	°C	+4 / +8	+4 / +8
Volume / Volume / Volume / Volume	Lt	620	620
Nº Prateleiras / Nº Étagères / Nº Estantes / Shelves No.	Nº	28	28
Gás refrigerante / Gaz réfrigérant / Gas refrigerante / Refrigerant gas		R134A	R134A
Peso Líquido-Bruto / Poids Net-Brut / Peso Neto-Bruto / Net-Gross Weight	kg	85	85
Potência / Puissance / Potencia / Power	kW	0,24	0,24
Tensão / Tension / Tensión / Tension	V	230	230



MODELO / MODÈLE / MODELO / MODEL		ARM ARV 620 60X40 INOX
CÓDIGO / CODE / CÓDIGO / CODE		2828.574A
<b>Preço / Prix / Precio / Price</b>	<b>€</b>	<b>2.633,00</b>
Dimensões / Dimensions / Dimensiones	mm	600x920x1600
Descongelação / Décongélation / Descongelación / Defrosting	M/A	M
Refrigeração Estática / Réfrigération statique / Refrigeración estática / Static cooling		√
Temperatura / Température / Temperatura / Temperature	°C	+4 / +8
Volume / Volume / Volume / Volume	Lt	620
Nº Prateleiras / Nº Étagères / Nº Estantes / Shelves No.	Nº	28
Gás refrigerante / Gaz réfrigérant / Gas refrigerante / Refrigerant gas		R134A
Peso Líquido-Bruto / Poids Net-Brut / Peso Neto-Bruto / Net-Gross Weight	kg	85
Potência / Puissance / Potencia / Power	kW	0,24
Tensão / Tension / Tensión / Tension	V	230



Inclui 10 pares de guias Euronorm standard (capacidade 2 tabuleiros 400x600 por guia)  
 Comprend 10 paires de guides Euronorm standard (capacité 2 plateaux 400x600 par guide)  
 Incluye 10 pares de guias Euronorm estándar (capacidad 2 bandejas 400x600 por guía)  
 Includes 10 Euronorm pairs of standard guides (capacity 2 trays 400x600 per guide)



Dimensões Internas  
 Dimensions Internes  
 Dimensiones Internas  
 Internal Dimensions  
**600x800x1400**

MODELO / MODÈLE / MODELO / MODEL		ARPA 800 TN (60X40)	ARPA 800 BT (60X40)
CÓDIGO / CODE / CÓDIGO / CODE		2929.132	2929.134
<b>Preço / Prix / Precio / Price</b>	<b>€</b>	<b>2.910,00</b>	<b>3.190,00</b>
Dimensões / Dimensions / Dimensiones	mm	740x990x2010	740x990x2010
Descongelação / Décongélation / Descongelación / Defrosting	M/A	A	A
Refrigeração Estática / Réfrigération statique / Refrigeración estática / Static cooling		-	-
Refrigeração Ventilada / Réf. ventilé / Ref. ventilada / Ventilated cooling		✓	✓
Temperatura / Température / Temperatura / Temperature	°C	-2 / +8	-18 / -22
Volume / Volume / Volume / Volume	Lt	737	737
Nº Prateleiras / N° Étagères / N° Estantes / Shelves No.	Nº	20	20
Gás refrigerante / Gaz réfrigérant / Gas refrigerante / Refrigerant gas		R134A	R404A
Peso Líquido-Bruto / Poids Net-Brut / Peso Neto-Bruto / Net-Gross Weight	kg	140	143
Potência / Puissance / Potencia / Power	kW	0,23	0,5
Tensão / Tension / Tensión / Tension	V	230	230



udi fri

## BANCADAS SNACK 600 CONSERVAÇÃO E CONGELAÇÃO

TABLES SNACK 600 CONSERVATION ET CONGELATION

MESAS SNACK 600 CONSERVACIÓN Y CONGELAMIENTO

600 SNACK TABLES CONSERVATION AND FREEZING



Evaporação automática de água durante a descongelação.  
Isolamento de poliuretano Ozon-friendly de 48 mm de espessura.  
Portas de fechamento automático.  
Bordas arredondadas da parte superior da frente.  
Evaporador de tubo de cobre com aletas de alumínio.  
Caixa de prateleira de aço inoxidável ajustável, prateleiras revestidas de plástico.  
Estrutura de aço inoxidável.



Evaporation automatique de l'eau pendant le dégivrage.  
Isolation en polyuréthane d'une épaisseur de 48 mm, respectant l'ozone.  
Portes à fermeture automatique.  
Bords supérieurs arrondis.  
Évaporateur à tube de cuivre avec ailettes en aluminium.  
Boîtier d'étagère réglable en acier inoxydable, étagères revêtues de plastique.  
Structure en acier inoxydable.



Evaporación automática del agua durante el desescarche.  
Aislamiento de poliuretano de 48 mm de grosor apto para el ozono.  
Puertas de cierre automático.  
Bordes superiores delanteros redondeados.  
Evaporador de tubo de cobre con aletas de aluminio.  
Carcasa de estante de acero inoxidable ajustable, estantes recubiertos de plástico.  
Estructura de acero inoxidable.



Automatic evaporation of water during defrosting.  
"Ozone-friendly" 48 mm thickness polyurethane isolation.  
Self closing doors.  
Rounded front top edges.  
Copper tube evaporator with aluminum fins.  
Adjustable, stainless steel shelf housing, plastic coated shelves.  
Stainless steel structure.



MODELO / MODÈLE / MODELO / MODEL	UEP2000 TN-3 PORTAS	
CÓDIGO / CODE / CÓDIGO / CODE	5200.221A	
<b>Preço / Prix / Precio / Price</b>	<b>€</b>	<b>2.486,00</b>
Dimensões / Dimensions / Dimensiones	mm	2000x600x850
Dimensões prateleira / Dimensions étagère / Dimensiones estante / Shelf dimensions	mm	485x415
Volume / Volume / Volume / Volume	lt	400
Temperatura / Température / Temperatura / Temperature	°C	0/+5
Gás refrigerante / Gaz réfrigérant / Gas refrigerante / Refrig. Gas		R290
Peso Bruto / Poids Brut / Peso Bruto / Gross Weight	kg	110
Potência / Puissance / Potencia / Power	kW	0,35
Tensão / Tension / Tensión / Tension	V	230



opcional  
optionnel  
opcional  
optional

PRATELEIRA / SHELF  
UDIEMPY1506001028

22,00



5400.500

 NOVO  
 NOUVEAU  
 NUEVO  
 NEW

5400.508

 NOVO  
 NOUVEAU  
 NUEVO  
 NEW

MODELO / MODÈLE / MODELO / MODEL		MRV140TN 2 PORTAS	MRV140TN 2 PORTAS VIDRO
CÓDIGO / CODE / CÓDIGO / CODE		5400.500	5400.508
<b>Preço / Prix / Precio / Price</b>	€	<b>2.168,00</b>	<b>2.540,00</b>
Dimensões / Dimensions / Dimensiones	mm	1500x600x850	1500x600x850
Volume / Volume / Volume / Volume	lt	275	275
Temperatura / Température / Temperatura / Temperature	°C	+2/+8	-2/+8
Gás refrigerante / Gaz réfrigérant / Gas refrigerante / Refrig. Gas		R290	R290
Peso Líquido-Bruto/Poids Net-Brut/Peso Neto-Bruto/Net-Gross Weight	kg	100-115	115-130
Potência / Puissance / Potencia / Power	W	377	377
Tensão / Tension / Tensión / Tension	V	230	230

5400.512

 NOVO  
 NOUVEAU  
 NUEVO  
 NEW

5400.520

 NOVO  
 NOUVEAU  
 NUEVO  
 NEW

MODELO / MODÈLE / MODELO / MODEL		MRV180TN 3 PORTAS	MRV180TN 3P VIDRO
CÓDIGO / CODE / CÓDIGO / CODE		5400.512	5400.520
<b>Preço / Prix / Precio / Price</b>	€	<b>2.485,00</b>	<b>3.082,00</b>
Dimensões / Dimensions / Dimensiones	mm	2000x600x850	2000x600x850
Volume / Volume / Volume / Volume	lt	440	440
Temperatura / Température / Temperatura / Temperature	°C	+2/+8	-2/+8
Gás refrigerante / Gaz réfrigérant / Gas refrigerante / Refrig. Gas		R290	R290
Peso Líquido-Bruto/Poids Net-Brut/Peso Neto-Bruto/Net-Gross Weight	kg	115-130	115-130
Potência / Puissance / Potencia / Power	W	665	665
Tensão / Tension / Tensión / Tension	V	230	230



UDI  
fri

**BANCADAS GN 1/1 700 CONSERVAÇÃO E CONGELAÇÃO**

TABLES 700 GN 1/1 CONSERVATION ET CONGÉLATION

MESAS 700 GN 1/1 CONSERVACIÓN Y CONGELAMIENTO

700 GN 1/1 TABLES CONSERVATION AND FREEZING



**NOVO  
NOUVEAU  
NUEVO  
NEW**

5400.524



**NOVO  
NOUVEAU  
NUEVO  
NEW**

5400.528



**NOVO  
NOUVEAU  
NUEVO  
NEW**

5400.534

MODELO / MODÈLE / MODELO / MODEL		MGV210 TN GN1/1 2 PORTAS	MGV210 TN GN1/1 4 GAVETAS	MGV210 GN1/1 2 PORTAS VIDRO
CÓDIGO / CODE / CÓDIGO / CODE		5400.524	5400.528	5400.534
<b>Preço / Prix / Precio / Price</b>	<b>€</b>	<b>2.340,00</b>	<b>3.356,00</b>	<b>2.617,00</b>
Dimensões / Dimensions / Dimensiones	mm	1500x700x850	1500x700x850	1500x700x850
Volume / Volume / Volume / Volume	lt	330	330	330
Temperatura / Température / Temperatura / Temperature	°C	+2/+8	-2/+8	-2/+8
Gás refrigerante / Gaz réfrigérant / Gas refrigerante / Refrig. Gas		R290	R290	R290
Peso Líquido-Bruto/Poids Net-Brut/Peso Neto-Bruto/Net-Gross Weight	kg	100-110	120-135	110-125
Potência / Puissance / Potencia / Power	kW	377	377	377
Tensão / Tension / Tensión / Tension	V	230	230	230



**NOVO  
NOUVEAU  
NUEVO  
NEW**

5400.538



**NOVO  
NOUVEAU  
NUEVO  
NEW**

5400.542



**NOVO  
NOUVEAU  
NUEVO  
NEW**

5400.550

MODELO / MODÈLE / MODELO / MODEL		MGV310 TN GN1/1 3 PORTAS	MGV210 TN GN1/1 4GAVETAS+1PORTA	MGV310 GN1/1 3PORTAS VIDRO
CÓDIGO / CODE / CÓDIGO / CODE		5400.538	5400.542	5400.550
<b>Preço / Prix / Precio / Price</b>	<b>€</b>	<b>2.737,00</b>	<b>3.745,00</b>	<b>3.270,00</b>
Dimensões / Dimensions / Dimensiones	mm	2000x700x850	2000x700x850	2000x700x850
Volume / Volume / Volume / Volume	lt	515	515	515
Temperatura / Température / Temperatura / Temperature	°C	+2/+8	-2/+8	-2/+8
Gás refrigerante / Gaz réfrigérant / Gas refrigerante / Refrig. Gas		R290	R290	R290
Peso Líquido-Bruto/Poids Net-Brut/Peso Neto-Bruto/Net-Gross Weight	kg	135-150	145-160	130-145
Potência / Puissance / Potencia / Power	W	665	665	665
Tensão / Tension / Tensión / Tension	V	230	230	230



**CONJUNTO 3  
GAVETAS**  
2929.643  
**962,00**



**CONJUNTO 2  
GAVETAS**  
2929.642  
**702,00**

2929.509 2929.512



2929.506



MODELO / MODÈLE / MODELO / MODEL	MRV 140 TN 2P	MRV 140 TN 2PV	MRV 140 BT 2P
CÓDIGO / CODE / CÓDIGO / CODE	2929.509	2929.506	2929.512
<b>Preço / Prix / Precio / Price</b>	<b>€ 2.240,00</b>	<b>2.395,00</b>	<b>2.650,00</b>
Dimensões / Dimensions / Dimensiones	mm 1350x600x850	1350x600x850	1350x600x850
Volume / Volume / Volume / Volume	lt 230	230	230
Temperatura / Température / Temperatura / Temperature	°C +2/+8	+2/+8	-18/-22
Gás refrigerante / Gaz réfrigérant / Gas refrigerante / Refrig. Gas	R290	R290	R290
Peso Líquido / Poids Net / Peso Neto / Net Weight	kg 90	88	111
Consumo energia/ Consommation d'énergie/ Cons.Energia/ Energy Cons.	kWh/24h 1,8	1,8	5
Tensão / Tension / Tensión / Tension	V 230	230	230

2929.510 2929.513



2929.507



MODELO / MODÈLE / MODELO / MODEL	MRV 180 TN 3P	MRV 180 TN 3PV	MRV 180 BT 3P
CÓDIGO / CODE / CÓDIGO / CODE	2929.510	2929.507	2929.513
<b>Preço / Prix / Precio / Price</b>	<b>€ 2.545,00</b>	<b>2.850,00</b>	<b>2.896,00</b>
Dimensões / Dimensions / Dimensiones	mm 1800x600x850	1800x600x850	1800x600x850
Volume / Volume / Volume / Volume	lt 358	358	358
Temperatura / Température / Temperatura / Temperature	°C +2/+8	+2/+8	-18/-22
Gás refrigerante / Gaz réfrigérant / Gas refrigerante / Refrig. Gas	R290	R290	R290
Peso Líquido / Poids Net / Peso Neto / Net Weight	kg 114	116	137
Consumo energia/ Consommation d'énergie/ Cons.Energia/ Energy Cons.	kWh/24h 2,2	2,2	7
Tensão / Tension / Tensión / Tension	V 230	230	230



MODELO / MODÈLE / MODELO / MODEL	MRV 220 TN 4PV
CÓDIGO / CODE / CÓDIGO / CODE	2929.508
<b>Preço / Prix / Precio / Price</b>	<b>€ 3.395,00</b>
Dimensões / Dimensions / Dimensiones	mm 2250x600x850
Volume / Volume / Volume / Volume	lt 485
Temperatura / Température / Temperatura / Temperature	°C +2/+8
Gás refrigerante / Gaz réfrigérant / Gas refrigerante / Refrig. Gas	R290
Peso Líquido / Poids Net / Peso Neto / Net Weight	kg 142
Consumo energia/ Consommation d'énergie/ Cons.Energia/ Energy Cons.	kWh/24h 2,6
Tensão / Tension / Tensión / Tension	V 230

Sem grupo sob consulta / Sans groupe sur demande / Sin grupo bajo demanda / Without group version on request

Inclui uma prateleira + um par de guias por porta / Comprend une étagère + un couple de guides pour port / Incluye un estante por un par de guias de puerta / + Includes a shelf for a couple of guides port





udi fri

**BANCADAS GN 1/1 700 CONSERVAÇÃO E CONGELAÇÃO**

TABLES 700 GN 1/1 CONSERVATION ET CONGÉLATION

MESAS 700 GN 1/1 CONSERVACIÓN Y CONGELAMIENTO

700 GN 1/1 TABLES CONSERVATION AND FREEZING



**MGV = GASTRO 1/1**



**CONJUNTO 3 GAVETAS**  
2929.641  
**962,00**



**CONJUNTO 2 GAVETAS**  
2929.640  
**712,00**



2929.526 2929.532



2929.520



MODELO / MODÈLE / MODELO / MODEL	MGV 210 TN - 2P.	MGV 210 TN PV+ILUM	MGV 210 BT - 2P.
CÓDIGO / CODE / CÓDIGO / CODE	2929.526	2929.520	2929.532
<b>Preço / Prix / Precio / Price</b>	<b>€ 2.254,00</b>	<b>2.338,00</b>	<b>2.780,00</b>
Dimensões / Dimensions / Dimensiones	mm 1350 x 700 x 850	1350 x 700 x 850	1350 x 700 x 850
Volume / Volume / Volume / Volume	lt 260	260	260
Temperatura / Température / Temperatura / Temperature	°C -2/+8	+2/+8	-18/-22
Gás refrigerante / Gaz réfrigérant / Gas refrigerante / Refrig. Gas	R290	R290	R290
Peso Líquido / Poids Net / Peso Neto / Net Weight	kg 100	101	113
Consumo energia/ Consommation d'énergie/ Cons.Energia/ Energy Cons.	kWh/24h 2	2	7
Tensão / Tension / Tensión / Tension	V 230	230	230

2929.528 2929.534



2929.522



MODELO / MODÈLE / MODELO / MODEL	MGV 310 TN - 3P.	MGV 310 TN PV+ILUM	MGV 310 BT - 3P.
CÓDIGO / CODE / CÓDIGO / CODE	2929.528	2929.522	2929.534
<b>Preço / Prix / Precio / Price</b>	<b>€ 2.560,00</b>	<b>2.620,00</b>	<b>3.185,00</b>
Dimensões / Dimensions / Dimensiones	mm 1800 x 700 x 850	1800 x 700 x 850	1800 x 700 x 850
Volume / Volume / Volume / Volume	lt 400	400	400
Temperatura / Température / Temperatura / Temperature	°C -2/+8	+2/+8	-18/-22
Gás refrigerante / Gaz réfrigérant / Gas refrigerante / Refrig. Gas	R290	R290	R290
Peso Líquido / Poids Net / Peso Neto / Net Weight	kg 124	126	150
Consumo energia/ Consommation d'énergie/ Cons.Energia/ Energy Cons.	kWh/24h 2,4	2,4	8
Tensão / Tension / Tensión / Tension	V 230	230	230

5 níveis em cada porta  
5 niveaux sur chaque porte  
5 niveles en cada puerta  
5 stages on each door

Painel eletrónico com termostato digital  
Tableau de commande électronique avec thermostat digital  
Panel electrónico con termostato digital  
Electronic panel with digital thermostat

Inclui uma prateleira + um par de guias por porta / Comprend une étagère + un couple de guides pour port / Incluye un estante por un par de guias de puerta / + Indudes a shelf + a couple of guides per door



opcional  
opcionnel  
opcional  
optional



**NOVO  
NOUVEAU  
NUEVO  
NEW**



MODELO / MODÈLE / MODELO / MODEL		MPPR - R 1510X800
CÓDIGO / CODE / CÓDIGO / CODE		2929.653
<b>Preço / Prix / Precio / Price</b>	€	<b>2.524,00</b>
Dimensões / Dimensions / Dimensiones	mm	1510x800x850
Temperatura / Température / Temperatura / Temperature	°C	+2/+8
Volume / Volume / Volume / Volume	Lt	390
Gás refrigerante / Gaz réfrigérant / Gas refrigerante / Refrig. Gas		R290
Prateleira Euronorm / Étagère Euronorm / Estante Euronorm / Euronorm Shelf	mm	600x400
Peso Líquido-Bruto / Poids Net-Brut / Peso Neto-Bruto / Net-Gross Weight	kg	109-126
Potência / Puissance / Potencia / Power	kW	0,215
Tensão / Tension / Tensión / Tension	V	230

**NOVO  
NOUVEAU  
NUEVO  
NEW**



MODELO / MODÈLE / MODELO / MODEL		MPPR - R 2020X800
CÓDIGO / CODE / CÓDIGO / CODE		2929.657
<b>Preço / Prix / Precio / Price</b>	€	<b>2.964,00</b>
Dimensões / Dimensions / Dimensiones	mm	2020x800x850
Temperatura / Température / Temperatura / Temperature	°C	+2/+8
Volume / Volume / Volume / Volume	Lt	580
Gás refrigerante / Gaz réfrigérant / Gas refrigerante / Refrig. Gas		R290
Prateleira Euronorm / Étagère Euronorm / Estante Euronorm / Euronorm Shelf	mm	600x400
Peso Líquido-Bruto / Poids Net-Brut / Peso Neto-Bruto / Net-Gross Weight	kg	158-159
Potência / Puissance / Potencia / Power	kW	0,320
Tensão / Tension / Tensión / Tension	V	230

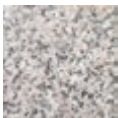

Granito Pink / Granit Pink /  
Granito Pink / Pink granit

**Standard:**

**1 prateleira Euronorm (600x400mm), por cada porta**

1 étagère Euronorm (600x400mm), sur chaque porte

1 estante Euronorm (600x400mm), en cada puerta

1 Euronorm shelf (600x400mm), on each door.

**9 níveis em cada porta**

9 niveaux sur chaque porte

9 niveles en cada puerta

9 levels on each door

MODELO / MODÈLE / MODELO / MODEL		MPPR - R 1510X800
CÓDIGO / CODE / CÓDIGO / CODE		2929.652
<b>Preço / Prix / Precio / Price</b>	€	<b>2.715,00</b>
Dimensões / Dimensions / Dimensiones	mm	1510x800x850
Temperatura / Température / Temperatura / Temperature	°C	+2/+8
Volume / Volume / Volume / Volume	Lt	430
Gás refrigerante / Gaz réfrigérant / Gas refrigerante / Refrig. Gas		R290
Prateleira Euronorm / Étagère Euronorm / Estante Euronorm / Euronorm Shelf	mm	600x400
Peso Líquido-Bruto / Poids Net-Brut / Peso Neto-Bruto / Net-Gross Weight	kg	126
Consumo energia/ Consommation d'énergie/ Cons.Energia/Energy Cons.	kW/24h	3
Tensão / Tension / Tensión / Tension	V	230

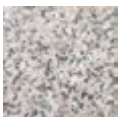

Granito Pink / Granit Pink /  
Granito Pink / Pink granit



MODELO / MODÈLE / MODELO / MODEL		MPPR - R 2020X800
CÓDIGO / CODE / CÓDIGO / CODE		2929.654
<b>Preço / Prix / Precio / Price</b>	€	<b>3.217,00</b>
Dimensões / Dimensions / Dimensiones	mm	2020x800x850
Temperatura / Température / Temperatura / Temperature	°C	+2/+8
Volume / Volume / Volume / Volume	Lt	640
Gás refrigerante / Gaz réfrigérant / Gas refrigerante / Refrig. Gas		R290
Prateleira Euronorm / Étagère Euronorm / Estante Euronorm / Euronorm Shelf	mm	600x400
Peso Líquido-Bruto / Poids Net-Brut / Peso Neto-Bruto / Net-Gross Weight	kg	158
Consumo energia/ Consommation d'énergie/ Cons.Energia/Energy Cons.	kW/24h	3,6
Tensão / Tension / Tensión / Tension	V	230





UDIfri

## MESAS DE PIZZA COM VITRINES DE BALÇÃO

TABLES DU PIZZA AVEC VITRINES DE COMPTOIR

TABLA DE PIZZA CON VITRINA DE MOSTRADOR

PIZZA TABLES WITH COUNTER CABINETS



### Standard:

1 prateleira GN1/1, por cada porta  
1 étagère GN1/1, sur chaque port  
1 estante GN1/1, en cada puerta  
1 GN1/1 shelf, on each port.

### Modelos MPR Standard:

2 guias Euronorm para tabuleiro (600x400mm) por porta  
2 guides Euronorm pour plateaux (600x400mm) pour port  
2 guias Euronorm para bandeja (600x400mm) por puerta  
2 Euronorm tray guides (600x400mm) per door

Containers não incluídos  
Containers non inclu  
Containers non include  
Containers not included



MODELO / MODÈLE / MODELO / MODEL	MPP-R-1510 2P	
CÓDIGO / CODE / CÓDIGO / CODE	2929.705	
<b>Preço / Prix / Precio / Price</b>	<b>€</b>	<b>4.280,00</b>
Dimensões / Dimensions / Dimensiones	mm	1500x800x1040
Dim. Vitrine / Dim. Vitrine / Dim. Vitrina / Dim. Cabinet	mm	1500x335x435
Volume / Volume / Volume / Volume	lt	430 (7x GN 1/4)
Temperatura / Température / Temperatura / Temperature	°C	+2/+8
Refrigeração / Refrigeration / Refrigeracion / Cooling	S/V*	S/V
Peso Líquido / Poids Net / Peso Neto / Net Weight	kg	216+42,5
Consumo energia / Consommation d'énergie / Cons.Energia / Energy Cons.	kWh/24h	2,4+1,4
Tensão / Tension / Tensión / Tension	V	230



MODELO / MODÈLE / MODELO / MODEL	MPS 140 3P	
CÓDIGO / CODE / CÓDIGO / CODE	2929.820	
<b>Preço / Prix / Precio / Price</b>	<b>€</b>	<b>3.618,00</b>
Dimensões / Dimensions / Dimensiones	mm	1400x700x1020
Dim. Vitrine / Dim. Vitrine / Dim. Vitrina / Dim. Cabinet	mm	1400x335x435
Volume / Volume / Volume / Volume	lt	350 (6xGN 1/4)
Temperatura / Température / Temperatura / Temperature	°C	+2/+8
Refrigeração / Refrigeration / Refrigeracion / Cooling	S/V*	S/V
Peso Líquido / Poids Net / Peso Neto / Net Weight	kg	199+40,5
Consumo energia / Consommation d'énergie / Cons.Energia / Energy Cons.	kWh/24h	3,5+1,4
Tensão / Tension / Tensión / Tension	V	230



MODELO / MODÈLE / MODELO / MODEL	MPR 2020 3P	
CÓDIGO / CODE / CÓDIGO / CODE	2929.715	
<b>Preço / Prix / Precio / Price</b>	<b>€</b>	<b>4.880,00</b>
Dimensões / Dimensions / Dimensiones	mm	2025x800x1040
Dim. Vitrine / Dim. Vitrine / Dim. Vitrina / Dim. Cabinet	mm	2000x335x435
Volume / Volume / Volume / Volume	lt	640 (10xGN 1/4)
Temperatura / Température / Temperatura / Temperature	°C	+2/+8
Refrigeração / Refrigeration / Refrigeracion / Cooling	S/V*	S/V
Peso Líquido / Poids Net / Peso Neto / Net Weight	kg	296+51
Consumo energia / Consommation d'énergie / Cons.Energia / Energy Cons.	kWh/24h	2,9+1,7
Tensão / Tension / Tensión / Tension	V	230



\*V = Ventilada / Ventilé / Ventilada / Ventilated | S = Estática / Static / Estática / Static  
# Com cobertura / Avec couverture / Con cobertura / With cover



**NOVO**  
**NOUVEAU**  
**NUEVO**  
**NEW**



zona neutra  
zone neutre  
zona neutra  
neutral zone

MODELO / MODÈLE / MODELO / MODEL	MPR1500-1P 5GAV	
CÓDIGO / CODE / CÓDIGO / CODE	2929.703	
<b>Preço / Prix / Precio / Price</b>	<b>€</b>	<b>4.245,00</b>
Dimensões / Dimensions / Dimensiones	mm	1500x800x1040
Dim. Vitrine / Dim. Vitrine / Dim. Vitrina / Dim. Cabinet	mm	1500x395x440
Volume / Volume / Volume / Volume	lt	220+58
Temperatura / Température / Temperatura / Temperature	°C	+2/+8
Refrigeração / Refrigeration / Refrigeracion / Cooling	S/V*	S/V
Peso Líquido / Poids Net / Peso Neto / Net Weight	kg	216+46
Consumo energia / Consommation d'énergie / Cons.Energia / Energy Cons.	kWh/ 24h	2,08+1,5
Tensão / Tension / Tensión / Tension	V	230



zona neutra  
zone neutre  
zona neutra  
neutral zone

MODELO / MODÈLE / MODELO / MODEL	MPR-2025 2P+5 GAV.	
CÓDIGO / CODE / CÓDIGO / CODE	2929.710	
<b>Preço / Prix / Precio / Price</b>	<b>€</b>	<b>4.760,00</b>
Dimensões / Dimensions / Dimensiones	mm	2025x800x1040
Dim. Vitrine / Dim. Vitrine / Dim. Vitrina / Dim. Cabinet	mm	2000x335x435
Volume / Volume / Volume / Volume	lt	430 (10xGN 1/4)
Temperatura / Température / Temperatura / Temperature	°C	+2/+8
Refrigeração / Refrigeration / Refrigeracion / Cooling	S/V*	S/V
Peso Líquido / Poids Net / Peso Neto / Net Weight	kg	296+51
Consumo energia / Consommation d'énergie / Cons.Energia / Energy Cons.	kWh/ 24h	2,4+1,7
Tensão / Tension / Tensión / Tension	V	230

\*V = Ventilada / Ventilé / Ventilada / Ventilated | S = Estática / Static / Estática / Static  
# Com cobertura / Avec couverture / Con cobertura / With cover



UDIfri

MESAS DE SALADAS  
TABLE DES SALADES  
MESA DE ENSALADAS  
SALADS TABLE



**Standard:**

1 prateleira Euronorm, por cada porta  
1 étagère Euronorm, sur chaque port  
1 estante Euronorm, en cada puerta  
1 Euronorm shelf, on each port.



MODELO / MODÈLE / MODELO / MODEL CÓDIGO / CODE / CÓDIGO / CODE		MSR 900 -2P 2929.810
<b>Preço / Prix / Precio / Price</b>	<b>€</b>	<b>1.306,00</b>
Dimensões / Dimensions / Dimensiones	mm	900x700x883
Volume / Volume / Volume / Volume	lt	215
Temperatura / Température / Temperatura / Temperature	°C	0/+8
Gás refrigerante / Gaz réfrigérant / Gas refrigerante / Refrig. Gas		R600a
Refrigeração / Refrigeration / Refrigeracion / Cooling	S/V	S
Peso Líquido / Poids Net / Peso Neto / Net Weight	kg	87
Potência / Puissance / Potencia / Power	W	142,4
Tensão / Tension / Tensión / Tension	V	230



MODELO / MODÈLE / MODELO / MODEL CÓDIGO / CODE / CÓDIGO / CODE		MSR 900 -2P POLIETILENO 2929.805	MSR 1045 - 2P POLIETILENO 2929.815
<b>Preço / Prix / Precio / Price</b>	<b>€</b>	<b>1.268,00</b>	<b>1.440,00</b>
Dimensões / Dimensions / Dimensiones	mm	900x700x850	1045x700x883
Volume / Volume / Volume / Volume	lt	230	270
Temperatura / Température / Temperatura / Temperature	°C	0/+8	0/+8
Gás refrigerante / Gaz réfrigérant / Gas refrigerante / Refrig. Gas		R600a	R600a
Refrigeração / Refrigeration / Refrigeracion / Cooling	S/V	S	S
Peso Líquido / Poids Net / Peso Neto / Net Weight	kg	86	87
Potência / Puissance / Potencia / Power	W	142,4	182
Tensão / Tension / Tensión / Tension	V	230	230

\*V = Ventilada / Ventilé / Ventilada / Ventilated | S = Estática / Static / Estática / Static



**EIB**

Containers não incluídos (Altura máxima 150mm)  
Containers non inclu (Hauteur máx. 150mm)  
Containers no incluidos (Hauteur máx. 150mm)  
Containers not included (Máx. height 150mm)

Com cobertura  
Avec couverture  
Con cobertura  
With cover

a -  
Inclui medidas vidro  
Comprend mesures du verre  
Incluye medidas vidrio  
Includes glass measures

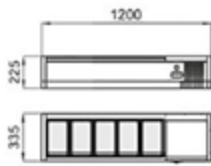

GN 1/4

MODELO / MODÈLE / MODELO / MODEL	EIB 120 - 330	
CÓDIGO / CODE / CÓDIGO / CODE	2929.945	
<b>Preço / Prix / Precio / Price</b>	<b>€</b>	<b>980,00</b>
Dimensões / Dimensions / Dimensiones	mm	1200x335x 435a
Temperatura / Température / Temperatura / Temperature	°C	+2/+8
Capacidade / Capacité / Capacidad / Capacity	GN	5xGN 1/4
Gás refrigerante / Gaz réfrigérant / Gas refrigerante / Cooling gas		R600a
Refrigeração / Refrigeration / Refrigeracion / Cooling	S/V*	S
Peso Bruto/ Poids Brut / Peso Bruto / Gross Weight	kg	37
Consumo energia / Consommation d'énergie / Cons.Energia /Energy Cons.	kWh/ 24h	1,2
Tensão / Tension / Tensión / Tension	V	230

**NOVO**  
**NOUVEAU**  
**NUEVO**  
**NEW**



GN 1/4

MODELO / MODÈLE / MODELO / MODEL	EIB 140 - 330	
CÓDIGO / CODE / CÓDIGO / CODE	2929.950	
<b>Preço / Prix / Precio / Price</b>	<b>€</b>	<b>1.070,00</b>
Dimensões / Dimensions / Dimensiones	mm	1400x335x425
Temperatura / Température / Temperatura / Temperature	°C	+2/+8
Capacidade / Capacité / Capacidad / Capacity	GN	6xGN1/4
Gás refrigerante / Gaz réfrigérant / Gas refrigerante / Cooling gas		R600a
Refrigeração / Refrigeration / Refrigeracion / Cooling	S/V*	S
Peso Bruto/ Poids Brut / Peso Bruto / Gross Weight	kg	64
Consumo energia / Consommation d'énergie / Cons.Energia /Energy Cons.	kWh/ 24h	1,4
Tensão / Tension / Tensión / Tension	V	230

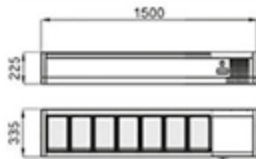

GN 1/4

MODELO / MODÈLE / MODELO / MODEL	EIB 150-330	
CÓDIGO / CODE / CÓDIGO / CODE	2929.955	
<b>Preço / Prix / Precio / Price</b>	<b>€</b>	<b>1.100,00</b>
Dimensões / Dimensions / Dimensiones	mm	1500x335x 440a
Temperatura / Température / Temperatura / Temperature	°C	+2/+8
Capacidade / Capacité / Capacidad / Capacity	GN	7xGN 1/4
Gás refrigerante / Gaz réfrigérant / Gas refrigerante / Cooling gas		R600a
Refrigeração / Refrigeration / Refrigeracion / Cooling	S/V*	S
Peso Bruto/ Poids Brut / Peso Bruto / Gross Weight	kg	42,5
Consumo energia / Consommation d'énergie / Cons.Energia /Energy Cons.	kWh/ 24h	1,4
Tensão / Tension / Tensión / Tension	V	230



3x GN 1/3  
+  
1 GN 1/2

MODELO / MODÈLE / MODELO / MODEL	EIB 120-380	
CÓDIGO / CODE / CÓDIGO / CODE	2929.947	
<b>Preço / Prix / Precio / Price</b>	<b>€</b>	<b>1.020,00</b>
Dimensões / Dimensions / Dimensiones	mm	1200x395x 440
Temperatura / Température / Temperatura / Temperature	°C	+2/+8
Capacidade / Capacité / Capacidad / Capacity	GN	3xGN1/3 + 1xGN1/2
Gás refrigerante / Gaz réfrigérant / Gas refrigerante / Cooling gas		R600a
Refrigeração / Refrigeration / Refrigeracion / Cooling	S/V*	S
Peso Bruto/ Poids Brut / Peso Bruto / Gross Weight	kg	40
Consumo energia / Consommation d'énergie / Cons.Energia /Energy Cons.	kWh/ 24h	-
Tensão / Tension / Tensión / Tension	V	230

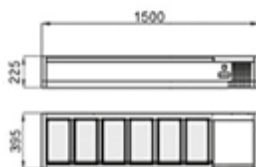

GN 1/3

MODELO / MODÈLE / MODELO / MODEL	EIB150-380	
CÓDIGO / CODE / CÓDIGO / CODE	2929.957	
<b>Preço / Prix / Precio / Price</b>	<b>€</b>	<b>1.150,00</b>
Dimensões / Dimensions / Dimensiones	mm	1500x395x 440
Temperatura / Température / Temperatura / Temperature	°C	+2/+8
Capacidade / Capacité / Capacidad / Capacity	GN	5xGN1/3 + 1xGN1/2
Gás refrigerante / Gaz réfrigérant / Gas refrigerante / Cooling gas		R600a
Refrigeração / Refrigeration / Refrigeracion / Cooling	S/V*	S
Peso Bruto/ Poids Brut / Peso Bruto / Gross Weight	kg	46
Consumo energia / Consommation d'énergie / Cons.Energia /Energy Cons.	kWh/ 24h	1,5
Tensão / Tension / Tensión / Tension	V	230

\*V = Ventilada / Ventilé / Ventilada / Ventilated | S = Estática / Static / Estática / Static  
cobertura / With cover

#Com cobertura / Avec couverture / Con



UDIfri

VITRINES DE BALÇÃO  
VITRINES DE COMPTOIR  
VITRINAS DE MOSTRADOR  
COUNTER CABINETS



Containers não incluídos (Altura máxima 150mm)  
Containers non inclu (Hauteur máx. 150mm)  
Containers no incluídos (Hauteur máx. 150mm)  
Containers not included (Máx. height 150mm)

Com cobertura  
Avec couverture  
Con cobertura  
With cover

a -  
Inclui medidas vidro  
Comprend mesures du verre  
Incluye medidas vidrio  
Includes glass measures

EIB



GN 1/4

MODELO / MODÈLE / MODELO / MODEL CÓDIGO / CODE / CÓDIGO / CODE	EIB 160-330 2929.958	
<b>Preço / Prix / Precio / Price</b>	€	<b>1.190,00</b>
Dimensões / Dimensions / Dimensiones	mm	1600x395x440
Temperatura / Température / Temperatura / Temperature	°C	+2/+8
Capacidade / Capacité / Capacidad / Capacity	GN	7xGN 1/4
Gás refrigerante / Gaz réfrigérant / Gas refrigerante / Cooling gas		R600a
Refrigeração / Refrigeration / Refrigeracion / Cooling	S/V*	S
Peso Bruto/ Poids Brut / Peso Bruto / Gross Weight	kg	30
Tensão / Tension / Tensión / Tension	V	230

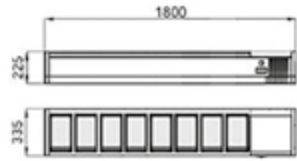

GN 1/4

MODELO / MODÈLE / MODELO / MODEL CÓDIGO / CODE / CÓDIGO / CODE	EIB 180-330 2929.960	
<b>Preço / Prix / Precio / Price</b>	€	<b>1.230,00</b>
Dimensões / Dimensions / Dimensiones	mm	1800x335x440a
Temperatura / Température / Temperatura / Temperature	°C	+2/+8
Capacidade / Capacité / Capacidad / Capacity	GN	8xGN 1/4
Gás refrigerante / Gaz réfrigérant / Gas refrigerante / Cooling gas		R600a
Refrigeração / Refrigeration / Refrigeracion / Cooling	S/V*	S
Peso Bruto/ Poids Brut / Peso Bruto / Gross Weight	kg	47,5
Consumo energia / Consommation d'énergie / Cons.Energia /Energy Cons.	kWh/ 24h	1,6
Tensão / Tension / Tensión / Tension	V	230

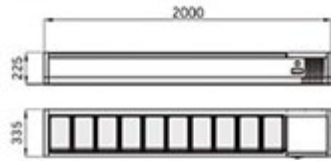

GN 1/4

MODELO / MODÈLE / MODELO / MODEL CÓDIGO / CODE / CÓDIGO / CODE	EIB 200-330 2929.965	
<b>Preço / Prix / Precio / Price</b>	€	<b>1.362,00</b>
Dimensões / Dimensions / Dimensiones	mm	2000x335x440a
Temperatura / Température / Temperatura / Temperature	°C	+2/+8
Capacidade / Capacité / Capacidad / Capacity	GN	10xGN 1/4
Gás refrigerante / Gaz réfrigérant / Gas refrigerante / Cooling gas		R600a
Refrigeração / Refrigeration / Refrigeracion / Cooling	S/V*	S
Peso Bruto/ Poids Brut / Peso Bruto / Gross Weight	kg	51
Consumo energia / Consommation d'énergie / Cons.Energia /Energy Cons.	kWh/ 24h	1,7
Tensão / Tension / Tensión / Tension	V	230



GN 1/3

MODELO / MODÈLE / MODELO / MODEL CÓDIGO / CODE / CÓDIGO / CODE	EIB 180-380 2929.962	
<b>Preço / Prix / Precio / Price</b>	€	<b>1.290,00</b>
Dimensões / Dimensions / Dimensiones	mm	1800x 395x440
Temperatura / Température / Temperatura / Temperature	°C	+2/+8
Capacidade / Capacité / Capacidad / Capacity	GN	8xGN1/3
Gás refrigerante / Gaz réfrigérant / Gas refrigerante / Cooling gas		R600a
Refrigeração / Refrigeration / Refrigeracion / Cooling	S/V*	S
Peso Bruto/ Poids Brut / Peso Bruto / Gross Weight	kg	52
Consumo energia / Consommation d'énergie / Cons.Energia /Energy Cons.	kWh/ 24h	1,8
Tensão / Tension / Tensión / Tension	V	230

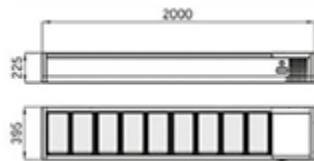

GN 1/3

MODELO / MODÈLE / MODELO / MODEL CÓDIGO / CODE / CÓDIGO / CODE	EIB200-380 2929.968	
<b>Preço / Prix / Precio / Price</b>	€	<b>1.420,00</b>
Dimensões / Dimensions / Dimensiones	mm	2000x395x440
Temperatura / Température / Temperatura / Temperature	°C	+2/+8
Capacidade / Capacité / Capacidad / Capacity	GN	9xGN 1/3X9
Gás refrigerante / Gaz réfrigérant / Gas refrigerante / Cooling gas		R600a
Refrigeração / Refrigeration / Refrigeracion / Cooling	S/V*	S
Peso Bruto/ Poids Brut / Peso Bruto / Gross Weight	kg	56
Consumo energia / Consommation d'énergie / Cons.Energia /Energy Cons.	kWh/ 24h	1,8
Tensão / Tension / Tensión / Tension	V	230

\*V = Ventilada / Ventilé / Ventilada / Ventilated | S = Estática / Static / Estática / Static  
cobertura / With cover

#Com cobertura / Avec couverture / Con



Estrutura interna em aço inoxidável AISI 304; Iluminação interna com "luz" Led específica para carne; Equipada com duas prateleiras 600x 560 mm+ 1 gancho em aço inox;

UDICAR 1 e UDICAR 2 Ideais para exposição de carne fresca.

UDICAR1 MATURAÇÃO e UDICAR2 MATURAÇÃO para conservação e maturação da carne até 12 meses.

UDICAR1 FISH e UDICAR2 FISH ideal para conservação de peixe. Evaporador tratado e inclui 2 grelhas.



Structure interne en acier inoxydable AISI 304; Éclairage interne avec "light" LED spécifique pour la viande; Equipé avec deux étagères 600x560 mm + 1 crochet en acier inoxydable;

UDICAR 1 et UDICAR 2 Idéal pour l'exposition de la viande fraîche.

UDICAR1 MATURAÇÃO et UDICAR2 MATURAÇÃO pour la conservation et la maturation de la viande jusqu'à 12 mois.

UDICAR1 FISH et UDICAR2 FISH idéal pour la conservation du poisson. Evaporador traité et comprend 2 grils.



Estructura interna de acero inoxidable AISI 304; Iluminación interna con "luz" Led específica para carne; Equipada con dos estantes 600x 560 mm + 1 gancho en acero inoxidable;

UDICAR 1 y UDICAR 2 Ideal para la exposición de carne fresca.

UDICAR1 MATURAÇÃO y UDICAR2 MATURAÇÃO para la conservación y maduración de la carne hasta 12 meses.

UDICAR1 FISH y UDICAR2 FISH ideal para la conservación de pescado. Evaporador tratado e incluye 2 rejillas.



Internal structure in stainless steel AISI 304; Internal lighting with "light" Specific LED for meat; Equipped with two shelves 600x560 mm + 1 hook in stainless steel;

UDICAR 1 and UDICAR 2 Ideal for fresh meat exposure.

UDICAR1 MATURAÇÃO and UDICAR2 MATURAÇÃO for preservation and maturation of the meat up to 12 months.

UDICAR1 FISH and UDICAR2 FISH ideal for fish conservation. Evaporador treated and includes 2 grills.



**Carne Fresca**  
**Viande fraîche**  
**Carne fresca**  
**Fresh Meat**

**Dry Age**  
**Viande fraîche**  
**Carne fresca**  
**Fresh Meat**

**Carne maturada**  
**Viande mature**  
**Carne madura**  
**Matured meat**

MODELO / MODÈLE / MODELO / MODEL							
CÓDIGO / CODE / CÓDIGO / CODE		UDICAR1	UDICAR2	UDICAR1 MATURAÇÃO	UDICAR2 MATURAÇÃO	UDICAR1 FISH	UDICAR2 FISH
		2093.702	2093.708	2093.706	2093.712	2093.720	2093.722
<b>Preço / Prix / Precio / Price</b>	<b>€</b>	<b>6.167,00</b>	<b>8.473,00</b>	<b>10.075,00</b>	<b>12.380,00</b>	<b>6.629,00</b>	<b>8.935,00</b>
Dimensões / Dimensions / Dimensiones	mm	760x 760x 1930	1500x 760x 1930	760x 760x 1990	1500x 760x 1990	760x 760x 1960	1500x 760x 1930
Volume / Volumen / Volume / Volume	lt	550	1150	550	1150	550	1150
Temperatura Refrigeração / Temp. Refroidissement / Temp. Enfriamiento / Cooling Temp.	°C	-5 / +10	-5 / +10	0/+20	0/+20	-5 / +10	-5 / +10
Humidade Relativa / Humidité / Humedad / Relative Humidity	%	-	-	80	80	-	-
Gás refrigerante / Gaz réfrigérant / Gas refrigerante / Cooling gas		R452	R452	R452	R452	R452	R452
Descongelação / Décongélation / Descongelacion / Defrosting	A/M**	A	A	A	A	A	A
Refrigeração / Refrigeration / Refrigeracion / Cooling		NO-FROST	NO-FROST	NO-FROST	NO-FROST	-	-
Dimensão prateleira / Dimensions grilles / Dimensiones rejillas / Grids dimensions	mm	600X560	600X560	600X560	600X560	600X560	600X560
Prateleiras / Étagères / Estantes / Shelves	nr	2	2+2	2	2+2	2	2+2
Peso Líquido-Bruto / Poids Net-Brut / Peso Neto-Bruto / Net-Gross Weight	kg	190-205	280-300	190-205	280-300	190-205	280-300
Potência Elétrica / Puissance Électrique / Potencia Eléctrica / Electric Power	W	600	800	600	800	500	800
Tensão / Tension / Tensión / Tension	V	230	230	230	230	230	230



confirmar disponibilidade dos produtos desta página  
 confirmer la disponibilité des produits sur cette page  
 confirmar la disponibilidad de los productos de esta página  
 confirm the availability of the products on this page



UDI fri

## EXPOSITORES PROFSSIONAIS CARNE MATURADA

VITRINES VIEILLISSEMENT DE VIANDE  
ARMARIOS DE MADURACIÓN DE CARNE  
MEAT AGING PROFESSIONAL DISPLAYS



Expositores profissionais para envelhecimento de carne de porta de vidro para observar diretamente o envelhecimento e afinação do produto - ambiente seguro e controlado, graças à lâmpada UV germicida - temperatura, humidade e ventilação constantes que garantem um processo de envelhecimento perfeito. Caixa externa em chapa pintada de preto - caixa interna em ABS antibacteriano - suporte e ganchos em aço inoxidável AISI 304 - sensor de abertura da porta - aviso acústico para sinalizar falhas



Exposants professionnels pour le vieillissement de la viande de porte en verre pour observer directement le vieillissement et le réglage du produit - environnement sûr et contrôlé, grâce à la lampe stermicide UV - température, humidité et ventilation constantes qui garantissent un processus de vieillissement parfait. Boîtier externe en tôle peinte en noir - boîtier interne en ABS antibactérien - support et crochets en acier inoxydable AISI 304 - capteur d'ouverture de porte - avertissement acoustique pour signaler les défauts.



Expositores profesionales para el envejecimiento de la carne en puertas de vidrio para observar directamente el envejecimiento y la puesta a punto del producto - ambiente seguro y controlado, gracias a la lámpara germicida UV - temperatura, humedad y ventilación constantes que garantizan un proceso de envejecimiento perfecto. Caja externa en placa pintada de negro - caja interna en ABS antibacteriano - soporte y ganchos en acero inoxidable AISI 304 - sensor de apertura de puerta - advertencia acústica para señalar falhas.



Professional displays for glass door meat aging to directly observe the aging and tuning of the product - safe and controlled environment, thanks to the UV stermicide lamp - constant temperature, humidity and ventilation that guarantee a perfect aging process. External housing in black painted sheet - internal housing in antibacterial ABS - support and hooks in AISI 304 stainless steel - door opening sensor - acoustic warning to signal faults.



MODELO / MODÈLE / MODELO / MODEL	UGDMA40 88L	UGDMA46 98L	UGDMA120 233L
CÓDIGO / CODE / CÓDIGO / CODE	3500.401	3500.399	3500.397
<b>Preço / Prix / Precio / Price</b>	<b>€ 3.494,00</b>	<b>4.132,00</b>	<b>5.644,00</b>
Dimensões / Dimensions / Dimensiones	mm 485x 600x 820	595x 570x 820	595x 710x 1270
Volume / Volumen / Volume / Volume	lt 88	98	233
Temperatura Refrigeração / Température Refroidissement / Temperatura Enfriamiento / Cooling Temperature	°C +1/+25	+1/+25	+1/+25
Humidade Relativa / Humidité / Humedad / Relative Humidity	% 60-85	60-85	60-85
Gás refrigerante / Gaz réfrigérant / Gas refrigerante / Cooling gas	R600A	R600A	R600A
Descongelamento / Décongélation / Descongelacion / Defrosting	A/M** A	A	A
Refrigeração / Refrigeration / Refrigeracion / Cooling	S/V* V	V	V
Ganchos / Crochets / Ganchos / Hooks	nr 3	3	3
Peso Líquido-Bruto / Poids Net-Brut / Net-Gross Weight	kg 37-40	44-47	69-81
Potência Elétrica / Puissance Électrique / Potencia Eléctrica / Electric Power	W 140	140	170
Tensão / Tension / Tensión / Tension	V 230	230	230



Minibar com luz interior LED  
Com porta opaca e reversivel  
Sem compressor  
Sem vibrações  
Sem gases CFC



Minibar avec éclairage intérieur LED  
Avec porte opaque et réversible  
Sans compresseur  
Sans vibrations  
Sans CFC



Minibar con luz interior LED  
Con puerta opaca y reversible  
Sin el compresor  
Sin vibraciones  
Sin CFC



Minibar with interior light LED  
With opaque and reversible door  
Without compressor  
Without vibrations  
Without CFC



MODELO / MODÈLE / MODELO / MODEL	UDMB35	
CÓDIGO / CODE / CÓDIGO / CODE	2829.680	
<b>Preço/ Prix /Precio/ Price</b>	<b>€</b>	<b>381,00</b>
Dimensões / Dimensions / Dimensiones	mm	385x455x485
Volume / Volume / Volume / Volume	lt	35
Temperatura / Température / Temperatura / Température	°C	+8
Prateleiras / Étagère / Estante / Shelf	nr	2
Potência / Puissance / Potência / Power	W	63
Peso Líquido-Bruto /Poids Net-Brut /Peso Neto-Bruto /Net-Gross Weight	kg	10,2-11,5
Tensão / Tension / Tension / Tension	V	230



MODELO / MODÈLE / MODELO / MODEL	UDMB45	
CÓDIGO / CODE / CÓDIGO / CODE	2829.682	
<b>Preço/ Prix /Precio/ Price</b>	<b>€</b>	<b>445,00</b>
Dimensões / Dimensions / Dimensiones	mm	400x425x560
Volume / Volume / Volume / Volume	lt	40
Temperatura / Température / Temperatura / Température	°C	+8
Prateleiras / Étagère / Estante / Shelf	nr	2
Potência / Puissance / Potência / Power	W	63
Peso Líquido-Bruto /Poids Net-Brut /Peso Neto-Bruto /Net-Gross Weight	kg	12,30-14,20
Tensão / Tension / Tension / Tension	V	230



MODELO / MODÈLE / MODELO / MODEL	UDMB45 PV	UDMB32 PV
CÓDIGO / CODE / CÓDIGO / CODE	2829.684	2829.681
<b>Preço/ Prix /Precio/ Price</b>	<b>€</b>	<b>368,00</b>
Dimensões / Dimensions / Dimensiones	mm	402x458x560
Volume / Volume / Volume / Volume	lt	32
Temperatura / Température / Temperatura / Température	°C	+8
Prateleiras / Étagère / Estante / Shelf	nr	2
Potência / Puissance / Potência / Power	W	65
Peso Líquido-Bruto /Poids Net-Brut /Peso Neto-Bruto /Net-Gross Weight	kg	12,30-14,20
Tensão / Tension / Tension / Tension	V	230



confirmar disponibilidade  
confirmer la disponibilité  
confirmar la disponibilidad  
confirm the availability





udi fri

**REFRIGERADORES BACK BAR - PORTA PIVOTANTE**

REFROIDISSEURS DE BOUTEILLES - PORTE PIVOTANTE

REFRIGERADORES DE BOTELLAS BAR - PUERTA PIVOTANTE

BACK BAR COOLERS - PIVOTING DOOR



Standard = Luz interior + Fechadura + Porta de Vidro (camada dupla de vidro temperado) + Display LED.  
 Standard = Lumière intérieure + Verrouillage + Porte en verre (double couche de verre) + LED display.  
 Standard = Luz interior + Cerradura + Puerta de vidrio (doble capa de vidrio) + Display LED.  
 Standard = Inside light + Lock + Glass Door (double layer of glass) + LED display.

**NOVO  
NOUVEAU  
NUEVO  
NEW**



MODELO / MODÈLE / MODELO / MODEL		UD141 PORTA PIVOTANTE	BA138H PORTA PIVOTANTE
CÓDIGO / CODE / CÓDIGO / CODE		2829.626	2929.302
<b>Preço / Prix / Precio / Price</b>	€	<b>820,00</b>	<b>820,00</b>
Dimensões / Dimensions / Dimensiones	mm	600X530X865	600x520x900
Volume / Volume / Volume / Volume	lt	105	133
Temperatura / Température / Temperatura / Temperature	°C	+0/+10	+2/+10
Prateleiras / Étagère / Estante / Shelf	nr	2	2
Gás refrigerante / Gaz réfrigérant / Gas refrigerante / Ref rig. gas		R600a	R600a
Refrigeração / Refrigeration / Refrigeracion / Cooling		V	V
Potência / Puissance / Potência / Power	W	120	180
Tensão / Tension / Tension / Tension	V	230	230



MODELO / MODÈLE / MODELO / MODEL		UD211 PV PORTAS PIVOTANTES	BA 208 H DISP ELECTRÓNICO 2 PORTAS PIVOTANTES
CÓDIGO / CODE / CÓDIGO / CODE		2829.628	2929.304
<b>Preço / Prix / Precio / Price</b>	€	<b>1.100,00</b>	<b>1.100,00</b>
Dimensões / Dimensions / Dimensiones	mm	900x530x865	900x520x900
Volume / Volume / Volume / Volume	lt	158	200
Temperatura / Température / Temperatura / Temperature	°C	0/+10	+2/+10
Prateleiras / Étagère / Estante / Shelf	nr	4	4
Gás refrigerante / Gaz réfrigérant / Gas refrigerante / Ref rig. gas		R600a	R600a
Refrigeração / Refrigeration / Refrigeracion / Cooling		V	V
Potência / Puissance / Potência / Power	W	160	230
Tensão / Tension / Tension / Tension	V	230	230

**NOVO  
NOUVEAU  
NUEVO  
NEW**



MODELO / MODÈLE / MODELO / MODEL		BA330H PORTAS PIVOTANTES
CÓDIGO / CODE / CÓDIGO / CODE		2929.312
<b>Preço / Prix / Precio / Price</b>	€	<b>1.394,00</b>
Dimensões / Dimensions / Dimensiones	mm	1350x520x900
Volume / Volume / Volume / Volume	lt	320
Temperatura / Température / Temperatura / Temperature	°C	-1/+6
Prateleiras / Étagère / Estante / Shelf	nr	6
Gás refrigerante / Gaz réfrigérant / Gas refrigerante / Ref rig. gas		R600a
Refrigeração / Refrigeration / Refrigeracion / Cooling		V
Potência / Puissance / Potência / Power	W	240
Tensão / Tension / Tension / Tension	V	230



MODELO / MODÈLE / MODELO / MODEL		UD209 PV PORTAS DESLIZANTES	BA 208 S DISP ELECTRÓNICO 2 PORTAS DESLIZANTES
CÓDIGO / CODE / CÓDIGO / CODE		2829.630	2929.306
<b>Preço / Prix / Precio / Price</b>	<b>€</b>	<b>1.140,00</b>	<b>1.140,00</b>
Dimensões / Dimensions / Dimensiones	mm	900x530x865	900x520x900
Volume / Volume / Volume / Volume	lt	158	200
Temperatura / Température / Temperatura / Temperature	°C	+2/+10	+2/+10
Prateleiras / Étagère / Estante / Shelf	nr	4	4
Gás refrigerante / Gaz réfrigérant / Gas refrigerante / Ref rig. gas		R600a	R600a
Refrigeração / Refrigeration / Refrigeracion / Cooling		V	V
Potência / Puissance / Potência / Power	W	160	160
Tensão / Tension / Tension / Tension	V	230	230



MODELO / MODÈLE / MODELO / MODEL		BA 3865 DISP ELECTRÓNICO 3 PORTAS DESLIZANTES
CÓDIGO / CODE / CÓDIGO / CODE		2929.309
<b>Preço / Prix / Precio / Price</b>	<b>€</b>	<b>1.390,00</b>
Dimensões / Dimensions / Dimensiones	mm	1335x500x860
Volume / Volume / Volume / Volume	lt	302
Temperatura / Température / Temperatura / Temperature	°C	+1/+9
Prateleiras / Étagère / Estante / Shelf	nr	6
Gás refrigerante / Gaz réfrigérant / Gas refrigerante / Ref rig. gas		R600a
Refrigeração / Refrigeration / Refrigeracion / Cooling		V
Potência / Puissance / Potência / Power	W	215
Tensão / Tension / Tension / Tension	V	230



MODELO / MODÈLE / MODELO / MODEL		BA330S DISP. ELECTRÓNICO 3 PORTAS DESLIZANTES	UD309 DISP. ELECTRÓNICO 3 PORTAS DESLIZANTES
CÓDIGO / CODE / CÓDIGO / CODE		2929.310	2829.632
<b>Preço / Prix / Precio / Price</b>	<b>€</b>	<b>1.390,00</b>	<b>1.390,00</b>
Dimensões / Dimensions / Dimensiones	mm	1350x520x900	1350x520x865
Volume / Volume / Volume / Volume	lt	350	308
Temperatura / Température / Temperatura / Temperature	°C	-1/+6	+2/+10
Prateleiras / Étagère / Estante / Shelf	nr	6	6
Gás refrigerante / Gaz réfrigérant / Gas refrigerante / Ref rig. gas		R600a	R600a
Refrigeração / Refrigeration / Refrigeracion / Cooling		V	V
Potência / Puissance / Potência / Power	W	350	160
Tensão / Tension / Tension / Tension	V	230	230



UDIfri





Cave de vinho com 2 zonas de temperatura. Design elegante com porta de aço inoxidável. Ajuste de temperatura de 5°C a 18°C. Sistema termodinâmico. Porta de vidro com tratamento anti-UV. Exibição eletrônica de temperatura. Controle digital. Iluminação LED com interruptor. Tecnologia silenciosa. Sistema antivibração. Pés ajustáveis.



Cave à vin avec 2 zones de température. Design élégant avec porte en acier inoxydable. Réglage de la température de 5°C à 18°C. Système thermodynamique. Porte vitrée avec traitement anti-UV. Affichage électronique de la température. Contrôle numérique. Éclairage LED avec interrupteur. Technologie silencieuse. Système anti-vibration. Pieds réglables.



Vinoteca con 2 zonas de temperatura. Diseño elegante con puerta de acero inoxidable. Ajuste de temperatura de 5°C a 18°C. Sistema termodinámico. Puerta de cristal con tratamiento anti-UV. Pantalla electrónica de temperatura. controles digitales Iluminación LED con interruptor. Tecnología silenciosa. Sistema antivibración. Pies ajustables.



Wine cellar with 2 temperature zones. Elegant design with stainless steel door. Temperature setting from 5°C to 18°C. Thermodynamic system. Glass door with anti-UV treatment. Electronic temperature display. Digital control. LED lighting with switch. Silent technology. Anti-vibration system. Adjustable feet.



**NOVO**  
**NOUVEAU**  
**NUEVO**  
**NEW**



MODELO / MODÈLE / MODELO / MODEL	CAVE VINHO DUAS ZONAS 32 GARRAFAS	
CÓDIGO / CODE / CÓDIGO / CODE	2230.904	
<b>Preço / Prix / Precio / Price</b>	€	<b>900,00</b>
Dimensões / Dimensions / Dimensiones	mm	480x430x850
Capacidade de Garrafas / Capacité Bouteilles / Capacidad Botellas / Bottles Capacity	nr	32
Volume / Volume / Volume / Volume	lt	80
Temperatura / Température / Temperatura / Temperature	°C	+5/+18
Prateleiras / Étagère / Gâtante / Shelf	nr	3
Peso Líquido-Bruto / Poids Net-Brut / Peso Neto-Bruto / Net-Gross Weight	kg	27,4-30,8
Tensão / Tension / Tension / Tension	V	230

**NOVO**  
**NOUVEAU**  
**NUEVO**  
**NEW**



MODELO / MODÈLE / MODELO / MODEL	CAVE VINHO DUAS ZONAS 62 GARRAFAS	
CÓDIGO / CODE / CÓDIGO / CODE	2230.906	
<b>Preço / Prix / Precio / Price</b>	€	<b>1.191,00</b>
Dimensões / Dimensions / Dimensiones	mm	550x560x840
Capacidade de Garrafas / Capacité Bouteilles / Capacidad Botellas / Bottles Capacity	nr	62
Volume / Volume / Volume / Volume	lt	138
Temperatura / Température / Temperatura / Temperature	°C	+5/+18
Prateleiras / Étagère / Gâtante / Shelf	nr	3
Peso Líquido-Bruto / Poids Net-Brut / Peso Neto-Bruto / Net-Gross Weight	kg	34,1-38,4
Tensão / Tension / Tension / Tension	V	230

**NOVO**  
**NOUVEAU**  
**NUEVO**  
**NEW**



MODELO / MODÈLE / MODELO / MODEL	CAVE VINHO DUAS ZONAS 91 GARRAFAS	
CÓDIGO / CODE / CÓDIGO / CODE	2230.908	
<b>Preço / Prix / Precio / Price</b>	€	<b>1.629,00</b>
Dimensões / Dimensions / Dimensiones	mm	540x550x1238
Capacidade de Garrafas / Capacité Bouteilles / Capacidad Botellas / Bottles Capacity	nr	91
Volume / Volume / Volume / Volume	lt	204
Temperatura / Température / Temperatura / Temperature	°C	+5/+18
Prateleiras / Étagère / Gâtante / Shelf	nr	5
Peso Líquido-Bruto / Poids Net-Brut / Peso Neto-Bruto / Net-Gross Weight	kg	51,9 - 60,9
Tensão / Tension / Tension / Tension	V	230



UDIfri

CAVES DE VINHO  
CAVES A VINS  
BODEGAS DE VINOS  
WINE CELLARS



Caves de Vinho de 2 e 3 compartimentos  
Display eletrónico LED  
Porta e puxador em aço inox  
Refrigeração ventilada  
Iluminação LED  
Fechadura  
Côr Preta



Caves a Vins de 2 et 3 compartiments  
LED d'affichage électronique  
Porte et poignée en acier inoxydable  
Réfrigération ventilée  
Éclairage LED  
Serrure  
Couleur Noir



Bodegas de Vinos de 2 y 3  
compartimentos  
Pantalla electrónica de LED  
Puerta y mango de acero inoxidable  
Refrigeración por aire forzado  
Iluminación LED  
Bloqueo  
Color Negro



Wine Cellars with 2 and 3 compartments  
Electronic display LED  
Door and stainless steel handle  
Forced air refrigeration  
Led lightning  
Door lock  
Black color



2 Zonas de  
Temperatura



MODELO / MODÈLE / MODELO / MODEL		UDAC208
CÓDIGO / CODE / CÓDIGO / CODE		2829.610
<b>Preço / Prix / Precio / Price</b>	<b>€</b>	<b>1.559,00</b>
Dimensões / Dimensions / Dimensiones	mm	595x573x865
Capacidade de Garrafas / Capacité Bouteilles / Capacidad Botellas / Bottles Capacity	nr	2x19
Volume / Volume / Volume / Volume	lt	119
Temperatura / Température / Temperatura / Temperature	°C	(+5/+18)
Prateleiras / Étagère / Gâtante / Shelf	nr	10+2
Refrigeração / Refrigeration / Refrigeracion / Cooling		V
Consumo energia / Consommation d'énergie / Cons.Energia / Energy Cons.	kWh/24h	0,389
Tensão / Tension / Tension / Tension	V	230

2 Zonas de  
Temperatura



MODELO / MODÈLE / MODELO / MODEL		UDCV902
CÓDIGO / CODE / CÓDIGO / CODE		2829.614
<b>Preço / Prix / Precio / Price</b>	<b>€</b>	<b>2.670,00</b>
Dimensões / Dimensions / Dimensiones	mm	595x677x 1390
Capacidade de Garrafas / Capacité Bouteilles / Capacidad Botellas / Bottles Capacity	nr	55+55
Volume / Volume / Volume / Volume	lt	312
Temperatura / Température / Temperatura / Temperature	°C	(+5/+10) - (+10/+18)
Prateleiras / Étagère / Gâtante / Shelf	nr	9,5
Consumo energia / Consommation d'énergie / Cons.Energia / Energy Cons.	kWh/24h	0,87
Tensão / Tension / Tension / Tension	V	230





Caves de Vinho de 2 e 3 compartimentos  
Display eletrónico LED  
Porta e puxador em aço inox  
Refrigeração ventilada  
Iluminação LED  
Fechadura  
Côr Preta



Caves a Vins de 2 et 3 compartiments  
LED d'affichage électronique  
Porte et poignée en acier inoxydable  
Réfrigération ventilée  
Éclairage LED  
Serrure  
Couleur Noir



Bodegas de Vinos de 2 y 3  
compartimentos  
Pantalla electrónica de LED  
Puerta y mango de acero inoxidable  
Refrigeración por aire forzado  
Iluminación LED  
Bloqueo  
Color Negro



Wine Cellars with 2 and 3 compartments  
Electronic display LED  
Door and stainless steel handle  
Forced air refrigeration  
Led lightning  
Door lock  
Black color



**2** Zonas de  
Temperatura



MODELO / MODÈLE / MODELO / MODEL	UDCV922	
CÓDIGO / CODE / CÓDIGO / CODE	2829.616	
<b>Preço / Prix / Precio / Price</b>	€	<b>3.017,00</b>
Dimensões / Dimensions / Dimensiones	mm	595x677x 1762
Capacidade de Garrafas / Capacité Bouteilles / Capacidad Botellas / Bottles Capacity	nr	77+77
Volume / Volume / Volume / Volume	lt	416
Temperatura / Température / Temperatura / Temperature	°C	(+5/+10) - (+10/+18)
Prateleiras / Étagère / Gâtante / Shelf	nr	7+1/2
Consumo energia / Consommation d'énergie / Cons.Energia /Energy Cons.	kWh/24h	0,92
Tensão / Tension / Tension / Tension	V	230

**2** Zonas de  
Temperatura



**NOVO**  
**NOUVEAU**  
**NUEVO**  
**NEW**

MODELO / MODÈLE / MODELO / MODEL	UDCV1248	
CÓDIGO / CODE / CÓDIGO / CODE	2829.617	
<b>Preço / Prix / Precio / Price</b>	€	<b>3.112,00</b>
Dimensões / Dimensions / Dimensiones	mm	595x680x 1764
Capacidade de Garrafas / Capacité Bouteilles / Capacidad Botellas / Bottles Capacity	nr	126x75cl
Volume / Volume / Volume / Volume	lt	416
Temperatura / Température / Temperatura / Temperature	°C	(+5/+10) - (+10/+18)
Prateleiras / Étagère / Gâtante / Shelf	nr	7 + 1/2
Refrigeração / Refrigeration / Refrigeracion / Cooling	V	
Consumo energia / Consommation d'énergie / Cons.Energia /Energy Cons.	kWh/24h	0,479
Tensão / Tension / Tension / Tension	V	230

**3** Zonas de  
Temperatura



MODELO / MODÈLE / MODELO / MODEL	UDCV933	
CÓDIGO / CODE / CÓDIGO / CODE	2829.618	
<b>Preço / Prix / Precio / Price</b>	€	<b>3.240,00</b>
Dimensões / Dimensions / Dimensiones	mm	595x677x 1762
Capacidade de Garrafas / Capacité Bouteilles / Capacidad Botellas / Bottles Capacity	nr	44+45+44
Volume / Volume / Volume / Volume	lt	404
Temperatura / Température / Temperatura / Temperature	°C	(+5/+18) - (+5/+10) - (+10/+18)
Prateleiras / Étagère / Gâtante / Shelf	nr	5+5+3,5
Consumo energia / Consommation d'énergie / Cons.Energia /Energy Cons.	kWh/24h	0,91
Tensão / Tension / Tension / Tension	V	230



confirmar disponibilidade  
confirmer la disponibilité  
confirmar la disponibilidad  
confirm the availability



UDIfri

CAVES DE VINHO  
CAVES A VINS  
BODEGAS DE VINOS  
WINE CELLARS



LUX - Dual digital  
2 termostatos sob consulta



LUX - Dual digital  
2 thermostats sur demande



LUX - Dual digital  
2 termostatos a petición



LUX - Dual digital  
2 thermostats on request



Cap. 102 + 25



PRATELEIRA  
MADEIRA  
WOOD SHELF

2828.888

87,00



MODELO / MODÈLE / MODELO / MODEL

UDCV380

CÓDIGO / CODE / CÓDIGO / CODE

2828.886

<b>Preço / Prix / Precio / Price</b>	€	<b>1.067,00</b>
Dimensões / Dimensions / Dimensiones	mm	595x640x1840
Volume / Volume / Volume / Volume	Lt	372
Temperatura / Température / Temperatura / Temperature	°C	+5/+18
Prateleiras / Étagère / Gâtante / Shelf	nr	5
Gás refrigerante / Gaz réfrigérant / Gas refrigerante / Refrig. gas		R600a
Peso Líquido / Poids Net / Peso Neto / Net Weight	kg	74
Potência / Puissance / Potência / Power	W	300
Tensão / Tension / Tension / Tension	V	230

MODELO / MODÈLE / MODELO / MODEL

UCV125BLE PV

CÓDIGO / CODE / CÓDIGO / CODE

2828.770

<b>Preço / Prix / Precio / Price</b>	€	<b>541,00</b>
Dimensões / Dimensions / Dimensiones	mm	526x535x 840
Volume / Volume / Volume / Volume	Lt	123
Temperatura / Température / Temperatura / Temperature	°C	+6/+14
Prateleiras / Étagère / Gâtante / Shelf	nr	4
Gás refrigerante / Gaz réfrigérant / Gas refrigerante / Refrig. gas		R134A
Peso Líquido / Poids Net / Peso Neto / Net Weight	kg	43
Potência / Puissance / Potência / Power	W	87
Tensão / Tension / Tension / Tension	V	230

MODELO / MODÈLE / MODELO / MODEL

LUX 110G 2 TERM  
80 GARRAFAS

CÓDIGO / CODE / CÓDIGO / CODE

2828.987

<b>Preço / Prix / Precio / Price</b>	€	<b>824,00</b>
Dimensões / Dimensions / Dimensiones	mm	595x600x 1240
Volume / Volume / Volume / Volume	Lt	188
Temperatura / Température / Temperatura / Temperature	°C	+12/+22 +5/+15
Prateleiras / Étagère / Gâtante / Shelf	nr	3
Gás refrigerante / Gaz réfrigérant / Gas refrigerante / Refrig. gas		R134A
Peso Líquido / Poids Net / Peso Neto / Net Weight	kg	74
Potência / Puissance / Potência / Power	W	137
Tensão / Tension / Tension / Tension	V	230



confirmar disponibilidade  
confirmer la disponibilité  
confirmar la disponibilidad  
confirm the availability

\* Display + LED interior + Vidro temperado + Porta revestida a aço inox  
Display + LED d'intérieur + Verre trempé + Porte revêtu en acier inoxydable  
Display + LED de interior + Vidrio templado + Puerta recubierta de acero inoxidable  
Display + Indoor LED + Tempered glass + Door coated in stainless steel



Cave de vinho fabricada em chapa pintada a preto com tratamento anti-corrosão e interior ABS.  
Refrigeração ventilada.  
Porta de vidro com fechadura e chave, reversível, sem moldura.  
Com filtro de carbono-ativo, baixa emissão de infra-vermelhos e ultravioleta que passa através do vidro sem minimizar a quantidade de luz para o interior.  
Termostato eletrónico.  
Iluminação LED.



Cave à vin en tôle peinte en noir avec traitement anti-corrosion et intérieur en ABS.  
Étagères en bois amovibles.  
Refrédissement ventilé.  
Porte vitrée avec serrure et clé, réversible, sans cadre.  
Avec filtre à charbon actif, faible émission infrarouge et ultraviolette qui traverse le verre sans minimiser la quantité de lumière à l'intérieur.  
Thermostat électronique.  
Éclairage LED.



Vinoteca fabricada en chapa pintada en negro con tratamiento anticorrosión e interior en ABS.  
Estantes en madeira desmontables.  
Refrigeración ventilada.  
Puerta de cristal con cerradura y llave, reversible sin marco.  
Con filtro de carbón activo, baja emisión de infrarrojos y ultravioleta que atraviesa el cristal sin minimizar la cantidad de luz al interior.  
Termostato electrónico.  
Iluminación LED.



Wine cellar made of black painted sheet metal with anti-corrosion treatment and ABS interior.  
Removable wooden sheves.  
Ventilated cooling.  
Frameless reversible glass door with lock.  
With an active carbon filter, low emission of infrared and ultraviolet that passes through the glass, without minimizing the amount of light to the interior.  
Electronic thermostat.  
LED lightning.

**NOVO**  
NOUVEAU  
NUEVO  
NEW



MODELO / MODÈLE / MODELO / MODEL	UDCW 37 G2TB	
CÓDIGO / CODE / CÓDIGO / CODE	2829.929	
<b>Preço / Prix / Precio / Price</b>	€	<b>1.024,00</b>
Dimensões / Dimensions / Dimensiones	mm	380x573x820
Capacidade de Garrafas / Capacité Bouteilles / Capacidad Botellas / Bottles Capacity	nr	28
Volume / Volume / Volume / Volume	lt	86
Temperatura / Température / Temperatura / Temperature	°C	+2/+12 - +12/+20
Prateleiras / Étagère / Gâtante / Shelf	nr	5 (447x297) 1 (308x288)
Consumo energia / Consommation d'énergie / Cons.Energia /Energy Cons.	kWh/24h	0,39
Tensão / Tension / Tension / Tension	V	230

**NOVO**  
NOUVEAU  
NUEVO  
NEW



MODELO / MODÈLE / MODELO / MODEL	UDCW 46 G2TB	
CÓDIGO / CODE / CÓDIGO / CODE	2829.930	
<b>Preço / Prix / Precio / Price</b>	€	<b>1.404,00</b>
Dimensões / Dimensions / Dimensiones	mm	595x573x820
Capacidade de Garrafas / Capacité Bouteilles / Capacidad Botellas / Bottles Capacity	nr	46
Volume / Volume / Volume / Volume	lt	148
Temperatura / Température / Temperatura / Temperature	°C	+2/+12 - +12/+20
Prateleiras / Étagère / Gâtante / Shelf	nr	5 (447x492) 1 (292x492)
Consumo energia / Consommation d'énergie / Cons.Energia /Energy Cons.	kWh/24h	0,42
Tensão / Tension / Tension / Tension	V	230

**NOVO**  
NOUVEAU  
NUEVO  
NEW



MODELO / MODÈLE / MODELO / MODEL	UDCW 120 G2TB	
CÓDIGO / CODE / CÓDIGO / CODE	2829.935	
<b>Preço / Prix / Precio / Price</b>	€	<b>2.167,00</b>
Dimensões / Dimensions / Dimensiones	mm	595x690x1200
Capacidade de Garrafas / Capacité Bouteilles / Capacidad Botellas / Bottles Capacity	nr (0,75cl)	56
Volume / Volume / Volume / Volume	lt	270
Temperatura / Température / Temperatura / Temperature	°C	+2/+12 - +12/+20
Prateleiras / Étagère / Gâtante / Shelf	nr	4 (452x535) 1 (452x380)
Consumo energia / Consommation d'énergie / Cons.Energia /Energy Cons.	kWh/24h	0,65
Tensão / Tension / Tension / Tension	V	230

**NOVO**  
NOUVEAU  
NUEVO  
NEW

**NOVO**  
NOUVEAU  
NUEVO  
NEW



MODELO / MODÈLE / MODELO / MODEL	UDCW 160 G1TB	UDCW 160 G2TB	
CÓDIGO / CODE / CÓDIGO / CODE	2829.937	2829.938	
<b>Preço / Prix / Precio / Price</b>	€	<b>2.619,00</b>	<b>2.673,00</b>
Dimensões / Dimensions / Dimensiones	mm	595x690x1600	595x690x1600
Capacidade de Garrafas / Capacité Bouteilles / Capacidad Botellas / Bottles Capacity	nr (0,75cl)	116	104
Volume / Volume / Volume / Volume	lt	386	382
Temperatura / Température / Temperatura / Temperature	°C	+2/+20	+2/+12 - +12/+20
Prateleiras / Étagère / Gâtante / Shelf	nr	9 (452x535) 1 (452x380)	8 (452x535) 1 (452x380)
Consumo energia / Consommation d'énergie / Cons.Energia /Energy Cons.	kWh/24h	0,49	0,49
Tensão / Tension / Tension / Tension	V	230	230





CLIMATEX



CAVES DE VINHO  
CAVES A VINS  
BODEGAS DE VINOS  
WINE CELLARS



NOVO  
NOUVEAU  
NUEVO  
NEW



NOVO  
NOUVEAU  
NUEVO  
NEW



MODELO / MODÈLE / MODELO / MODEL		UDCW 180 G1TB	UDCW 180 G2TB
CÓDIGO / CODE / CÓDIGO / CODE		2829.939	2829.940
<b>Preço / Prix / Precio / Price</b>	€	<b>3.059,00</b>	<b>3.120,00</b>
Dimensões / Dimensions / Dimensiones	mm	595x690x1800	595x690x1800
Capacidade de Garrafas / Capacité Bouteilles / Capacidad Botellas / Bottles Capacity	nr (0,75cl)	128	116
Volume / Volume / Volume / Volume	lt	438	434
Temperatura / Température / Temperatura / Temperature	°C	+2/+20	+2/+12 - +12/+20
Prateleiras / Étagère / Gâtante / Shelf	nr	10 (452x535) 1 (452x380)	9 (452x535) 1 (452x380)
Consumo energia / Consommation d'énergie / Cons.Energia /Energy Cons.	kWh/24h	0,5	0,5
Tensão / Tension / Tension / Tension	V	230	230

NOVO  
NOUVEAU  
NUEVO  
NEW



MODELO / MODÈLE / MODELO / MODEL		UDCW 355 G3TB
CÓDIGO / CODE / CÓDIGO / CODE		2829.950
<b>Preço / Prix / Precio / Price</b>	€	<b>6.432,00</b>
Dimensões / Dimensions / Dimensiones	mm	1210 x 690 x 1800
Capacidade de Garrafas / Capacité Bouteilles / Capacidad Botellas / Bottles Capacity	nr (0,75cl)	244
Volume / Volume / Volume / Volume	lt	872
Temperatura / Température / Temperatura / Temperature	°C	+2/+12 - +12/+20 - +2/+20
Prateleiras / Étagère / Gâtante / Shelf	nr	19 (452x535) 2 (452x380)
Consumo energia / Consommation d'énergie / Cons.Energia /Energy Cons.	kWh/24h	1
Tensão / Tension / Tension / Tension	V	230

NOVO  
NOUVEAU  
NUEVO  
NEW



NOVO  
NOUVEAU  
NUEVO  
NEW



## MODELO SLIM

MODELO / MODÈLE / MODELO / MODEL		UDDW 170 1T	UDDW 170 2T
CÓDIGO / CODE / CÓDIGO / CODE		2829.942	2829.944
<b>Preço / Prix / Precio / Price</b>	€	<b>2.551,00</b>	<b>2.635,00</b>
Dimensões / Dimensions / Dimensiones	mm	595x550x1790	595x550x1790
Capacidade de Garrafas / Capacité Bouteilles / Capacidad Botellas / Bottles Capacity	nr (0,75cl)	112	110
Volume / Volume / Volume / Volume	lt	318	318
Temperatura / Température / Temperatura / Temperature	°C	+2/+20	+2/+12 - +12/+20
Prateleiras / Étagère / Gâtante / Shelf	nr	15 (491x410) 1 (493x240)	14 (491x410) 1 (493x240)
Consumo energia / Consommation d'énergie / Cons.Energia /Energy Cons.	kWh/24h	0,49	0,512
Tensão / Tension / Tension / Tension	V	230	230

NOVO  
NOUVEAU  
NUEVO  
NEW



NOVO  
NOUVEAU  
NUEVO  
NEW



MODELO / MODÈLE / MODELO / MODEL		SLIM WINE UDSW 112 1TB	SLIM WINE UDSW 105 2TB
CÓDIGO / CODE / CÓDIGO / CODE		2829.946	2829.948
<b>Preço / Prix / Precio / Price</b>	€	<b>2.540,00</b>	<b>2.603,00</b>
Dimensões / Dimensions / Dimensiones	mm	450x690x1800	450x690x1800
Capacidade de Garrafas / Capacité Bouteilles / Capacidad Botellas / Bottles Capacity	nr (0,75cl)	112	105
Volume / Volume / Volume / Volume	lt	385	385
Temperatura / Température / Temperatura / Temperature	°C	+2/+20	+2/+12 - +12/+20
Prateleiras / Étagère / Gâtante / Shelf	nr	15 (324x555) 1 (345x380)	14 (324x555) 1 (345x380)
Consumo energia / Consommation d'énergie / Cons.Energia /Energy Cons.	kWh/24h	0,75	0,78
Tensão / Tension / Tension / Tension	V	230	230



Aço inoxidável.  
 Período de conservação do vinho 3/4 semanas.  
 Compressor silencioso com degelo automático.  
 Dose ajustável. Configuração padrão 75 ml.  
 Termostato eletrónico.



Acier inoxydable.  
 Durée de conservation du vin 3/4 semaines.  
 Compresseur silencieux avec dégivrage automatique.  
 Dose réglable. Réglage par défaut 75 ml.  
 Thermostat électronique.



Acero inoxidable.  
 Período de almacenamiento del vino 3 / 4 semanas.  
 Compresor silencioso con descongelación automática.  
 Dosis regulable. Configuración estándar 75 ml.  
 Termostato electrónico.



Stainless Steel.  
 Wine storage period 3 / 4 weeks.  
 Silent compressor with automatic defrost.  
 Adjustable dose. Default setting 75 ml.  
 Electronic thermostat.



**NOVO**  
**NOUVEAU**  
**NUEVO**  
**NEW**



MODELO / MODÈLE / MODELO / MODEL	UDSOMMELIER 4	
CÓDIGO / CODE / CÓDIGO / CODE		2829.962
<b>Preço / Prix / Precio / Price</b>	€	<b>3.066,00</b>
Dimensões / Dimensions / Dimensiones / Dimensions	mm	650x325x610
Temperatura / Température / Temperatura / Temperature	°C	+4/+18
Iluminação / Éclairage / Iluminación / Lighting		LED
Gás refrigerante / Gaz réfrigérant / Gas refrigerante / Cooling gas		R600A
Peso Líquido-Bruto / Poids Net-Brut / Peso Neto-Bruto / Net-Gross Weight	kg	40-43
Potência / Puissance / Potência / Power	W	95
Tensão / Tension / Tension / Tension	V	230

**NOVO**  
**NOUVEAU**  
**NUEVO**  
**NEW**

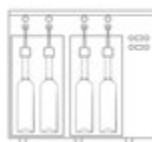

MODELO / MODÈLE / MODELO / MODEL	UDSOMMELIER 6	
CÓDIGO / CODE / CÓDIGO / CODE		2829.964
<b>Preço / Prix / Precio / Price</b>	€	<b>4.467,00</b>
Dimensões / Dimensions / Dimensiones / Dimensions	mm	845x380x641
Temperatura / Température / Temperatura / Temperature	°C	+4/+18
Iluminação / Éclairage / Iluminación / Lighting		LED
Gás refrigerante / Gaz réfrigérant / Gas refrigerante / Cooling gas		R600A
Peso Líquido-Bruto / Poids Net-Brut / Peso Neto-Bruto / Net-Gross Weight	kg	51-55
Potência / Puissance / Potência / Power	W	100
Tensão / Tension / Tension / Tension	V	230

**SOMMELIER 4**

POSICIONAMENTO BOMBA AZOTO  
 NITROGEN TANK POSITIONING



UDIfri

**TIRADOR DE CERVEJAS**  
TIREUR DE BIÈRE  
EXTRACTOR DE CERVEZAS  
BEER DISPENSER



Surpreenda seus amigos com o sabor de uma autêntica cerveja de pressão. Descubra o prazer de um dispensador de cerveja. Compatível com todos os barris universais de 5L, este dispositivo garante uma vida útil da cerveja de até 30 dias. Equipado com uma alça destacável e corpo em aço inoxidável, o dispensador funciona com barris de 5 litros. O seu sistema de refrigeração integrado permite-lhe desfrutar da sua cerveja à temperatura ideal. Ajuste a temperatura de acordo com suas necessidades, seja 6°C para cerveja aromatizada ou 11°C para cerveja preta. Com um simples gesto, redescubra o sabor único de um dispensador de cerveja cervejeira.



Surprenez vos amis avec le goût d'une authentique bière céd. Découvrez le plaisir d'un distributeur de bière. Compatible avec tous les fûts universels de 5L, cet appareil garantit une durée de vie de la bière allant jusqu'à 30 jours. Équipé d'une poignée détachable et d'un corps en acier inoxydable, le distributeur fonctionne avec des barils de 5 litres. Son système de refroidissement intégré vous permet de profiter de votre bière à la température idéale. Ajustez la température selon vos besoins, soit 6°C pour la bière aromatisée ou 11°C pour la bière noire. D'un simple geste, redécouvrez le goût unique d'un distributeur de bière brassée.



Sorprende a tus amigos con el sabor de una auténtica cerveza de presión. Descubre el placer de un dispensador de cerveza de barril. Compatible con todos los barriles universales de 5L, este dispositivo garantiza una vida útil de la cerveza de hasta 30 días. Equipado con un mango desmontable y un cuerpo de acero inoxidable, el dispensador funciona con barriles de 5 litros. Su sistema de refrigeración integrado te permite disfrutar de tu cerveza a una temperatura ideal. Ajuste la temperatura según sus necesidades, ya sea 6 °C para cerveza de sabores o 11 °C para cerveza negra. Con un simple gesto, redescubra el sabor único de un dispensador de cerveza de cervcería.



Surprise your friends with the taste of an authentic céd beer. Discover the pleasure of a beer dispenser. Compatible with all 5L universal barrels, this device guarantees a beer life of up to 30 days. Equipped with a detachable handle and stainless steel body, the dispenser works with 5-liter barrels. Its built-in cooling system allows you to enjoy your beer at the ideal temperature. Adjust the temperature according to your needs, either 6°C for flavored beer or 11°C for black beer. With a simple gesture, rediscover the unique taste of a brewing beer dispenser.

**NOVO  
NOUVEAU  
NUEVO  
NEW**



MODELO / MODÈLE / MODELO / MODEL  
CÓDIGO / CODE / CÓDIGO / CODE

TIRADOR DE CERVEJA INOX 5L  
2230.902

Preço / Prix / Precio / Price	€	336,00
Dimensões / Dimensions / Dimensiones	mm	280x370x440
Temperatura / Température / Temperatura / Temperature	°C	+2/+12
Peso Líquido-Bruto / Poids Net-Brut / Peso Neto-Bruto / Net-Gross Weight	kg	6-7,85
Tensão / Tension / Tension / Tension	V	230



ALFA - Exterior em chapa galvanizada revestida a PVC cinza. Interior revestido em PVC atóxico. Tampas de correr em aço inox.  
UDI CIRCULAR - Capacidade para 8 garrafas; Grande visibilidade da marca do produto, com visão de 360°; temperatura regulável à necessidade do produto.



ALFA - Extérieur en tôle galvanisé revêtu a PVC Gris. Intérieur revêtu a PVC atóxico. Couverts glissière en acier inox.  
UDI CIRCULAIRE - Capacité de 8 bouteilles; Grande visibilité de la marque du produit, avec vue à 360 degrés; Température réglable à la nécessité pour le type de produit.



ALFA - Exterior en chapa galvanizada revestida en PVC Gris. Interior revestido a PVC atóxico. Tapas de correr en acero inox.  
UDI CIRCULAR - Capacidad para 8 botellas, Gran visibilidad de la marca del producto, con vista de 360 grados; Ajustable a la necesidad de la temperatura del producto.



Outside finishing made of galvanized sheet covered with PVC Grey. Inside finishing made of atoxic PVC. Stainless steel hinged lid.  
UDI CIRCULAR - Capacity for 8 bottles; Great visibility of the brand of the product, with vision of 360°; Temperature adjustable to the need for the type of the product.



MODELO/MODÈLE/MODELO/MODEL	UDI CIRCULAR	
CÓDIGO / CODE / CÓDIGO / CODE	3097.300	
<b>Preço / Prix / Precio / Price</b>	<b>€</b>	<b>1.093,00</b>
Dimensões / Dimensions / Dimensiones	(LxPxA) mm	435x435x370
Temperaturas / Températures / Temperaturas / Temperature	°C	+4/+15
Potência / Puissance / Potencia / Power	W	160
Tensão / Tension / Tensión / Tension	V/Hz	230



MODELO/MODÈLE/MODELO/MODEL	ALFA 1100	
CÓDIGO / CODE / CÓDIGO / CODE	2098.810	
<b>Preço / Prix / Precio / Price</b>	<b>€</b>	<b>1.053,00</b>
Dimensões / Dimensions / Dimensiones	(LxPxA) mm	1100x600x820
Temperaturas / Températures / Temperaturas / Temperature	°C	0/+8
Volume / Volume / Volumen / Volume	L	281
Grelhas / Étagères / Estantes / Shelves	nr	2/2
Peso bruto-líquido/ Poids brut-net/ Peso bruto-neto/ Gross-net weight	Kg	56/48
Potência / Puissance / Potencia / Power	W	211
Tensão / Tension / Tensión / Tension	V/Hz	230

MODELO/MODÈLE/MODELO/MODEL	ALFA 1400	
CÓDIGO / CODE / CÓDIGO / CODE	2098.815	
<b>Preço / Prix / Precio / Price</b>	<b>€</b>	<b>1.517,00</b>
Dimensões / Dimensions / Dimensiones	(LxPxA) mm	1410x600x820
Temperaturas / Températures / Temperaturas / Temperature	°C	0/+8
Volume / Volume / Volumen / Volume	L	380
Grelhas / Étagères / Estantes / Shelves	nr	2/4
Peso bruto-líquido/ Poids brut-net/ Peso bruto-neto/ Gross-net weight	Kg	62/51
Potência / Puissance / Potencia / Power	W	258
Tensão / Tension / Tensión / Tension	V/Hz	230



MODELO/MODÈLE/MODELO/MODEL	ALFA 1800	
CÓDIGO / CODE / CÓDIGO / CODE	2098.820	
<b>Preço / Prix / Precio / Price</b>	<b>€</b>	<b>1.652,00</b>
Dimensões / Dimensions / Dimensiones	(LxPxA) mm	1810x600x820
Temperaturas / Températures / Temperaturas / Temperature	°C	0/+8
Volume / Volume / Volumen / Volume	L	508
Grelhas / Étagères / Estantes / Shelves	nr	3/5
Peso bruto-líquido/ Poids brut-net/ Peso bruto-neto/ Gross-net weight	Kg	72/61
Potência / Puissance / Potencia / Power	W	292
Tensão / Tension / Tensión / Tension	V/Hz	230



UDIfri

## ARCAS CONGELADORAS - TAMPA OPACA DE LEVANTAR

CONGELATEURS BAHUTS - COUVERCLE DE LEVÉE OPAQUE

CONGELADORES - TAPA DE LEVANTAR OPACA

FREEZERS - OPAQUE RISING LID



Cuba exterior em chapa zincada  
plastificada a branco Cuba interior em  
alumínio



Cuve extérieure en tôle galvanisée laminée  
en blanc  
Cuve intérieure en aluminium



Cuba exterior em chapa zincada  
plastificada a branco.  
Cuba interior em alumínio



White plastified external zinc plate.  
Internal finishing in aluminium.



MODELO / MODÈLE / MODELO / MODEL	FRI ACHPA-130	
CÓDIGO / CODE / CÓDIGO / CODE	2828.593	
<b>Preço / Prix / Precio / Price</b>	<b>€</b>	<b>498,00</b>
Dimensões / Dimensions / Dimensiones	mm	540X 600X 850
Volume Útil / Volume Net / Volume Neto / Net Volume	lt	110
Temperatura / Température / Temperatura / Temperature	°C	-18/-23
Descongelação / Décongélation / Descong. / Defrosting	M/A	M
Refrigeração / Refrigeration / Refrigeracion / Cooling	S/V	S
Cestos / Paniers / Cestos / Baskets	nr	1
Peso Líquido-Bruto / Poids Net-Brut / Peso Neto-Bruto / Net-Gross Weight	kg	35/37
Potência / Puissance / Potência / Power	W	92
Tensão / Tension / Tension / Tension	V	230



MODELO / MODÈLE / MODELO / MODEL	FRI 2 CHPA-320	FRI 3 CHPA-420	FRI 5 CHPA-620	
CÓDIGO / CODE / CÓDIGO / CODE	2828.596	2828.597	2828.598	
<b>Preço / Prix / Precio / Price</b>	<b>€</b>	<b>656,00</b>	<b>744,00</b>	<b>980,00</b>
Dimensões / Dimensions / Dimensiones	mm	1040X 600X 850	1270X 600X 850	1600X 600X 850
Volume Útil / Volume Net / Volume Neto / Net Volume	lt	284	365	473
Temperatura / Température / Temperatura / Temperature	°C	-18/-23	-18/-23	-18/-23
Descongelação / Décongélation / Descong. / Defrosting	M/A	M	M	M
Refrigeração / Refrigeration / Refrigeracion / Cooling	S/V	S	S	S
Cestos / Paniers / Cestos / Baskets	nr	1	2	2
Peso Líquido-Bruto / Poids Net-Brut / Peso Neto-Bruto / Net-Gross Weight	kg	55/59	67/71	77/83
Potência / Puissance / Potência / Power	W	200	225	290
Tensão / Tension / Tension / Tension	V	230	230	230



confirmar disponibilidade  
confirmar la disponibilité  
confirmar la disponibilidad  
confirm the availability

M - Manual / A - Auto | V = Ventilada / Ventilé / Ventilada /  
Ventilated | S = Estática / Static / Estática / Static

Cestos incluídos / Paniers inclus / Cestas incluidas /  
Baskets included



**NOVO  
NOUVEAU  
NUEVO  
NEW**

MODELO / MODÈLE / MODELO / MODEL	ARCA HORIZONTAL 330LTS	
CÓDIGO / CODE / CÓDIGO / CODE	2828.926	
<b>Preço / Prix / Precio / Price</b>	<b>€</b>	<b>877,00</b>
Dimensões / Dimensions / Dimensiones	mm	1284x700x895
Volume Útil / Volume Net / Volume Neto / Net Volume	lt	330
Temperatura / Température / Temperatura / Temperature	°C	-15/-25
Refrigeração / Refrigeration / Refrigeracion / Cooling	Eletrónica	
Cestos / Paniers / Cestos / Baskets	nr	5
Peso Líquido-Bruto / Poids Net-Brut / Peso Neto-Bruto / Net-Gross Weight	kg	61-63
Gás / Gas / Gas / Gas	R600A	
Consumo energia / Consommation d'énergie / Cons.Energia / Energy Cons.	kWh/24h	0,61
Potência / Puissance / Potência / Power	W	45
Tensão / Tension / Tension / Tension	V	230



**NOVO  
NOUVEAU  
NUEVO  
NEW**

MODELO / MODÈLE / MODELO / MODEL	ARCA HORIZONTAL 402LTS	
CÓDIGO / CODE / CÓDIGO / CODE	2828.928	
<b>Preço / Prix / Precio / Price</b>	<b>€</b>	<b>929,00</b>
Dimensões / Dimensions / Dimensiones	mm	1504x700x895
Volume Útil / Volume Net / Volume Neto / Net Volume	lt	402
Temperatura / Température / Temperatura / Temperature	°C	-15/-25
Refrigeração / Refrigeration / Refrigeracion / Cooling	Eletrónica	
Cestos / Paniers / Cestos / Baskets	nr	6
Peso Líquido-Bruto / Poids Net-Brut / Peso Neto-Bruto / Net-Gross Weight	kg	68-71
Gás / Gas / Gas / Gas	R600A	
Consumo energia / Consommation d'énergie / Cons.Energia / Energy Cons.	kWh/24h	0,685
Potência / Puissance / Potência / Power	W	50
Tensão / Tension / Tension / Tension	V	230



UDIfri

## ARCAS CONGELADORAS - TAMPA DE VIDRO LEVANTAR

CONGELATEURS BAHUTS - COUVERCLE EN VERRE DE LEVER

CONGELADORES - TAPA DE LEVANTAR

FREEZERS - FLAT GLASS RISING LID



CHV  
Exterior em chapa galvanizada revestida a PVC  
Interior em chapa revestida a PVC atóxico  
Tubos em cobre e termómetro de Controlo de temperatura interna  
Esgoto frontal facilmente acessível



CHV  
Extérieur en tôle galvanisée avec revêtement en PVC  
Intérieur en tôle revêtu de PVC atoxique  
Évaporateur et condenseur en tube cuivre  
Écoulement frontal, facilement accessible



CHV  
Exterior en chapa galvanizada revestida a PVC  
Interior en chapa revestida a PVC atóxico  
Tubería totalmente en cobre  
Termómetro para control de temperatura interna  
Desagüe frontal, fácilmente accessible



CHV  
Exterior in white PVC-coated galvanised steel  
Interior in non-toxic PVC-coated galvanised steel.  
Copper tube evaporator and condenser.  
Thermometer to display internal temperature. Easy-access front defrost drain.



MODELO / MODÈLE / MODELO / MODEL	320 TAVI
CÓDIGO / CODE / CÓDIGO / CODE	2828.582
<b>Preço / Prix / Precio / Price</b>	€ <b>710,00</b>
Dimensões / Dimensions / Dimensiones	mm 1040x600x800
Volume Líquido / Volume Net / Volume Neto / Net Volume	lt 320
Temperatura / Température / Temperatura / Temperature	°C -18/-20
Gás / Gas / Gas / Gas	R134A
Refrigeração / Refrigeration / Refrigeracion / Cooling	S/V S
Cap. Cestos / Cap. Paniers / Cap. Cestos / Cap. Baskets	nr -
Peso Líquido-Bruto / Poids Net-Brut / Peso Neto-Bruto / Net-Gross Weight	kg 51/59
Potência / Puissance / Potência / Power	W 200
Tensão / Tension / Tension / Tension	V 230

MODELO / MODÈLE / MODELO / MODEL	620 TAVI
CÓDIGO / CODE / CÓDIGO / CODE	2828.586
<b>Preço / Prix / Precio / Price</b>	€ <b>1.012,00</b>
Dimensões / Dimensions / Dimensiones	mm 1400x600x830
Volume Líquido / Volume Net / Volume Neto / Net Volume	lt 392
Temperatura / Température / Temperatura / Temperature	°C -18/-20
Gás / Gas / Gas / Gas	R134A
Refrigeração / Refrigeration / Refrigeracion / Cooling	S/V S
Cap. Cestos / Cap. Paniers / Cap. Cestos / Cap. Baskets	nr -
Peso Líquido-Bruto / Poids Net-Brut / Peso Neto-Bruto / Net-Gross Weight	kg 72/83
Potência / Puissance / Potência / Power	W 290
Tensão / Tension / Tension / Tension	V 230

Cestos incluídos / Paniers inclus / Cestas incluidas / Baskets included

MODELO / MODÈLE / MODELO / MODEL	430 CHV / VLC
CÓDIGO / CODE / CÓDIGO / CODE	2098.860
<b>Preço / Prix / Precio / Price</b>	€ <b>1.162,00</b>
Dimensões / Dimensions / Dimensiones	mm 1400x600x830
Volume Líquido / Volume Net / Volume Neto / Net Volume	lt 392
Temperatura / Température / Temperatura / Temperature	°C -18/-20
Gás / Gas / Gas / Gas	R134A
Refrigeração / Refrigeration / Refrigeracion / Cooling	S/V S
Cap. Cestos / Cap. Paniers / Cap. Cestos / Cap. Baskets	nr 6
Peso Líquido-Bruto / Poids Net-Brut / Peso Neto-Bruto / Net-Gross Weight	kg 58/66
Potência / Puissance / Potência / Power	W 234
Tensão / Tension / Tension / Tension	V 230

M - Manual / A - Auto | V = Ventilada / Ventilé / Ventilada / Ventilated | S = Estática / Static / Estática / Static



confirmar disponibilidade  
confirmer la disponibilité  
confirmar la disponibilidad  
confirm the availability



Porta de correr de vidro com Isolamento de calor  
Grande capacidade e volume interior  
Fácil mobilidade com 4 rodas robustas  
Escoamento de água



Porte coulissante en verre avec chaleur isolation  
Grande capacité et volume interne  
Mobilité facile avec 4 roues robustes  
Ruissellement de l'eau



Puerta corredera de vidrio con aislamiento térmico  
Gran capacidad y volumen interior  
Fácil movilidad con 4 ruedas robustas  
Drenaje de agua



Heat-isolated sliding glass cover  
Wide inner volume enabling a high loading capacity  
Strong wheels providing mobility  
Water drainage

 Cestos / Paniers /  
Cestos / Basket

**CESTO P/  
UDIFRI  
300/400/500  
2828.918**
**16,00**

 opcional  
optionnel  
opcional  
optional

MODELO/MODÈLE/MODELO/MODEL CÓDIGO / CODE / CÓDIGO / CODE	UDIFRI 300 VC C/ FECHO 2828.912	
<b>Preço / Prix / Precio / Price</b>	<b>€</b>	<b>875,00</b>
Dimensões / Dimensions / Dimensiones	(LxPxA) mm	1009 x 615 x 949
Tipo refrigerante / Type de réfrigérant / Tipo refrigerante / Refrigerant type		R290
Tipo de Refrigeração / Tipey Réfrigération / Tipo Refrigeración / Cooling Type	S/V	S
Descongelação / Décongélation / Descongelación / Defrost	A/M	M
Temperaturas / Températures / Temperaturas / Temperature	°C	-12/-22
Volume útil / Volume utile / volumen útil / Net volume	L	238
Volume bruto / Volume brut / Volumen bruto / Gross volume	L	264
Cestos / Paniers / Cestos / Baskets Capacidade / Capacité / Capacidad / Capacity	nr	4
Peso bruto-líquido/ Poids brut-net/ Peso bruto-neto/ Gross-net weight	Kg	70-56
Consumo de energia / Consommation energetique / Consumo energia / Energy consumption	kWh/24h	2,9
Potência / Puissance / Potencia / Power	W	220
Tensão / Tension / Tensión / Tension	V	230



MODELO/MODÈLE/MODELO/MODEL CÓDIGO / CODE / CÓDIGO / CODE	UDIFRI 400 VC C/ FECHO 2828.914	
<b>Preço / Prix / Precio / Price</b>	<b>€</b>	<b>920,00</b>
Dimensões / Dimensions / Dimensiones	(LxPxA) mm	1298 x 615 x 949
Tipo refrigerante / Type de réfrigérant / Tipo refrigerante / Refrigerant type		R290
Tipo de Refrigeração / Tipey Réfrigération / Tipo Refrigeración / Cooling Type	S/V	S
Descongelação / Décongélation / Descongelación / Defrost	A/M	M
Temperaturas / Températures / Temperaturas / Temperature	°C	-12/-22
Volume útil / Volume utile / volumen útil / Net volume	L	296
Volume bruto / Volume brut / Volumen bruto / Gross volume	L	350
Cestos / Paniers / Cestos / Baskets Capacidade / Capacité / Capacidad / Capacity	nr	5
Peso bruto-líquido/ Poids brut-net/ Peso bruto-neto/ Gross-net weight	Kg	81-65
Consumo de energia / Consommation energetique / Consumo energia / Energy consumption	kWh/24h	4,4
Potência / Puissance / Potencia / Power	W	300
Tensão / Tension / Tensión / Tension	V	230



MODELO/MODÈLE/MODELO/MODEL CÓDIGO / CODE / CÓDIGO / CODE	UDIFRI 500 VC C/ FECHO 2828.916	
<b>Preço / Prix / Precio / Price</b>	<b>€</b>	<b>1.163,00</b>
Dimensões / Dimensions / Dimensiones	(LxPxA) mm	1548 x 615 x 949
Tipo refrigerante / Type de réfrigérant / Tipo refrigerante / Refrigerant type		R290
Tipo de Refrigeração / Tipey Réfrigération / Tipo Refrigeración / Cooling Type	S/V	S
Descongelação / Décongélation / Descongelación / Defrost	A/M	M
Temperaturas / Températures / Temperaturas / Temperature	°C	-12/-22
Volume útil / Volume utile / volumen útil / Net volume	L	398
Volume bruto / Volume brut / Volumen bruto / Gross volume	L	427
Cestos / Paniers / Cestos / Baskets Capacidade / Capacité / Capacidad / Capacity	nr	6
Peso bruto-líquido/ Poids brut-net/ Peso bruto-neto/ Gross-net weight	Kg	96-79
Consumo de energia / Consommation energetique / Consumo energia / Energy consumption	kWh/24h	6,4
Potência / Puissance / Potencia / Power	W	400
Tensão / Tension / Tensión / Tension	V	230





UDIFRI

**ARCAS CONGELADORAS - TAMPA DE VIDRO CURVO DE CORRER**

CONGELATEURS BAHUTS - COUVERCLE GLISSIERE EN VERRE COURBÉ

CONGELADORES - TAPA EN VIDRIO CURVO DE CORRER

FREEZERS - CURVED GLASS HINGED LID



Arca expositora para congelados, novo design, com portas de vidro deslizantes, inclui fechadura.



Arche pour congelés, nouveau design, avec portes coulissantes en verre, comprend verrouillage.



Arca expositoras de congelados, nuevo diseño, con puertas corredizas de vidrio, incluye cerradura.



Exhibiting freezer, new design, with sliding glass doors, includes lock.

Cestos / Paniers /  
Cestos / Basket



**CESTO P/  
UDIFRI  
300/400/500  
2828.918**



opcional  
optionnel  
optional

**16,00**



MODELO / MODÈLE / MODELO / MODEL	UDIFRI 300 VC C/ FECHO	
CÓDIGO / CODE / CÓDIGO / CODE	2828.920	
<b>Preço / Prix / Precio / Price</b>	<b>€</b>	<b>875,00</b>
Dimensões / Dimensions / Dimensiones	mm	1030x650x804
Dimensões Embalagem/ Dimensions de l'Emballage / Dimensiones del Embalaje / Packaging Dimensions	mm	1110x760x885
Volume / Volume / Volume / Volume	Lt	286
Temperatura / Température / Temperatura / Temperature	C°	-12/-22
Consumo energia/Consommation energetique/Consumo energia/ Energy consumption	kWh/24 h	2,70
Classe Climatica/ Classe Climatique/ Clase Climatica/ Climatic Class		4
Nível Ruído/ Niveau bruit/ Nivel Ruido/ Noise Level	dB	52,3
Gás refrigerante / Gaz réfrigérant / Gas refrigerante / Refrig. Gas		R290
Tipo Refrigeração / Refrigeration Type / Refrigeracion Tipo / Cooling Type		mecânica
Nº prateleiras-cestos / N° Étagères- paniers / N° Estantes - cestas/ N° of Shelves- baskets	nrº	4
Peso Líquido-Bruto /Poids Net-Brut /Peso Neto-Bruto /Net-Gross Weight	Kg	62/76
Potência / Puissance / Potencia / Power	W	240
Tensão / Tension / Tensión / Tension	V	230



MODELO / MODÈLE / MODELO / MODEL	UDIFRI 400 VC C/ FECHO	
CÓDIGO / CODE / CÓDIGO / CODE	2828.922	
<b>Preço / Prix / Precio / Price</b>	<b>€</b>	<b>920,00</b>
Dimensões / Dimensions / Dimensiones	mm	1320x650x804
Dimensões Embalagem/ Dimensions de l'Emballage / Dimensiones del Embalaje / Packaging Dimensions	mm	1400x760x885
Volume / Volume / Volume / Volume	Lt	388
Temperatura / Température / Temperatura / Temperature	C°	-12/-22
Consumo energia/Consommation energetique/Consumo energia/ Energy consumption	kWh/24 h	4,90
Classe Climatica/ Classe Climatique/ Clase Climatica/ Climatic Class		4
Nível Ruído/ Niveau bruit/ Nivel Ruido/ Noise Level	dB	53,8
Gás refrigerante / Gaz réfrigérant / Gas refrigerante / Refrig. Gas		R290
Tipo Refrigeração / Refrigeration Type / Refrigeracion Tipo / Cooling Type		mecânica
Nº prateleiras-cestos / N° Étagères- paniers / N° Estantes - cestas/ N° of Shelves- baskets	nrº	5
Peso Líquido-Bruto /Poids Net-Brut /Peso Neto-Bruto /Net-Gross Weight	Kg	72/87
Potência / Puissance / Potencia / Power	W	300
Tensão / Tension / Tensión / Tension	V	230



MODELO / MODÈLE / MODELO / MODEL	UDIFRI 500 VC C/ FECHO	
CÓDIGO / CODE / CÓDIGO / CODE	2828.924	
<b>Preço / Prix / Precio / Price</b>	<b>€</b>	<b>1.118,00</b>
Dimensões / Dimensions / Dimensiones	mm	1570x650x804
Dimensões Embalagem/ Dimensions de l'Emballage / Dimensiones del Embalaje / Packaging Dimensions	mm	1650x760x885
Volume / Volume / Volume / Volume	Lt	475
Temperatura / Température / Temperatura / Temperature	C°	-12/-22
Consumo energia/Consommation energetique/Consumo energia/ Energy consumption	kWh/24 h	5,85
Classe Climatica/ Classe Climatique/ Clase Climatica/ Climatic Class		4
Nível Ruído/ Niveau bruit/ Nivel Ruido/ Noise Level	dB	57,3
Gás refrigerante / Gaz réfrigérant / Gas refrigerante / Refrig. Gas		R290
Tipo Refrigeração / Refrigeration Type / Refrigeracion Tipo / Cooling Type		mecânica
Nº prateleiras-cestos / N° Étagères- paniers / N° Estantes - cestas/ N° of Shelves- baskets	nrº	6
Peso Líquido-Bruto /Poids Net-Brut /Peso Neto-Bruto /Net-Gross Weight	Kg	110/122
Potência / Puissance / Potencia / Power	W	400
Tensão / Tension / Tensión / Tension	V	230

M - Manual / A - Auto | V = Ventilada / Ventilé / Ventilada / Ventilated | S = Estática / Static / Estática / Static



Exterior em Chapa galvanizada revestida a PVC Interior em Chapa revestida a PVC atóxico.  
Tubos evaporador e condensador em cobre e termómetro Controlo temperatura interna. Esgoto frontal facilmente acessível.  
1100 CHV/V - 2 pares de tampas de correr transversais em vidro térmico  
CHV/V - 1 par de tampas de correr em vidro térmico  
CHV/2V - 2 pares de tampas de correr longitudinais em vidro térmico



Extérieur en tôle galvanisée avec revêtement en PVC. Intérieur en tôle revêtue de PVC atoxique. Évaporateur et condenseur en tube cuivre. Écoulement frontal, facilement accessible.  
1100 CHV/V - Fourni avec 2 paires de couvercles coulissants transversaux en verre thermique  
CHV/V - Fourni avec 1 paire de couvercles coulissants en verre thermique  
CHV/2V - Fourni avec 2 paires de couvercles coulissants longitudinaux en verre thermique



Exterior en chapa galvanizada revestida a PVC. Interior en chapa revestida a PVC atóxico.  
Tubería totalmente en cobre. Termómetro para control de temperatura interna. Desagüe frontal, fácilmente accesible  
1100 CHV/V - Suministrados con 2 pares de tapas de correr transversales en cristal térmico  
CHV/V - Suministrados con 1 par de tapas correderas en cristal térmico  
CHV/2V - Suministrados con 2 pares de tapas correderas longitudinales en cristal térmico.



Exterior in white PVC-coated galvanised steel. Interior in non-toxic PVC-coated galvanised steel. Copper tube evaporator and condenser. Thermometer to display internal temperature. Easy-access front defrost drain.  
1100 CHV/V - Supplied with 2 pairs of transversal thermal glass sliding lids.  
CHV/V - Supplied with 1 pair of thermal glass sliding lids.  
CHV/2V - Supplied with 2 pairs of longitudinal thermal glass sliding lids

MODELO	STANDARD			
	DIVISÓRIAS		CESTOS	CAPACIDADE DE CESTOS
	ALTA	BAIXA		
750 CHV/V	1	1	1	5
750 CHV/2V	1	1	2	10
900 CHV/V	2	1	1	6
900 CHV/2V	2	1	2	12
1100 CHV/V	2	1	1	8
1100 CHV/2V	2	1	2	16



MODELO / MODÈLE / MODELO / MODEL		750 CHV / V	900 CHV / V	1100 CHV / V
<b>CÓDIGO / CODE / CÓDIGO / CODE</b>		<b>2098.825</b>	<b>2098.830</b>	<b>2098.835</b>
<b>Preço / Prix / Precio / Price</b>	€	<b>1.955,00</b>	<b>2.228,00</b>	<b>2.728,00</b>
Dimensões / Dimensions / Dimensiones	mm	1550x960x780	2050x960x780	2500x960x780
Volume Bruto / Volume Brut / Volume Bruto / Gross Volume	lt	597	839	1032
Temperatura / Température / Temperatura / Temperature	°C	-18/-20	-18/-20	-18/-20
Descongelação / Décongélation / Descong. / Defrosting	M/A	M	M	M
Peso Líquido-Bruto / Poids Net-Brut / Peso Neto-Bruto / Net-Gross Weight	kg	81/96	105/120	125/142
Potência / Puissance / Potência / Power	W	370	410	410
Tensão / Tension / Tension / Tension	V	230	230	230



MODELO / MODÈLE / MODELO / MODEL		750 CHV / 2V	900 CHV / 2V	1100 CHV / 2V
<b>CÓDIGO / CODE / CÓDIGO / CODE</b>		<b>2098.840</b>	<b>2098.845</b>	<b>2098.850</b>
<b>Preço / Prix / Precio / Price</b>	€	<b>2.015,00</b>	<b>2.303,00</b>	<b>2.743,00</b>
Dimensões / Dimensions / Dimensiones	mm	1550x960x780	2050x960x780	2500x960x780
Volume Bruto / Volume Brut / Volume Bruto / Gross Volume	lt	597	839	1032
Temperatura / Température / Temperatura / Temperature	°C	-18/-20	-18/-20	-18/-20°C
Descongelação / Décongélation / Descong. / Defrosting	M/A	M	M	M
Peso Líquido-Bruto / Poids Net-Brut / Peso Neto-Bruto / Net-Gross Weight	kg	81/96	105/120	125/143
Potência / Puissance / Potência / Power	W	370	410	594
Tensão / Tension / Tension / Tension	V	230	230	230

M - Manual / A - Auto | V = Ventilada / Ventilé / Ventilada / Ventilated | S = Estática / Static / Estática / Static



UDIfri

**CONGELADORES PROFISSIONAIS CHV/V/2V - ACESSÓRIOS**  
CONGELATEURS BAHUTS PROFESSIONNELS CHV/V/2V - ACCESSOIRES  
CONGELADORES PROFESIONALES CHV/V/2V - ACCESORIOS  
PROFESSIONAL FREEZERS CHV/V/2V - ACCESSORIES



750 | 900 | 1100 > CHV/V  
2098.892

**CONSULTAR**

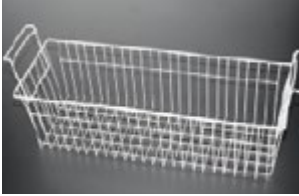

**Cesto / Basket**  
Dim. (mm):  
765x275x230

750 | 900 | 1100 > CHV/2V  
2098.894

**CONSULTAR**



**Cesto / Basket**  
Dim. (mm): 335x275x230

750 | 900 | 1100 > CHV/V  
2098.906

**CONSULTAR**



**Cesto / Basket**  
Dim. (mm): 355x275x230  
\* Aplicação com barra de inox  
\* Application with stainless steel bar

750 | 900 | 1100 CHV/V  
2098.922 | 2098.908 | 2098.891

**CONSULTAR**



**Tubo de suporte / Support tube**  
Dim. (mm):  
(a) 2098.922 | 1368x40x40 mm  
(b) 2098.908 | 1865x40x40 mm  
(c) 2098.924 | (2x) 1123 x 40 x 40 mm

750 | 900 | 1100 » CHV/V /  
CHV/2V  
2098.899

**CONSULTAR**

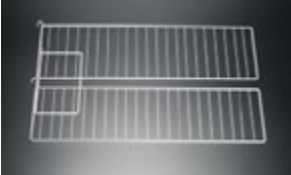

**Divisória pequena longitudinal  
Small longitudinal Divider**  
Dim. (mm):  
770 x 466

750 | 900 | 1100 » CHV/V /  
CHV/2V  
2098.899A

**CONSULTAR**

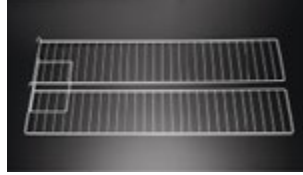

**Divisória grande longitudinal  
Big longitudinal Divider**  
Dim. (mm):  
1022 x 466 mm

750 | 900 | 1100 » CHV/V /  
CHV/2V  
2098.900

**CONSULTAR**

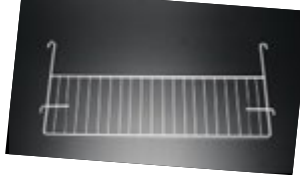

**Divisória baixa transversal  
Low height divider**  
Dim. (mm):  
770 x 221 mm

750 | 900 | 1100 » CHV/V /  
CHV/2V  
2098.902

**CONSULTAR**



**Divisória alta transversal  
High divider**  
Dim. (mm):  
770 x 471 mm

750 | 900 | 1100 » CHV/V /  
CHV/2V  
2098.885 | 2098.886 |  
2098.883

**CONSULTAR**



**Perfil de preços / Ticket strip**  
Dim. (mm):  
2098.885 | 1368 x 45  
750 CHV/V; 750 CHV/2V

2098.886 | 1840 x 45  
900 CHV/V; 900 CHV/2V

2098.883 | 1125 x 45(x2) |  
1100 CHV/V; 1100 CHV/2V

CHV/2V  
2098.896

**CONSULTAR**



**Divisória Cesto / Basket Divider**  
Dim. (mm):  
285x212



Congelador de ilha jumbo estático com  
 descongelamento automático e porta de  
 correr em vidro.  
 Chapa de superfície externa pré-pintada  
 com tratamento anticorrosão  
 Revestimento interno em alumínio branco.  
 Sistema de abertura deslizante.  
 Termóstato eletrónico.  
 Iluminação LED  
 Espessura de isolamento 73,5mm



Congélateur d'îlot jumbo statique  
 avec dégivrage automatique et vitre  
 coulissante.  
 Tôle de surface externe prépeinte avec  
 traitement anticorrosion  
 Doublure intérieure en aluminium blanc.  
 Système d'ouverture coulissant.  
 Thermostat électronique.  
 Éclairage LED  
 Épaisseur d'isolation 73,5mm



Congelador de isla jumbo estático con  
 descongelación automática y puerta  
 corrediza de vidrio.  
 Chapa de superficie externa pré-pintada  
 con tratamiento anticorrosión  
 Revestimiento interior de aluminio  
 blanco.  
 Sistema de apertura deslizante.  
 Termóstato electrónico.  
 Iluminación LED  
 Espesor de aislamiento 73,5mm



Static jumbo island freezer with  
 automatic defrost with sliding glass.  
 External surface prepainted sheet with  
 anticorrosion treatment  
 Inner liner in white aluminium.  
 Sliding opening system.  
 Electronic thermostat.  
 Led Lighting  
 Insulation thickness 73,5mm

**NOVO**  
**NOUVEAU**  
**NUEVO**  
**NEW**



MODELO / MODÈLE / MODELO / MODEL	UDMANHATTAN 21	
CÓDIGO / CODE / CÓDIGO / CODE	2829.968	
<b>Preço / Prix / Precio / Price</b>	€	<b>3.924,00</b>
Dimensões / Dimensions / Dimensiones	mm	2100X850X870
Volume Útil / Volume Net / Volume Neto / Net Volume	lt	646
Temperatura / Température / Temperatura / Temperature	°C	0/+10 -22/-18
Iluminação / Éclairage / Iluminación / Lighting		LED
Separadores / Onglets / Separadores / Separators	nr	4
Descongelação / Décongélation / Descong. / Defrosting	lt	Gás Quente Hot Gas
Peso Líquido-Bruto / Poids Net-Brut / Peso Neto-Bruto / Net-Gross Weight	kg	136-188
Gás / Gas / Gas / Gas		R290
Consumo energia / Consommation d'énergie / Cons.Energia / Energy Cons.	kWh/24h	10,88
Potência / Puissance / Potência / Power	W	500
Tensão / Tension / Tension / Tension	V	230



UDIfri

**EXPOSITORES PROFSSIONAIS CONGELADOS - TAMPA DE CORRER - SUPER**  
 CONGELATEURS BAHUTS PROFESSIONNELS - COUVERCLE EN VERRE COULISSANT - SUPER  
 CONGELADORES - TAPA EN VIDRIO DESLIZANTE - SUPER  
 FREEZERS - SLIDING GLAS LID COVER - SUPER



**LINHA SUPER**



Interior e exterior em chapa galvanizada revestida a PVC de acordo com normativas alimentares.  
 Evaporador, condensador e todo o circuito de frio em cobre.  
 Condensador livre de manutenção.  
 2 Grupos frigoríficos de elevado rendimento (COP) e baixa emissão térmica.  
 Gas refrigerante R134a ou R290 como opcional.  
 Descongelção automática por gás quente nos modelos D.  
 DE - descongelção automática com evaporador de água.  
 Fundo falso ajustável em altura nos modelos D.  
 Iluminação LED.  
 Personalização



Intérieur et extérieur en tôle galvanisée avec revêtement atoxique en PVC d'accord réglementations alimentaires.  
 Evaporateur, condensateur et tube en cuivre.  
 Condensateur sans maintenance.  
 2 groupes frigorifiques de grand efficacité (COP) et faibles émission thermique.  
 Réfrigérant R134a ou R290 disponible en option.  
 Dégivrage automatique par gaz chaud.  
 DE - Modèles avec évaporateur d'eau à dégivrage automatique.  
 Dégivrage automatique par gaz chaud en modèles D.  
 Eclairage interior LED.  
 Customisation.



Interior y exterior en chapa de acero galvanizado recubierta con PVC de acuerdo con normativas alimentarias.  
 Evaporador, condensador y toda la tubería en cobre.  
 Condensador sin mantenimiento.  
 2 Grupos frigoríficos elevado rendimiento ( COP) y baja emisión térmica.  
 Gas refrigerante R134a o R290 como opcional.  
 Desescarche automático por gas caliente opcional.  
 DE - descongelamiento automático modelos con evaporador de agua.  
 Desescarche automático por gas caliente en los modelos D.  
 Iluminación LED opcional.  
 Personalización.



Internal and external nontoxic PVC coated hot galvanized steel according to the food regulations.  
 Evaporator, condenser and all tubes in cooper.  
 Free maintenance condenser.  
 2 high efficiency cooling groups (COP) and low thermic emission.  
 Refrigerant gas R134a or R290 as optional.  
 Automatic defrost by hot gas on models D.  
 DE - Automatic defrost models with water evaporator.  
 False adjustable bottom on models D.  
 LED lighting.  
 Customization.

**COR PRETA EM OPÇÃO**  
**COULEUR NOIR EN OPTION**  
**OPCIÓN DEL COLOR NEGRO**  
**OPTIONAL BLACK COLOR**



MODELO / MODÈLE / MODELO / MODEL	SUPER 150DE	
CÓDIGO / CODE / CÓDIGO / CODE	2098.971	
<b>Preço / Prix / Precio / Price</b>	€	<b>2.857,00</b>
Dimensões / Dimensions / Dimensiones	mm	1520X920X 790
Descongelção / Décongélation / Descongelación / Defrost	M/A	A
Controlo / Contrôle / Control / Control	Electrónico	
Temperaturas / Températures / Temperaturas / Temperature	°C	-18/-28
Volume útil / Volume utile / volumen útil / Net volume	L	400
Volume Bruto / Volume brut / Volumen Bruto / Gross volume	L	570
Cap. Cestos / Cap. Paniers / Cap. Cestas / Baskets Cap.	nr	3
Divisórias / Divisions / Divisórias / Dividers	nr	2
Peso Líquido-Bruto / Poids Net-Brut/ Peso Neto-Bruto / Net-Gross Weight	Kg	98-141
Potência de entrada / Puissance entré / Potencia entrada / Inlet power	W	471
Tensão / Tension / Tensión / Tension	V	230

MODELO / MODÈLE / MODELO / MODEL	SUPER 200 DE	
CÓDIGO / CODE / CÓDIGO / CODE	2098.989	
<b>Preço / Prix / Precio / Price</b>	€	<b>3.110,00</b>
Dimensões / Dimensions / Dimensiones	mm	2020x920x 790
Descongelção / Décongélation / Descongelación / Defrost	M/A	A
Controlo / Contrôle / Control / Control	Electrónico	
Temperaturas / Températures / Temperaturas / Temperature	°C	-18/-28
Volume útil / Volume utile / volumen útil / Net volume	L	580
Volume Bruto / Volume brut / Volumen Bruto / Gross volume	L	800
Cap. Cestos / Cap. Paniers / Cap. Cestas / Baskets Cap.	nr	5
Divisórias / Divisions / Divisórias / Dividers	nr	2
Peso Líquido-Bruto / Poids Net-Brut/ Peso Neto-Bruto / Net-Gross Weight	Kg	167-187
Potência de entrada / Puissance entré / Potencia entrada / Inlet power	W	662
Tensão / Tension / Tensión / Tension	V	230

MODELO / MODÈLE / MODELO / MODEL	SUPER TOPO DE	
CÓDIGO / CODE / CÓDIGO / CODE	2098.991	
<b>Preço / Prix / Precio / Price</b>	€	<b>3.482,00</b>
Dimensões / Dimensions / Dimensiones	mm	1990x920x 790
Descongelção / Décongélation / Descongelación / Defrost	M/A	A
Controlo / Contrôle / Control / Control	Electrónico	
Temperaturas / Températures / Temperaturas / Temperature	°C	-18/-28
Volume útil / Volume utile / volumen útil / Net volume	L	430
Volume Bruto / Volume brut / Volumen Bruto / Gross volume	L	540
Cap. Cestos / Cap. Paniers / Cap. Cestas / Baskets Cap.	nr	0
Divisórias / Divisions / Divisórias / Dividers	nr	2
Peso Líquido-Bruto / Poids Net-Brut/ Peso Neto-Bruto / Net-Gross Weight	Kg	121-162
Potência de entrada / Puissance entré / Potencia entrada / Inlet power	W	662
Tensão / Tension / Tensión / Tension	V	230

Cestos Paniers /  
Cestos / Basket



confirmar disponibilidade  
 confirmer la disponibilité  
 confirmar la disponibilidad  
 confirm the availability

opcional  
 optionnel  
 opcional  
 optional

## LINHA SUPER



**SUPER**  
 Termómetro digital.  
 Termostato mecánico.  
 Iluminação LED.

**SUPER D**  
 Descongelación automática.  
 Controlador electrónico de temperatura.  
 Fundo interior ajustável em altura.  
 Iluminação LED.

DE - Descongelación automática com evaporador de água.



**SUPER**  
 Thermomètre digital.  
 Thermostat mécanique.  
 Eclairage intérieur LED.

**SUPER D**  
 Dégivrage automatique.  
 Contrôleur électronique de température.  
 Fond intérieur réglable en hauteur.  
 Eclairage intérieur LED.

DE - Modèles avec évaporateur d'eau à dégivrage automatique.



**SUPER**  
 Termómetro digital.  
 Termostato mecánico.  
 Iluminación LED.

**SUPER D**  
 Desescarche automático.  
 Controlador electrónico de temperatura.  
 Fondo ajustable en altura.  
 Iluminación LED.

DE - descongelamiento automático modelos con evaporador de agua.



**SUPER**  
 Digital thermometer.  
 Mechanic thermostat.  
 LED lighting.

**SUPER D**  
 Automatic defrost.  
 Electronic temperature controller.  
 Adjustable false bottom.  
 LED lighting.

DE - Automatic defrost models with water evaporator..



**COR PRETA EM OPÇÃO**  
**COULEUR NOIR EN OPTION**  
**OPCIÓN DEL COLOR NEGRO**  
**OPTIONAL BLACK COLOR**

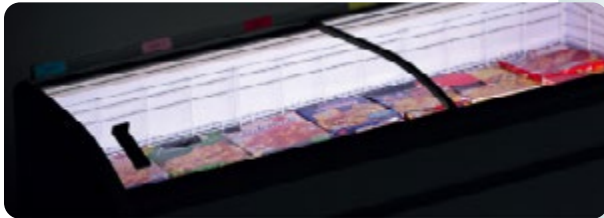

MODELO / MODÈLE / MODELO / MODEL	SUPER 250 DE	
CÓDIGO / CODE / CÓDIGO / CODE	2098.976C	
<b>Preço / Prix / Precio / Price</b>	<b>€</b>	<b>3.497,00</b>
Dimensões / Dimensions / Dimensiones	(LxPxX) mm	2500X930X 790
Descongelación / Décongélation / Descongelación / Defrost	A	
Controlo / Contrôle / Control / Control	Electrónico	
Volume útil / Volume utile / volumen útil / Net volume	lt	750
Volume Bruto / Volume Brut / Volumen Bruto / Gross Volume	lt	1030
Temperaturas / Températures / Temperaturas / Temperature	°C	-18/-28
Cap. Cestos / Cap. Paniers / Cap. Cestas / Baskets Cap.	nr	7
Divisórias / Divisions / Divisórias / Dividers	nr	2
Peso Líquido-Bruto / Poids Net-Brut / Peso Neto-Bruto / Net-Gross Weight	kg	148-198
Potência / Puissance / Potencia / Power	W	681
Tensão / Tension / Tensión / Tension	V	230

Cestos / Paniers /  
 Cestos / Basket



opcional  
 opcional  
 optional

Página seguinte  
 Page suivante  
 Página siguiente  
 Next page



UDIfri

## EXPOSITORES PROFSSIONAIS CONGELADOS SUPER - ACESSÓRIOS

CONGELATEURS BAHUTS PROFESSIONNELS SUPER - ACCESSOIRES

CONGELADORES PROFESIONALES SUPER - ACCESORIOS

PROFESSIONAL FREEZERS SUPER - ACCESSORIES



SUPER 200  
2098.896

CONSULTAR

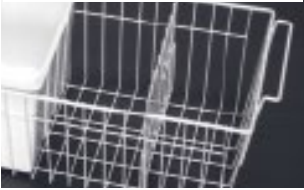

Divisória Cesto / Basket Divider

Dim. (mm):  
285x212

SUPER 200  
2098.981

CONSULTAR

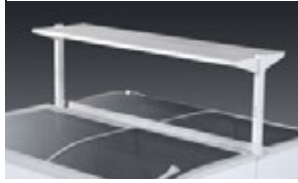

KIT prateleira dupla / Double Shelf

Dim. (mm):

SUPER 200  
2098.996

CONSULTAR



Cesto / Basket

Dim. (mm):

SUPER 150 | SUPER 200  
2098.982 | 2098.999

CONSULTAR



KIT união Joint KIT

Dim. (mm):

SUPER 150 | SUPER 200  
2098.983 | 2098.884A

CONSULTAR



Perfil de preços / Ticket strip

Dim. (mm):

SUPER 200  
2098.948

CONSULTAR



KIT prateleira Duas duplas /  
Double shelf

SUPER 200 | SUPER TOPO  
2098.966 | 2098.964

CONSULTAR



Rodapé / Skirting

SUPER 200  
2098.997A

CONSULTAR



Divisória / Divider

Dim. (mm):

SUPER TOPO  
2098.998A

CONSULTAR



Divisória / Divider

Dim. (mm):



### SUPER GRUPO 8



## LINHA DUPLA 2.2DE



DUPLA 2.2 DE  
Interior e exterior em chapa galvanizada revestida a PVC de acordo com normativas alimentares.  
Evaporador, condensador e todo o circuito de frio em cobre.  
Condensador livre de manutenção.  
2 Grupos frigoríficos de elevado rendimento (COP) e baixa emissão térmica.  
Alta eficiência energética e baixos custos de operação.  
Gas refrigerante R290 ou R134a como opcional.  
Descongelção automática por gás quente.  
Fundo falso ajustável em altura nos modelos D.  
Iluminação dupla de LED.  
Personalização.  
Isolamento: 80mm  
Não leva cestos, apenas divisórias.



DUPLA 2.2 DE  
Intérieur et extérieur en tôle galvanisée avec revêtement atoxique en PVC d'accord réglementations alimentaires.  
Évaporateur, condensateur et tube en cuivre.  
Condensateur sans maintenance.  
2 groupes frigoríficos de grand efficacité (COP) et faibles émission thermique.  
Grand efficacité d'énergie et faible coût de fonctionnement.  
Réfrigérant R290 ou R134a disponible en option.  
Dégivrage automatique par gaz chaud.  
Faux fonds ajustable.  
Double éclairage intérieur LED.  
Customisation  
Isolément: 80mm  
Pas de paniers, seulement des séparateurs.



DUPLA 2.2 DE  
Interior y exterior en chapa de acero galvanizado recubierta con PVC de acuerdo con normativas alimentarias.  
Evaporador, condensador y toda la tubería en cobre.  
Condensador sin mantenimiento.  
2 Grupos frigoríficos elevado rendimiento (COP) y baja emisión térmica.  
Alta eficiencia energética y bajos costes de operación.  
Gas refrigerante R290 o R134a como opcional.  
Desescarche automático por gas caliente.  
Fondo falso ajustable.  
Doble iluminación LED.  
Personalización.  
Aislamiento: 80mm  
No lleva cestas, sólo separadores.



DUPLA 2.2 DE  
Internal and external nontoxic PVC coated hot galvanized steel according to the food regulations.  
Evaporator, condenser and all tubes in cooper.  
Free maintenance condenser.  
2 high efficiency cooling groups (COP) and low thermic emission.  
High energy efficiency and low operation costs.  
Refrigerant gas R290 or R134a as optional.  
Automatic defrost by hot gas.  
False adjustable bottom.  
Double LED lighting.  
Customization.  
Insulation: 80mm  
It does not take baskets, just dividers.



MODELO / MODÈLE / MODELO / MODEL	DUPLA	
CÓDIGO / CODE / CÓDIGO / CODE	2098.866B	
<b>Preço / Prix / Precio / Price</b>	€	<b>5.307,00</b>
Dimensões / Dimensions / Dimensiones	mm	2150x1465x930
Tipo refrigerante / Type de réfrigérant / Tipo refrigerante / Refrigerant type		R290
Descongelção / Décongélation / Descongelación / Defrost		Auto
Temperaturas / Températures / Temperaturas / Temperature	°C	-18/-28
Volume útil / Volume utile / volumen útil / Net volume	L	1255
Volume Bruto / Volume brut / Volumen Bruto / Gross volume	L	1697
Peso Bruto-líquido / Poids brut-net / Peso Bruto-neto / Gross-net weight	Kg	251/198
Potência de entrada / Puissance entré / Potencia entrada / Inlet power	W	522
Tensão / Tension / Tensión / Tension	V	230

MODELO / MODÈLE / MODELO / MODEL	TOPO DUPLA	
CÓDIGO / CODE / CÓDIGO / CODE	2098.866C	
<b>Preço / Prix / Precio / Price</b>	€	<b>3.096,00</b>
Dimensões / Dimensions / Dimensiones	mm	1470x811x902
Tipo refrigerante / Type de réfrigérant / Tipo refrigerante / Refrigerant type		R290
Descongelção / Décongélation / Descongelación / Defrost		Auto
Temperaturas / Températures / Temperaturas / Temperature	°C	-18/-28
Volume útil / Volume utile / volumen útil / Net volume	L	334
Volume Bruto / Volume brut / Volumen Bruto / Gross volume	L	425
Peso Bruto-líquido / Poids brut-net / Peso Bruto-neto / Gross-net weight	Kg	125/85
Potência de entrada / Puissance entré / Potencia entrada / Inlet power	W	237
Tensão / Tension / Tensión / Tension	V	230



**PORTA PREÇOS P/ DUPLA 2.2**

Dim. (mm):

**2098.968**

**CONSULTA**



**DISPENSADOR SACOS TÉRMICOS PARA TOPO**

Dim. (mm):

**SOB CONSULTA**

**CONSULTA**

**SUGESTÃO DE COMBINAÇÃO**  
6 x EXPOSITOR + DIVISÓRIAS +  
SUPORTE SACOS TÉRMICOS (OPCIONAL)







UDIFRI

EXPOSITORES PROFissionais CONGELADOS UDIFRI

EXPOSITEURS CONGELÉES PROFESSIONNELS UDIFRI

EXPOSITORES DE CONGELADOS PROFESIONALES UDIFRI

PROFESSIONAL FREEZING SHOWCASES UDIFRI



## UDIFRI 1860 DA



Vidro temperado  
Baixo custo de investimento e de operação  
Várias possibilidades de instalação no mercado (parede em linha, ilha)  
Baixo consumo de energia utilizando controlador eletrónico  
Grande capacidade útil  
Sistema ajustável de 12 divisórias  
Design compacto e ergonómico, permitindo exposição de mais produto  
Termostato eletrónico ajustável  
LED de energia para exposição perfeita do produto e menor consumo de energia  
Descongelação automática  
Perfil de proteção ao choque



Verre trempé  
Coût d'investissement et de fonctionnement basse  
Différentes possibilités d'installation dans le marché (autonome en ligne jusqu'à l'île)  
Faible consommation d'énergie en utilisant contrôleur électronique  
Grand capacité utile  
Design compact et ergonomique, permettant l'affichage de plus de produits  
Système réglable de 12 partitions  
Thermostat électronique réglable  
Power LED pour l'affichage de produit parfait et faible consommation d'énergie  
Dégivrage automatique  
Profil de protection contre les chocs



Vidrio templado  
Bajo costo de inversión y operación  
Varias posibilidades de instalación en el mercado (pared en línea, isla)  
Bajo consumo de energía mediante uso de un controlador electrónico  
Gran capacidad útil  
Diseño compacto y ergonómico, permitiendo que más exposición del producto  
Sistema 12 estantes ajustables  
Termostato electrónico ajustable  
LED de alimentación para exhibición de productos perfecta y consumo de energía bajo  
Descongelación automática  
Perfil de protección contra impactos



Tempered Glass  
Low investment and operation cost  
Various installation possibilities in market (stand alone-in line up-island)  
Lower energy consumption by using electronic controller  
Large, useful capacity  
Compact and ergonomic design, allowing more product display  
Adjustable system with 12 dividers  
Adjustable electronic thermostat  
Power LED for perfect product display and lower energy consumption  
Automatic defrosting  
Shock protection profile



MODELO/MODÈLE/MODELO/MODEL CÓDIGO / CODE / CÓDIGO / CODE	UDIFRI 1860 DA VC	
		<b>2828.930</b>
<b>Preço / Prix / Precio / Price</b>	<b>€</b>	<b>2.745,00</b>
Dimensões / Dimensions / Dimensiones	(LxPx(A) mm)	1856 x 858 x 890
Tipo refrigerante / Type de réfrigérant / Tipo refrigerante / Refrigerant type		R404A
Descongelação / Décongélation / Descongelación / Defrost	M/A	A
Tipo de Refrigeração / Tipey Réfrigération / Tipo Refrigeración / Cooling Type	S/V	S
Temperaturas / Températures / Temperaturas / Temperature	°C	-18/-23
Volume útil / Volume utile / volumen útil / Net volume	L	563
Classe climática / Clase climatique / Clase climática / Climatic class		3
Nível de ruído / Niveau bruit / Nivel ruido / Noise level	dB	54,5
Prateleiras-cestos/Etagères-paniers/Estantes-cestas/Shelves-baskets		12/Opc.
Peso Líquido-Bruto / Poids Net-Brut/ Peso Neto-Bruto / Net-Gross Weight	Kg	122-138
Consumo de energia / Consommation energetique / Consumo energia / Energy consumption	kWh/24h	7,25
Potência / Puissance / Potencia / Power	W	500
Tensão / Tension / Tensión / Tension	V/Hz	230/50



MODELO/MODÈLE/MODELO/MODEL CÓDIGO / CODE / CÓDIGO / CODE	TOPO UDIFRI 1860 DA VC	
		<b>2828.932</b>
<b>Preço / Prix / Precio / Price</b>	<b>€</b>	<b>2.789,00</b>
Dimensões / Dimensions / Dimensiones	(LxPx(A) mm)	1856 x 858 x 815
Tipo refrigerante / Type de réfrigérant / Tipo refrigerante / Refrigerant type		R404A
Descongelação / Décongélation / Descongelación / Defrost	M/A	A
Tipo de Refrigeração / Tipey Réfrigération / Tipo Refrigeración / Cooling Type	S/V	S
Temperaturas / Températures / Temperaturas / Temperature	°C	-18/-23
Volume útil / Volume utile / volumen útil / Net volume	L	470
Classe climática / Clase climatique / Clase climática / Climatic class		3
Nível de ruído / Niveau bruit / Nivel ruido / Noise level	dB	54,5
Prateleiras-cestos/Etagères-paniers/Estantes-cestas/Shelves-baskets		12/Opc.
Peso Líquido-Bruto / Poids Net-Brut/ Peso Neto-Bruto / Net-Gross Weight	Kg	111-126
Consumo de energia / Consommation energetique / Consumo energia / Energy consumption	kWh/24h	7,25
Potência / Puissance / Potencia / Power	W	500
Tensão / Tension / Tensión / Tension	V/Hz	230/50



opcional  
opcionnel  
opcional  
optional

CÓD.	KIT LIGAÇÃO / KIT CONNECTION / KIT LIGACIÓN / CONNECTION KIT	€
2828.938	COMPLETA - 2 ARCAS	<b>213,00</b>
2828.940	COMPLETA VC - 4 ARCAS	<b>357,00</b>
2828.942	COMPLETA VC - 6 ARCAS	<b>501,00</b>
2828.946	SUPERIOR VC -2+2TOPOS	<b>77,00</b>
2828.948	SUPERIOR VC-4+2TOPOS	<b>151,00</b>
2828.950	SUPERIOR VC-8+2TOPOS	<b>299,00</b>
2828.952	INFERIOR VC-2+2TOPOS	<b>296,00</b>
2828.954	INFERIOR VC-4+2TOPOS	<b>364,00</b>
2828.955	INFERIOR VC-6+2TOPOS	<b>370,00</b>
2828.956	INFERIOR VC-8+2TOPOS	<b>528,00</b>





4 x UDIFRI 1860DA VC + 2 x TOPO UDIFRI 1860DA VC

M - Manual / A - Auto | V = Ventilada / Ventilé / Ventilada / Ventilated | S = Estática / Static / Estática / Static

 Perfeita para armazenamento de peixe fresco ou congelado

 Parfait pour le stockage de poisson frais ou congelé

 Perfecta para el almacenamiento de pescado fresco o congelado

 Perfect for fresh or frozen fish storage



MODELO / MODÈLE / MODELO / MODEL	ARMÁRIO CONSERVAÇÃO DE PEIXE	
CÓDIGO / CODE / CÓDIGO / CODE	2829.952	
Preço / Prix / Precio / Price	€	2.620,00
Dimensões / Dimensions / Dimensiones	mm	680x810x2000
Volume Líquido-Bruto / Volume Net-Brut / Volume Neto - Bruto / Net-Gross Volume	lt	470-537
Temperatura / Température / Temperatura / Temperature	°C	-5/+5
Refrigeração / Refrigeration / Refrigeracion / Cooling	V/S*	V
Descongelação / Décongélation / Descongelación / Defrost		Auto
Gás refrigerante / Gaz réfrigérant / Gas refrigerante / Refrig. Gas		R134
Gavetas / Tiroirs / Cajones / Drawers	nr	7
Peso Líquido / Poids Net / Peso Neto / Net Weight	kg	117
Potência / Puissance / Potencia / Power	w	265
Tensão / Tension / Tensión / Tension	V	230

\*V = Ventilada / Ventilé / Ventilada / Ventilated | S = Estática / Static / Estática / Static



UDIfri

**DEMOLHADORES BACALHAU**  
DESSALEURS  
REMOJADORES  
COD FISH SOAKERS



**DB1000**  
Interior e exterior em PVC;  
Entrada de água manual;  
Com esgoto;  
Capacidade: +/- 300 postas bacalhau.  
Tampas e base em aço inox.  
**UDB1500A / UDB3000A**  
Cuba inox com isolamento em poliuretano de alta densidade com 40Kg/m<sup>3</sup>;  
Tampas de correr inox;  
Sistema de refrigeração constituído por grupo compressor hermético arrefecido a ar forçado e placa fria com tubo de cobre de 3/8 nas paredes do tanque interior;  
Controlo e visualização da temperatura através de microprocessador eletrónico  
Programador horário e válvula de entrada de água automática com saída de água salgada por tubo de esgoto;  
Tubo para saída de água de limpeza do tanque;  
Chapa inox perfurada no fundo para apoio.



**DB1000**  
Intérieur et extérieur PVC;  
Entrée d'eau manuel;  
Avec sortie des eaux usées;  
Capacité: +/-300 morceaux de morue.  
Couvercles et base en acier inoxydable.  
**UDB1500A / UDB3000A**  
Isolation en acier inoxydable avec isolation en polyuréthane haute densité avec 40 kg / m<sup>3</sup>;  
Couvercles en acier inoxydable;  
Système de refroidissement comprenant un groupe compresseur hermétique refroidi par air forcé et une plaque froide avec un tube en cuivre 3/8 sur les parois du réservoir intérieur;  
Contrôle et visualisation de la température via microprocesseur électronique  
Programmateur horaire et vanne d'arrivée d'eau automatique avec sortie d'eau salée par le tuyau de vidange;  
Tuyau de sortie d'eau de nettoyage du réservoir;  
Tôle perforée en acier inoxydable dans le bas pour le soutien.



**DB1000**  
Interior y exterior de PVC;  
Entrada de agua manual;  
Con salida de aguas residuales;  
Capacidad: +/- 300 piezas bacalao.  
Tapas y base de acero inoxidable.  
**UDB1500A / UDB3000A**  
Cuba inox con aislamiento en poliuretano de alta densidad con 40Kg / m<sup>3</sup>;  
Cubiertas de acero inoxidable;  
Sistema de refrigeración constituído por grupo compresor hermético enfriado por aire forzado y placa fría con tubo de cobre de 3/8 en las paredes del tanque interior;  
Control y visualización de la temperatura a través de microprocesador electrónico  
Programador horario y válvula de entrada de agua automática con salida de agua salada por tubo de desagüe;  
Tubo para salida de agua de limpieza del tanque;  
Chapa inox perforada en el fondo para apoyo.



**DB1000**  
Interior and exterior in PVC;  
Manual water inlet;  
With sewage;  
Capacity: +/-300 co pieces.  
Stainless steel covers and base.  
**UDB1500A / UDB3000A**  
Stainless steel insulation with high density polyurethane insulation with 40Kg / m<sup>3</sup>;  
Stainless steel covers;  
Cooling system consisting of forced air cooled hermetic compressor set and cold plate with 3/8 copper tube on the walls of the inner tank;  
Temperature control and visualization via electronic microprocessor  
Time scheduler and automatic water inlet valve with outlet of salt water by drain pipe;  
Tank cleaning water outlet pipe;  
Stainless steel perforated plate in the bottom for support.



MODELO/MODÈLE/MODELO/MODEL		UDB1500A	UDB3000A
CÓDIGO / CODE / CÓDIGO / CODE		2058.602	2058.604
<b>Preço / Prix / Precio / Price</b>	<b>€</b>	<b>4.544,00</b>	<b>5.591,00</b>
Dimensões / Dimensions / Dimensiones	(LxPxA) mm	800x700x1050	1235x840x1050
Varição de temperaturas / Variation de températures / Variación de temperaturas / Temperature range	°C	+4/+6	4/+6
Volume / Volume / Volumen / Volume	L	150	260
Potência absorvida / Puissance absorbée / Potencia absorbida / Power absorbed	W	611	703
Carga de gás / Charge de gaz / Carga de gas / Gas charge	kg	0,130	0,150
Peso líquido/ Poids net/ Peso neto/ Net weight	Kg	-	-
Gás / Gaz / Gas / Gas		R290	R290
Potência / Puissance / Potencia / Power	W	611	703
Tensão / Tension / Tensión / Tension	V	230	230



Com esgoto  
Avec eaux usées  
Con Aguas residuales  
With Sewage

MODELO/MODÈLE/MODELO/MODEL		DB1000
CÓDIGO / CODE / CÓDIGO / CODE		2058.500
<b>Preço / Prix / Precio / Price</b>	<b>€</b>	<b>2.608,00</b>
Dimensões / Dimensions / Dimensiones	(LxPxA) mm	1060x660x940
Varição de temperaturas / Variation de températures / Variación de temperaturas / Temperature range	°C	+0/+4
Volume / Volume / Volumen / Volume	L	300
Peso líquido/ Poids net/ Peso neto/ Net weight	Kg	60
Tensão / Tension / Tensión / Tension	V	230



MODELO/MODÈLE/MODELO/MODEL		M ML 1200 CG
CÓDIGO / CODE / CÓDIGO / CODE		2525.950
<b>Preço / Prix / Precio / Price</b>	<b>€</b>	<b>3.774,00</b>
Dimensões / Dimensions / Dimensiones	(LxPxA) mm	1200 x 842 x 1852
Temperaturas / Températures / Temperaturas / Temperature	°C	+2/+7
Peso Bruto-líquido/ Poids brut-net/ Peso Bruto-neto/ Gross-net weight	Kg	210-250
Tensão / Tension / Tensión / Tension	V/HZ	230

**MURAI EXPOSITORES PROMOCIONAIS CONGELAÇÃO**  
 MURALS DE PRESENTATION PROMOTIONNELLES CONGÉLATION  
 MURALES EXPOSITORES PROMOCIONALES CONGELACIÓN  
 FREEZING PROMOTIONAL SHOW SERVICES



MODELO/MODÈLE/MODELO/MODEL		ELBA 200
CÓDIGO / CODE / CÓDIGO / CODE		2727.152
<b>Preço / Prix / Precio / Price</b>	<b>€</b>	<b>9.292,00</b>
Dimensões / Dimensions / Dimensiones	(LxPxA) mm	2040 x 915 x 2015
Temperaturas / Températures / Temperaturas / Temperature	°C	-18/-15
Peso Bruto-líquido/ Poids brut-net/ Peso Bruto-neto/ Gross-net weight	Kg	445
Consumo de energia / Consommation energetique / Consumo energia / Energy consumption	kWh/24h	7,25
Potência / Puissance / Potencia / Power	W	2600
Tensão / Tension / Tensión / Tension	V/HZ	230



udi fri

**VITRINES PROMOCIONAIS REFRIGERADAS**  
 VITRINES PROMOTIONNELLES RÉFRIGÉRÉES  
 VITRINAS PROMOCIONALES REFRIGERADAS  
 REFRIGERATED PROMOTIONAL DISPLAYS



**-24°C / +12°C**



MODELO / MODÈLE / MODELO / MODEL	ILHA PANORAMICA	
CÓDIGO / CODE / CÓDIGO / CODE	VD-1040 TN/BT	
	2828.910	
<b>Preço / Prix / Precio / Price</b>	€	<b>2.610,00</b>
Dimensões / Dimensions / Dimensiones	mm	1015x1255x905
Temperatura de funcionamento/Temperatura de funcionamento/Gamme de température/Temperature range	°C	-24 / +12
Peso Líquido-Bruto /Poids Net-Brut /Peso Neto-Bruto /Net-Gross Weight	Kg	127,5/138
Tensão / Tension / Tensión / Tension	V	230



MODELO / MODÈLE / MODELO / MODEL	UDIFRIAL100	
CÓDIGO / CODE / CÓDIGO / CODE	2828.890	
<b>Preço / Prix / Precio / Price</b>	€	<b>1.017,00</b>
Dimensões / Dimensions / Dimensiones	mm	660x460x970
Volume / Volume / Volume / Volume	lt	103
Temperatura de funcionamento/Temperatura de funcionamento/Gamme de température/Temperature range	°C	+2 / +12
Peso Líquido-Bruto /Poids Net-Brut /Peso Neto-Bruto /Net-Gross Weight	Kg	30,5/40,5
Tipo refrigerante / Type de réfrigérant / Tipo refrigerante / Refrigerant type		R600a
Potência / Puissance / Potencia / Power	W	160
Tensão / Tension / Tensión / Tension	V	230





MODELO/MODÈLE/MODELO/MODEL CÓDIGO / CODE / CÓDIGO / CODE	ILHA CALIPSO J 150 OPACA T. NEG 2828.103	
<b>Preço / Prix / Precio / Price</b>	<b>€</b>	<b>2.736,00</b>
Dimensões / Dimensions / Dimensiones	(LxPxA) mm	1550 x 1050 x 865
Volume útil/ Volume itile/ Volumen útil/ Net volume	Lt	150
Temperaturas / Températures / Temperaturas / Temperature	°C	-18/-20
Peso Bruto-líquido/ Poids brut-net/ Peso Bruto-neto/ Gross-net weight	Kg	169
Potência / Puissance / Potencia / Power	W	1300
Tensão / Tension / Tensión / Tension	V/HZ	230



MODELO/MODÈLE/MODELO/MODEL CÓDIGO / CODE / CÓDIGO / CODE	ILHA CALIPSO J 200 OPACA T. NEG 2828.104	
<b>Preço / Prix / Precio / Price</b>	<b>€</b>	<b>3.208,00</b>
Dimensões / Dimensions / Dimensiones	(LxPxA) mm	2050 x 1050 x 865
Volume útil/ Volume itile/ Volumen útil/ Net volume	Lt	200
Temperaturas / Températures / Temperaturas / Temperature	°C	-18/-20
Peso Bruto-líquido/ Poids brut-net/ Peso Bruto-neto/ Gross-net weight	Kg	216
Potência / Puissance / Potencia / Power	W	1370
Tensão / Tension / Tensión / Tension	V/HZ	230



MODELO/MODÈLE/MODELO/MODEL CÓDIGO / CODE / CÓDIGO / CODE	SAMBA J 125 T. NEG 2828.116	
<b>Preço / Prix / Precio / Price</b>	<b>€</b>	<b>2.306,00</b>
Dimensões / Dimensions / Dimensiones	(LxPxA) mm	1240 x 848 x 972
Volume útil/ Volume itile/ Volumen útil/ Net volume	Lt	125
Temperaturas / Températures / Temperaturas / Temperature	°C	-18/-20
Peso Bruto-líquido/ Poids brut-net/ Peso Bruto-neto/ Gross-net weight	Kg	144
Potência / Puissance / Potencia / Power	W	550
Tensão / Tension / Tensión / Tension	V/HZ	230



MODELO/MODÈLE/MODELO/MODEL CÓDIGO / CODE / CÓDIGO / CODE	SAMBA J 125 AN CG+CG 2828.121	
<b>Preço / Prix / Precio / Price</b>	<b>€</b>	<b>6.579,00</b>
Dimensões / Dimensions / Dimensiones	(LxPxA) mm	1240 x 916 x 2004
Peso Bruto-líquido/ Poids brut-net/ Peso Bruto-neto/ Gross-net weight	Kg	365
Potência / Puissance / Potencia / Power	W	950
Tensão / Tension / Tensión / Tension	V/HZ	230
Temperaturas / Températures / Temperaturas / Temperature	°C	-20-22/-18/-20



UDIfri

**VITRINES PROMOCIONAIS CONGELAÇÃO/ CONSERVAÇÃO**

VITRINES PROMOTIONNELLES CONGELATION/CONSERVATION

VITRINAS PROMOCIONALES CONGELACIÓN/CONSERVACIÓN

FREEZING/ CONSERVATION PROMOTIONAL DISPLAYS



**CONGELAÇÃO/FREEZING**



MODELO/MODÈLE/MODELO/MODEL CÓDIGO / CODE / CÓDIGO / CODE	ILHA ROYAL 20 STD 2111.105	
<b>Preço / Prix / Precio / Price</b>	<b>€</b>	<b>2.937,00</b>
Dimensões / Dimensions / Dimensiones	(LxPx) mm	2030 x 1030 x 910
Temperaturas / Températures / Temperaturas / Temperature	°C	-18/-20
Descongelamento / Décongélation/ Descongelación/ Defrost	M/A	A
Volume útil/ Volume itile/ Volumen útil/ Net volume	Lt	500
Peso Bruto-líquido/ Poids brut-net/ Peso Bruto-neto/ Gross-net weight	Kg	155
Potência / Puissance / Potencia / Power	W	960
Tensão / Tension / Tensión / Tension	V/HZ	230

**CONSERVAÇÃO  
CONSERVATION**



MODELO/MODÈLE/MODELO/MODEL CÓDIGO / CODE / CÓDIGO / CODE	ILHA QUARTZ 2000 20/PT STYLFRI 2111.125	
<b>Preço / Prix / Precio / Price</b>	<b>€</b>	<b>2.708,00</b>
Dimensões / Dimensions / Dimensiones	(LxPx) mm	2000 x 1000 x 940
Volume útil/ Volume itile/ Volumen útil/ Net volume	Lt	365
Temperaturas / Températures / Temperaturas / Temperature	°C	+2/+4
Peso Bruto-líquido/ Poids brut-net/ Peso Bruto-neto/ Gross-net weight	Kg	139
Potência / Puissance / Potencia / Power	W	740
Tensão / Tension / Tensión / Tension	V/HZ	230

**CONGELAÇÃO/FREEZING**



MODELO/MODÈLE/MODELO/MODEL CÓDIGO / CODE / CÓDIGO / CODE	VIDEO EXPOSITOR OPEN 20 STD T. NEG 2111.145	
<b>Preço / Prix / Precio / Price</b>	<b>€</b>	<b>3.186,00</b>
Dimensões / Dimensions / Dimensiones	(LxPx) mm	1980 x 820 x 960
Volume útil/ Volume itile/ Volumen útil/ Net volume	Lt	455
Temperaturas / Températures / Temperaturas / Temperature	°C	-18/-20
Peso Bruto-líquido/ Poids brut-net/ Peso Bruto-neto/ Gross-net weight	Kg	145
Potência / Puissance / Potencia / Power	W	730
Tensão / Tension / Tensión / Tension	V/HZ	230

**COMBI**



MODELO/MODÈLE/MODELO/MODEL CÓDIGO / CODE / CÓDIGO / CODE	COMBIMIX 15 CONS+CONG 2111.150	
<b>Preço / Prix / Precio / Price</b>	<b>€</b>	<b>4.918,00</b>
Dimensões / Dimensions / Dimensiones	(LxPx) mm	1390 x 890 x 1875
Temperaturas / Températures / Temperaturas / Temperature	°C	+2/+4/-18-25
Peso Bruto-líquido/ Poids brut-net/ Peso Bruto-neto/ Gross-net weight	Kg	265
Potência / Puissance / Potencia / Power	W	1860
Tensão / Tension / Tensión / Tension	V/HZ	230

**CONSERVAÇÃO  
CONSERVATION**



MODELO/MODÈLE/MODELO/MODEL CÓDIGO / CODE / CÓDIGO / CODE	EXPO 10 LF LACTICINIOS 2111.185	
<b>Preço / Prix / Precio / Price</b>	<b>€</b>	<b>4.294,00</b>
Dimensões / Dimensions / Dimensiones	(LxPx) mm	970 x 830 x 1900
Tipo refrigerante / Type de réfrigérant / Tipo refrigerante / Refrigerant type		R404A
Temperaturas / Températures / Temperaturas / Temperature	°C	+2/+4
Peso Bruto-líquido/ Poids brut-net/ Peso Bruto-neto/ Gross-net weight	Kg	130
Potência / Puissance / Potencia / Power	W	915
Tensão / Tension / Tensión / Tension	V/HZ	230



confirmar disponibilidade  
confirmar la disponibilidad  
confirm the availability

**CONSERVAÇÃO/CONSERVATION**

MODELO/MODÈLE/MODELO/MODEL	ILHA SKYLIGHT 180 WN T.POSIT.	
CÓDIGO / CODE / CÓDIGO / CODE	2828.097	
<b>Preço / Prix / Precio / Price</b>	<b>€</b>	<b>2.422,00</b>
Dimensões / Dimensions / Dimensiones	(LxPxX) mm	1010 x 848 x 895
Volume útil/ Volume itile/ Volumen útil/ Net volume	Lt	180
Temperaturas / Températures / Temperaturas / Temperature	°C	+2/+6
Peso Bruto-líquido/ Poids brut-net/ Peso Bruto-neto/ Gross-net weight	Kg	146
Potência / Puissance / Potencia / Power	W	430
Tensão / Tension / Tensión / Tension	V/HZ	230

**CONGELAÇÃO/FREEZING**

MODELO/MODÈLE/MODELO/MODEL	ILHA SKYLIGHT 180 WN T. NEG	
CÓDIGO / CODE / CÓDIGO / CODE	2828.100	
<b>Preço / Prix / Precio / Price</b>	<b>€</b>	<b>2.422,00</b>
Dimensões / Dimensions / Dimensiones	(LxPxX) mm	1010 x 848 x 895
Volume útil/ Volume itile/ Volumen útil/ Net volume	Lt	180
Temperaturas / Températures / Temperaturas / Temperature	°C	-18/-22
Peso Bruto-líquido/ Poids brut-net/ Peso Bruto-neto/ Gross-net weight	Kg	146
Potência / Puissance / Potencia / Power	W	550
Tensão / Tension / Tensión / Tension	V/HZ	230

**CONGELAÇÃO/FREEZING**

MODELO/MODÈLE/MODELO/MODEL	ILHA SKYLIGHT 350 T. NEG	
CÓDIGO / CODE / CÓDIGO / CODE	2828.101	
<b>Preço / Prix / Precio / Price</b>	<b>€</b>	<b>4.210,00</b>
Dimensões / Dimensions / Dimensiones	(LxPxX) mm	1506 x 1010 x 895
Volume útil/ Volume itile/ Volumen útil/ Net volume	Lt	350
Temperaturas / Températures / Temperaturas / Temperature	°C	-18/-22
Peso Bruto-líquido/ Poids brut-net/ Peso Bruto-neto/ Gross-net weight	Kg	240
Potência / Puissance / Potencia / Power	W	1350
Tensão / Tension / Tensión / Tension	V/HZ	230





udi fri

**MURAI S EXPOSITORES REFRIGERADOS**  
MURALS DE PRESENTATION RÉFRIGÉRÉ  
MURALES EXPOSITORES REFRIGERADOS  
REFRIGERATED SHOW SERVICE MURALS



Mural expositor refrigerado em aço inox;  
Iluminação interior LED; 3 prateleiras;  
Display LED; Cortina noturna; Ventilado.



Exposant mural réfrigéré en acier  
inoxydable;  
Éclairage intérieur à LED; 3 étagères;  
Affichage à LED; Rideau de nuit; Ventilé.



Mural expositor refrigerado en acero  
inoxidable;  
Iluminación interior LED; 3 estantes;  
Display LED; Cortina de noche; Ventilado.



Mural exhibitor refrigerated in stainless  
steel;  
LED indoor lighting; 3 shelves;  
LED display; Night curtain; Ventilated.



MODELO / MODÈLE / MODELO / MODEL	UDMER230	
CÓDIGO / CODE / CÓDIGO / CODE	2829.698	
<b>Preço / Prix / Precio / Price</b>	<b>€</b>	<b>4.464,00</b>
Dimensões / Dimensions / Dimensiones	mm	1000x890x1523
Volume / Volumen / Volume / Volume	lt	380
Comprimento sem laterais / Longueur sans joues / Longitud sin laterales / Length Without end Walls	mm	950
Gás refrigerante / Gaz réfrigérant / Gas refrigerante / Cooling gas		R404a
Temperatura de funcionamento / Gamme de température / Temperatura de funcionamiento / Temperature range	°C	+2+10
Peso Líquido-Bruto / Poids Net-Brut / Peso Neto-Bruto / Net-Gross Weight	Kg	-112
Tensão / Tension / Tensión / Tension	V	230



confirmar disponibilidade  
confirmar la disponibilidad  
confirm the availability

## BUFFET FISH

Com fabricante de gelo ( Em 6 horas = 6 cm gelo. Stop automático)  
 Fabricant de glace (Em 6 horas = 6 cm gelo. Stop automático)  
 Máquina de hacer hielo( Em 6 horas = 6 cm gelo. Stop automático)  
 Ice maker( Em 6 horas = 6 cm gelo. Stop automático)



MODELO / MODÈLE / MODELO / MODEL CÓDIGO / CODE / CÓDIGO / CODE		BUFFET FISH 2090.070
<b>Preço / Prix / Precio / Price</b>	€	<b>10.836,00</b>
Dimensões / Dimensions / Dimensiones	mm	1420x760x1250
Gás refrigerante / Gaz réfrigérant / Gas refrigerante / Refrig. gas		R404A
Descongelação / Décongélation / Descong. / Defrosting	M/A*	M
Refrigeração / Refrigeration / Refrigeracion / Cooling	S/V**	S
Peso Líquido / Poids Net / Peso Neto / Net Weight	Kg	146
Peso Bruto / Poids Brut / Peso Bruto / Gross Weight	Kg	162
Tensão / Tension / Tensión / Tension	V	230

## CARRELINO PASTELARIA

Containers não incluídos  
 Conteneurs non inclus  
 Los contenedores no induidos  
 Containers not induded

gastronorm h=65mm



MODELO / MODÈLE / MODELO / MODEL CÓDIGO / CODE / CÓDIGO / CODE		CARRELINO PASTELARIA 2090.075
<b>Preço / Prix / Precio / Price</b>	€	<b>5.654,00</b>
Dimensões / Dimensions / Dimensiones	mm	1060x480x1070
Temperatura / Température / Temperatura / Temperature	°C	+3/+10
Gás refrigerante / Gaz réfrigérant / Gas refrigerante / Refrig. gas		R134A
Refrigeração / Refrigeration / Refrigeracion / Cooling	S/V**	S
Peso Líquido / Poids Net / Peso Neto / Net Weight	Kg	50
Peso Bruto / Poids Brut / Peso Bruto / Gross Weight	Kg	61
Tensão / Tension / Tensión / Tension	V	230

\* M - Manual | Manuelle | Manual | Manual / A - Automático | Automatique | Automático | Automatic  
 \* S - Estática | Statique | Estática | Static / V - Ventilada | Ventilé | Ventilada | Ventilated



UDIfri

**BUFFETS FRIOS**  
BUFFETS FROID  
BUFFET FRÎO  
COLD BUFFETS



ILHA REFRIGERADA  
ISOLA REFRIGERADA  
ISOLE REFRIGERATE  
REFRIGERATED ISLAND

**Multicolor: sob pedido**  
Multicolore: sur demande  
Multicolor: bajo petición  
Multicolor: on request

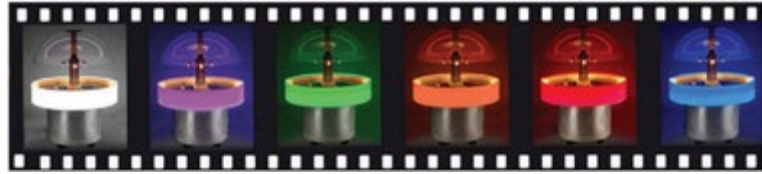

MODELO / MODÈLE / MODELO / MODEL CÓDIGO / CODE / CÓDIGO / CODE		ISOLA BUFFET 2090.055
<b>Preço / Prix / Precio / Price</b>	<b>€</b>	<b>7.534,00</b>
Dimensões / Dimensions / Dimensiones	mm	1280X1680
Temperatura / Température / Temperatura / Temperature	°C	+3/+10
Gás refrigerante / Gaz réfrigérant / Gas refrigerante / Refrig. gas		R452A
Refrigeração / Refrigeration / Refrigeracion / Cooling	S/V**	V
Peso Líquido / Poids Net / Peso Neto / Net Weight	Kg	104
Peso Bruto / Poids Brut / Peso Bruto / Gross Weight	Kg	111
Tensão / Tension / Tensión / Tension	V	230

MODELO / MODÈLE / MODELO / MODEL CÓDIGO / CODE / CÓDIGO / CODE		ISOLA BUFFET GRELHAS INOX 2090.059
<b>Preço / Prix / Precio / Price</b>	<b>€</b>	<b>8.312,00</b>
Dimensões / Dimensions / Dimensiones	mm	1450X1680
Temperatura / Température / Temperatura / Temperature	°C	+3/+10
Gás refrigerante / Gaz réfrigérant / Gas refrigerante / Refrig. gas		R452A
Refrigeração / Refrigeration / Refrigeracion / Cooling	S/V**	V
Peso Líquido / Poids Net / Peso Neto / Net Weight	Kg	104
Peso Bruto / Poids Brut / Peso Bruto / Gross Weight	Kg	111
Tensão / Tension / Tensión / Tension	V	230

MODELO / MODÈLE / MODELO / MODEL CÓDIGO / CODE / CÓDIGO / CODE		ISOLA BUFFET MULTICOLOR 2090.065
<b>Preço / Prix / Precio / Price</b>	<b>€</b>	<b>9.148,00</b>
Dimensões / Dimensions / Dimensiones	mm	1280X1680
Temperatura / Température / Temperatura / Temperature	°C	+3/+10
Gás refrigerante / Gaz réfrigérant / Gas refrigerante / Refrig. gas		R452A
Refrigeração / Refrigeration / Refrigeracion / Cooling	S/V**	V
Peso Líquido / Poids Net / Peso Neto / Net Weight	Kg	104
Peso Bruto / Poids Brut / Peso Bruto / Gross Weight	Kg	111
Tensão / Tension / Tensión / Tension	V	230

ACESSÓRIOS / ACCESSOIRES / ACCESSORIOS / ACCESSORIES CÓDIGO / CODE / CÓDIGO / CODE	COVETE PLÁSTICO 2090.080	PLANO INOX 2090.085
Preço sob consulta / Prix sur demande / Precio a consultar / Price under request		

**Opção covetes ou piano inox, sob pedido**  
Covetes Option ou d'acier plat sur demande  
Opción Covetes o pianos de acero bajo petición  
Option Covetes or flat steel on request



4 Planos inox  
4 plans inox  
4 Planes de acero inoxidable  
4 stainless Plans



10 covetes  
10 covetes  
10 covetes  
10 covetes

\* S - Estática | Statique | Estática | Static / V - Ventilada | Ventilé | Ventilada | Ventilated





udi fri

sob pedido  
sur demande  
bajo pedido  
on request

**BUFFETS FRIO / QUENTE**  
BUFFETS FROID / CHAUD  
BUFFET FRÍO / CALIENTE  
COLD BUFFETS / HOT



BUFFETS FRIOS  
BUFFETS FROID  
BUFFET FRÍO  
COLO BUFFETS



BUFFETS QUENTE  
BUFFETS CHAUD  
BUFFET CALIENTE  
HOT BUFFETS



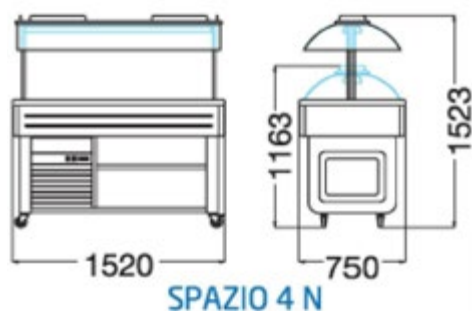

SPAZIO 4 N

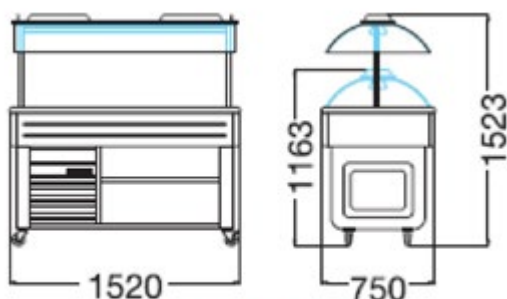

SPAZIO 4 PR

Com mecanismo de elevação da cúpula motorizado / Le mécanisme de monte et descente de la hotte est motorisé / El mecanismo de subida y bajada de la cúpula es motorizado/ The canopy is raised and lowered by electric motor

MODELO / MODÈLE / MODELO / MODEL CÓDIGO / CODE / CÓDIGO / CODE		SPAZIO 4 N 3095.860	SPAZIO 4 PR 3095.822
Preço / Prix / Precio / Price	€	3.279,00	4.888,00
Dimensões / Dimensions / Dimensiones	mm	1520x750x1523	1520x750x1523
Temperatura / Température / Temperatura / Temperature	°C	-	-1/0
Peso Líquido - Bruto / Poids Net - Brut / Peso Neto - Bruto / Net - Gross Weight	Kg	110-126	165-210
Peso Bruto / Poids Brut / Peso Bruto / Gross Weight	Kg	200	850
Tensão / Tension / Tensión / Tension	V	230	230

Estática / Static / Estática / Static

CÓD.	OPCIONAL / OPTIONNEL / OPCIONAL / OPTIONAL	€
3095.872	PORTA-PRATOS CURTO P/TODOS MODELOS SPAZIO 4/6/8	141,00
3095.874	PORTA-PRATOS LONGO SPAZIO 4, PARETE, SERVICE, PESCE	238,00
3095.878	PORTA-PRATOS LONGO P/SPAZIO6/PARETE, SERVICE, PESCE	307,00



**Com mecanismo de elevação da cúpula motorizado/** Le mécanisme de monte et descente de la hotte est motorisé / El mecanismo de subida y bajada de la cúpula es motorizado/ The canopy is raised and lowered by electric motor

**Containers não incluídos /** Conteneurs non inclus / Los contenedores no incluídos/ Containers not included

MODELO / MODÈLE / MODELO / MODEL CÓDIGO / CODE / CÓDIGO / CODE		AGORA 8F 3095.828
<b>Preço / Prix / Precio / Price</b>	€	<b>7.185,00</b>
Dimensões / Dimensions / Dimensiones	mm	1400x1400x1706
Temperatura / Température / Temperatura / Temperature	°C	+4/+10
Gás refrigerante / Gaz réfrigérant / Gas refrigerante / Refrig. gas		R404
Refrigeração / Refrigeration / Refrigeración / Cooling	S/V*	S
Peso Líquido - Bruto / Poids Net - Brut / Peso Neto - Bruto / Net - Gross Weight	Kg	220-240
Potência / Puissance / Potência / Power	W	660
Tensão / Tension / Tensión / Tension	V	230

CÓD.	OPCIONAL / OPTIONNEL / OPCIONAL / OPTIONAL	€
3095.886	PORTA-PRATOS LONGO P/ MODELO AGORA 8	<b>223,00</b>



**confirmar disponibilidade**  
 confirmer la disponibilité  
 confirmar la disponibilidad  
 confirm the availability

\*V = Ventilada / Ventilé / Ventilada / Ventilated | S = Estática / Static / Estática / Static

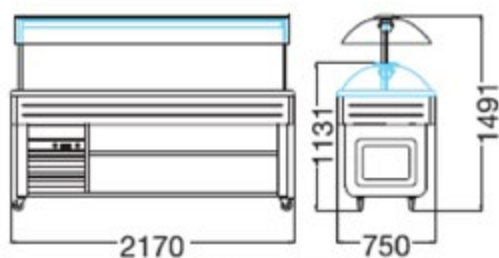
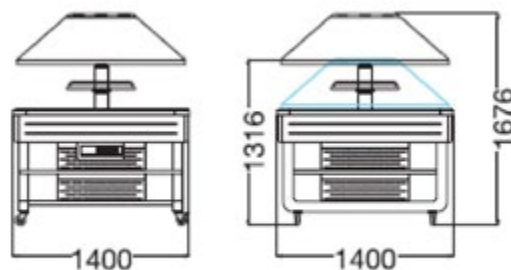
**SPAZIO 6 BM**

**AGORÀ 8 BM**

Com mecanismo de elevação da cúpula motorizado / Le mécanisme de monte et descente de la hotte est motorisé / El mecanismo de subida y bajada de la cúpula es motorizado/ The canopy is raised and lowered by electric motor

MODELO / MODÈLE / MODELO / MODEL		SPAZIO 6 BM	AGORA 8 BM
CÓDIGO / CODE / CÓDIGO / CODE		3095.920	3095.922
<b>Preço / Prix / Precio / Price</b>	€	<b>5.934,00</b>	<b>8.742,00</b>
Dimensões / Dimensions / Dimensiones	mm	2170x750x1491	1400x1400x1576
Temperatura / Température / Temperatura / Temperature	°C	+30/+90	+30/+90
Peso Líquido - Bruto / Poids Net - Brut / Peso Neto - Bruto / Net - Gross Weight	Kg	142-158	187-210
Potência / Puissance / Potência / Power	W	4200	4900
Tensão / Tension / Tensión / Tension	V	400	400

CÓD.	OPCIONAL / OPTIONNEL / OPCIONAL / OPTIONAL	€
3095.960	PORTA-PRATOS CURTO INOX TODOS OS MODELOS SPAZIO4/6/8	<b>160,00</b>
3095.972	PORTA-PRATOS LONGO AGORA 8	<b>205,00</b>







UDIfri

**BUFFETS - QUENTE**  
BUFFETS - CHAUD  
BUFFET - CALIENTE  
BUFFETS - HOT



**Com mecanismo de elevação da cúpula motorizado** / Le mécanisme de monte et descente de la hotte est motorisé / El mecanismo de subida y bajada de la cúpula es motorizado/ The canopy is raised and lowered by electric motor

**Containers não incluídos** / Conteneurs non inclus / Los contenedores no incluídos/ Containers not included

MODELO / MODÈLE / MODELO / MODEL		SPAZIO 4 V	SPAZIO 6V
CÓDIGO / CODE / CÓDIGO / CODE		3095.942	3095.946
<b>Preço / Prix / Precio / Price</b>	<b>€</b>	<b>5.597,00</b>	<b>5.934,00</b>
Dimensões / Dimensions / Dimensiones	mm	1520x750x1491	2170x750x1491
Temperatura / Température / Temperatura / Temperature	°C	+30/+120	+30/+120
Peso Líquido - Bruto / Poids Net - Brut / Peso Neto - Bruto / Net - Gross Weight	Kg	95-115	130-150
Potência / Puissance / Potência / Power	W	2100	3000
Tensão / Tension / Tensión / Tension	V	400	400

CÓD.	OPCIONAL / OPTIONNEL / OPCIONAL / OPTIONAL	€
3095.964	PORTA-PRATOS LONGO INOX T/MODELOS SPAZIO 4	<b>210,00</b>



confirmar disponibilidade  
confirmer la disponibilité  
confirmar la disponibilidad  
confirm the availability



MODELO / MODÈLE / MODELO / MODEL	EB 80G BR	
CÓDIGO / CODE / CÓDIGO / CODE	3095.706	
<b>Preço / Prix / Precio / Price</b>	<b>€</b>	<b>1.378,00</b>
Dimensões / Dimensions / Dimensiones	mm	450x420x810
Volume / Volume / Volume / Volume	lt	65
Temperatura / Température / Temperatura / Temperature	°C	+4/+10
Gás refrigerante / Gaz réfrigérant / Gas refrigerante / Refrig, gas	R404	
Refrigeração / Refrigeration / Refrigeración / Cooling	S/V*	V
Grelhas / Étagères / Estantes / Shelves	nr	2
Peso Líquido - Bruto / Poids Net - Brut / Peso Neto - Bruto / Net - Gross Weight	Kg	39-44
Potência / Puissance / Potência / Power	W	120
Tensão / Tension / Tensión / Tension	V	230



MODELO / MODÈLE / MODELO / MODEL	EB 100S ARG	
CÓDIGO / CODE / CÓDIGO / CODE	3095.710	
<b>Preço / Prix / Precio / Price</b>	<b>€</b>	<b>1.814,00</b>
Dimensões / Dimensions / Dimensiones	mm	498x498x957
Volume / Volume / Volume / Volume	lt	98
Temperatura / Température / Temperatura / Temperature	°C	+4/+10
Gás refrigerante / Gaz réfrigérant / Gas refrigerante / Refrig, gas	R404	
Refrigeração / Refrigeration / Refrigeración / Cooling	S/V*	V
Grelhas / Étagères / Estantes / Shelves	nr	3
Peso Líquido - Bruto / Poids Net - Brut / Peso Neto - Bruto / Net - Gross Weight	Kg	66-76
Potência / Puissance / Potência / Power	W	120
Tensão / Tension / Tensión / Tension	V	230



- +5° +8° +10° +16°C
- +5° +16°C

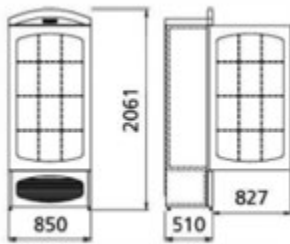

**Fechadura de série / Fermeture à clé de serie / Cierre con llave de serie/ Lock and key standard**

MODELO / MODÈLE / MODELO / MODEL	VN 500W	
CÓDIGO / CODE / CÓDIGO / CODE	3095.402	
<b>Preço / Prix / Precio / Price</b>	<b>€</b>	<b>3.744,00</b>
Dimensões / Dimensions / Dimensiones	mm	850x510x2061
Temperatura / Température / Temperatura / Temperature	°C	+2/+10
Gás refrigerante / Gaz réfrigérant / Gas refrigerante / Refrig. gas		R404
Refrigeração / Refrigeration / Refrigeración / Cooling	S/V*	V
Prateleiras / Étagères / Estantes / Shelves	nr	4
Peso Líquido - Bruto / Poids Net - Brut / Peso Neto - Bruto / Net - Gross Weight	Kg	134-149
Potência / Puissance / Potência / Power	W	400
Tensão / Tension / Tensión / Tension	V	230



confirmar disponibilidade  
confirmer la disponibilité  
confirmar la disponibilidad  
confirm the availability

\*V = Ventilada / Ventilé / Ventilada / Ventilated | S = Estática / Static / Estática / Static

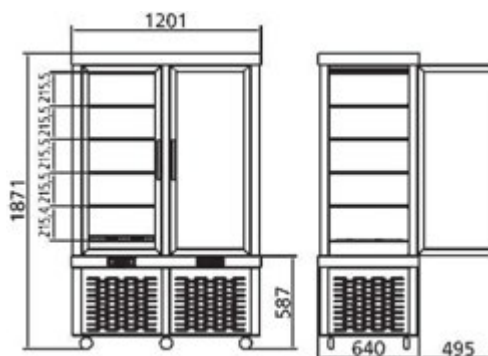

MODELO / MODÈLE / MODELO / MODEL CÓDIGO / CODE / CÓDIGO / CODE		VE 70 BT BR 3095.033	VE 70 BT ARG 3095.032
<b>Preço / Prix / Precio / Price</b>	€	<b>4.951,00</b>	<b>4.951,00</b>
Dimensões / Dimensions / Dimensiones	mm	1201X640X1871	1201X640X1871
Volume / Volume / Volume / Volume	lt	742	742
Temperatura / Température / Temperatura / Temperature	°C	-15/-20	-15/-20
Gás refrigerante / Gaz réfrigérant / Gas refrigerante / Refrig, gas		R404	R404
Refrigeração / Refrigeration / Refrigeración / Cooling	S/V*	S	S
Grelhas / Étagères / Estantes / Shelves	nr	10	10
Peso Líquido - Bruto / Poids Net - Brut / Peso Neto - Bruto / Net - Gross Weight	Kg	209-224	209-224
Potência / Puissance / Potência / Power	W	760	760
Tensão / Tension / Tensión / Tension	V	230	230



MODELO / MODÈLE / MODELO / MODEL CÓDIGO / CODE / CÓDIGO / CODE		VE 70 BT/TNR BR 3095.024	VE 70 BT/TNR ARG 3095.025
<b>Preço / Prix / Precio / Price</b>	€	<b>5.787,00</b>	<b>5.787,00</b>
Dimensões / Dimensions / Dimensiones	mm	1201X640X1871	1201X640X1871
Volume / Volume / Volume / Volume	lt	742	742
Temperatura / Température / Temperatura / Temperature	°C	-15/-20 +2/+10	-15/-20 +2/+10
Gás refrigerante / Gaz réfrigérant / Gas refrigerante / Refrig, gas		R404	R404
Refrigeração / Refrigeration / Refrigeración / Cooling	S/V*	S	S
Grelhas / Étagères / Estantes / Shelves	nr	10	10
Peso Líquido - Bruto / Poids Net - Brut / Peso Neto - Bruto / Net - Gross Weight	Kg	209-224	209-224
Potência / Puissance / Potência / Power	W	760	760
Tensão / Tension / Tensión / Tension	V	230	230

<b>CÓD. OPCIONAL / OPTIONNEL / OPCIONAL / OPTIONAL</b>	€
3095.966 GRELHAS P/ VITRINE VE35 / VE70	<b>54,00</b>



udi fri

VITRINES DE PASTELARIA  
VITRINE DE PÂTISSERIE  
VITRINAS DE PASTELERIA  
PASTRY CABINET

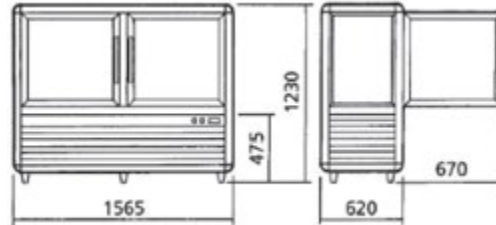

MODELO / MODÈLE / MODELO / MODEL CÓDIGO / CODE / CÓDIGO / CODE		MN 550V BR 3095.166A
<b>Preço / Prix / Precio / Price</b>	€	<b>4.357,00</b>
Dimensões / Dimensions / Dimensiones	mm	1565X620X1230
Volume / Volume / Volume / Volume	lt	539
Temperatura / Température / Temperatura / Temperature	°C	+2/+10
Gás refrigerante / Gaz réfrigérant / Gas refrigerante / Refrig. gas		R404
Refrigeração / Refrigeration / Refrigeración / Cooling	S/V*	V
Grelhas / Étagères / Estantes / Shelves	nr	8
Peso Líquido - Bruto / Poids Net - Brut / Peso Neto - Bruto / Net - Gross Weight	Kg	231-258
Potência / Puissance / Potência / Power	W	540
Tensão / Tension / Tensión / Tension	V	230

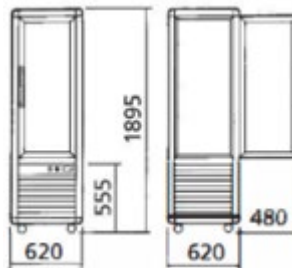

MODELO / MODÈLE / MODELO / MODEL CÓDIGO / CODE / CÓDIGO / CODE		PS 350 R BR 3095.110
<b>Preço / Prix / Precio / Price</b>	€	<b>2.893,00</b>
Dimensões / Dimensions / Dimensiones	mm	620X620X1895
Volume / Volume / Volume / Volume	lt	360
Temperatura / Température / Temperatura / Temperature	°C	+2/+10
Gás refrigerante / Gaz réfrigérant / Gas refrigerante / Refrig. gas		R404
Refrigeração / Refrigeration / Refrigeración / Cooling	S/V*	V
Grelhas / Étagères / Estantes / Shelves	nr	6
Peso Líquido - Bruto / Poids Net - Brut / Peso Neto - Bruto / Net - Gross Weight	Kg	155-170
Potência / Puissance / Potência / Power	W	540
Tensão / Tension / Tensión / Tension	V	230



confirmar disponibilidade  
confirmer la disponibilité  
confirmar la disponibilidad  
confirm the availability

\*V = Ventilada / Ventilé / Ventilada / Ventilated | S = Estática / Static / Estática / Static



**GELATARIA**  
CLACERIE  
HELADERÍA  
ICE-CREAM





Cuba superior com misturador  
 Capacidade cuba: 4 lt  
 Capacidade evaporador : 2lt  
 Painel traseiro com tecnologia led  
 Pannel frontal táctil  
 Produção horária de gelado: 14kg/h  
 Com indicador de temperatura da cuba superior para facil Controlo do produto



Cuvette supérieure avec mélangeur  
 Capacité du réservoir: 4 lt  
 Capacité de l'évaporateur: 2LT  
 Pannel arrière avec technologie LED  
 Pannel de contrôle  
 Production horaire de crème glacée: 14 kg / h  
 Avec indicateur de température de la cuvette supérieure pour un contrôle facile du produit



Cuba superior con mixer  
 Capacidad cuba: 4 lt  
 Capacidad Evaporador: 2lt  
 Panel trasero con tecnologia led  
 Panel de control táctil  
 Producción de helado: 14kg / h  
 Cuba superior con indicador de temperatura para facilitar el control de productos



Top container with mixer  
 Container capacity: 4 lt  
 Evaporator Capacity: 2lt  
 Rear panel with LED technology  
 Tactile panel  
 Hourly production of ice cream: 14kg / h  
 Temperature indicator of the upper bowl for easy control of the product

# Quick-Gel

**14**  
Kg/h



## ALTA PRODUTIVIDADE

Productivité Élevée | Alta Productividad  
 High Productivity

### 1 Cone de 80 gr a cada 20 segundos

1 Cône 80 gr toutes les 20 secondes  
 1 Cone de 80gr a cada 20 segundos  
 1 80Gr cone every 20 seconds

### TRASEIRA

Face Arrière | Parte Trasera | Back



### FRENTE

Face Frontale | Frente | Front



### FECHADURA OPCIONAL

Serrure en option  
 Bloqueo opcional  
 Optional lid locking

FECHADURA



### PAINEL RETRO-ILUMINADO COM TECNOLOGIA LED

LED backlit display  
 Pantalla retro-iluminada con tecnologia LED  
 Ecran rétro-éclairé avec technologie LED



MODELO / MODÈLE / MODELO / MODEL

QUICKGEL

CÓDIGO / CODE / CÓDIGO / CODE

2016.360

Preço / Prix / Precio / Price

€ 8.001,00

Dimensões / Dimensions / Dimensiones / Dimensions

mm 260x570x720

Gás refrigerante / Gaz réfrigérant / Gas refrigerante / Refrigerating gas

R404A

Peso Líquido / Poids Net / Peso Neto / Net Weight

kg 50

Peso Bruto / Poids Brut / Peso Bruto / Gross Weight

kg 55

Tensão / Tension / Tensión / Tension

V 230





**ugolini**  
made in Italy

**MÁQUINAS DE GELADOS**  
MACHINES À GLACES  
MAQUINAS DE HELADOS  
ICE CREAM MACHINE



A máquina de gelados MINIGEL é a inovação mais recente para fazer e distribuir sorvetes. Não só tecnologicamente avançado, mas inteiramente concebido para o utilizador com foco no cliente. Design italiano compacto e elegante, de limpeza fácil e motor de velocidade variável para controle de qualidade. Sistema de congelação da cuba; Sistema de bloqueio da cuba (LK); Indicador de temperatura do produto; Nível de ruído inferior a 70 dB (A).



La machine à crème glacée MINIGEL est la dernière innovation de distribuer la crème glacée. Non seulement technologiquement avancé, mais entièrement conçu pour l'utilisateur avec centre sur le client. Design italien compact et élégant, nettoyage facile et moteur à vitesse variable pour le contrôle de la qualité. Système de congélation de la cuve; Système de blocage de la cuve (LK); Indicateur de température du produit; Niveau sonore inférieure à 70 dB (A).



La máquina de helados MINIGEL es la última innovación para hacer y distribuir helados. No sólo tecnológicamente avanzada, pero diseñado en su totalidad para el usuario con enfoque en el cliente. Diseño italiano compacto y elegante, fácil limpieza y motor de velocidad variable para el control de calidad. Sistema de congelación de la cuba; Sistema de bloqueo de la cuba (LK); Indicador de temperatura del producto; Nivel del ruido inferior a 70 dB (A).



MINIGEL is the latest innovation from machine for making and dispensing ice cream. Not just technologically advanced, but designed entirely for the customer-focused operator. Compact elegant and Italian design, easy cleaning and variable speed motor for quality control. Bowl de-frosting system; Bowl locking system(LK); Product temperature display; Noise level lower than 70 dB (A).



MODELO / MODÈLE / MODELO / MODEL	MINIGEL 1	MINIGEL 1 LK
CÓDIGO / CODE / CÓDIGO / CODE	2016.222	2016.224
<b>Preço / Prix / Precio / Price</b>	<b>€ 2.733,00</b>	<b>2.985,00</b>
Dimensões / Dimensions / Dimensiones / Dimensions	mm 195x480x615	195x480x615
Capacidade cuba / Cap cuve / Cap. cuba / Vat capacity	lt 6	6
Peso Líquido-Bruto / Poids Net-Brut / Peso Neto-Bruto / Net-Gross Weight	kg 25/27	25/27
Tensão / Tension / Tension / Tension	V 230	230



MODELO / MODÈLE / MODELO / MODEL	MINIGEL 2	MINIGEL 2 LK
CÓDIGO / CODE / CÓDIGO / CODE	2016.226	2016.228
<b>Preço / Prix / Precio / Price</b>	<b>€ 5.022,00</b>	<b>5.510,00</b>
Dimensões / Dimensions / Dimensiones / Dimensions	mm 395x480x615	395x480x615
Capacidade cuba / Cap cuve / Cap. cuba / Vat capacity	lt 6+6	6+6
Peso Líquido-Bruto / Poids Net-Brut / Peso Neto-Bruto / Net-Gross Weight	kg 45/48	45/48
Tensão / Tension / Tension / Tension	V 230	230



MODELO / MODÈLE / MODELO / MODEL	MINIGEL 3	MINIGEL 3 LK
CÓDIGO / CODE / CÓDIGO / CODE	2016.230	2016.232
<b>Preço / Prix / Precio / Price</b>	<b>€ 7.458,00</b>	<b>8.179,00</b>
Dimensões / Dimensions / Dimensiones / Dimensions	mm 595x480x615	595x480x615
Capacidade cuba / Cap cuve / Cap. cuba / Vat capacity	lt 6+6+6	6+6+6
Peso Líquido-Bruto / Poids Net-Brut / Peso Neto-Bruto / Net-Gross Weight	kg 61/64	61/64
Tensão / Tension / Tension / Tension	V 230	230



 Máquina construída com materiais de grande impacto estético, robusta e soluções tecnológicas ímpares permitindo produzir diferentes produtos: gelado, Milkshake; gelado de iogurte, bebidas frias; Ecrã tátil de 7"; Sistema de controlo avançado "GTECH Incodis 3.0 e controlo remoto; Sistema de produção por gravidade; Tratamento térmico "GTECH HT e GTECH Healthy", reduz os ciclos de lavagem garantindo os requisitos do protocolo de higiene; Sistema inversor garante fiabilidade, eficiência e qualidade no gelado. Uma combinação perfeita de forma e funcionalidade; funções standard através do painel frontal, máxima ergonomia; fluxo de ar ascendente podendo ser instalada mesmo em locais estreitos;

 Machine construite avec des matériaux d'un grand impact esthétique, des solutions technologiques robustes et uniques permettant de produire différents produits: crème glacée, milkshake; crème glacée au yogourt, boissons fraîches. Système de production par gravité. Le traitement thermique « GTECH HT et GTECH Healthy », réduit les cycles de lavage en assurant les exigences du protocole d'hygiène. Le système Inverter assure la fiabilité, l'efficacité et la qualité de la crème glacée. Une combinaison parfaite de forme et de fonctionnalité. Fonctions standard à travers le panneau avant et ergonomie maximale; Le flux d'air ascendant peut être installé même dans des endroits étroits. Écran tactile de 7" avec système de contrôle avancé GTECH Incodis 3.0 et télécommande.

 Máquina construída con materiales de gran impacto estético, soluciones tecnológicas robustas y únicas que permiten producir diferentes productos: helados, batidos; helado de yogur, bebidas frías. Sistema de producción por gravedad. El tratamiento térmico "GTECH HT y GTECH Healthy", reduce los ciclos de lavado garantizando los requisitos del protocolo de higiene. El sistema inversor garantiza fiabilidad, eficiencia y calidad en helados. Una combinación perfecta de forma y funcionalidad. Funciones estándar a través del panel frontal y máxima ergonomía; El flujo de aire ascendente se puede instalar incluso en lugares estrechos. Pantalla táctil de 7" con avanzado sistema de control GTECH Incodis 3.0 y mando a distancia.

 Machine built with materials of great aesthetic impact, robust and unique technological solutions allowing to produce different products: ice cream, milkshake; yogurt ice cream, cold drinks. Gravity production system. Heat treatment "GTECH HT and GTECH Healthy", reduces washing cycles ensuring the requirements of the hygiene protocol. Inverter system ensures reliability, efficiency and quality in ice cream. A perfect combination of form and functionality. Standard functions through the front panel and maximum ergonomics; Upward airflow can be installed even in narrow locations. 7" touchscreen with advanced GTECH Incodis 3.0 control system and remote control.



**NOVO  
NOUVEAU  
NUEVO  
NEW**



MODELO / MODÈLE / MODELO / MODEL	GIOTTO 11	GIOTTO 12
CÓDIGO / CODE / CÓDIGO / CODE	2061.990	CONSULTAR
<b>Preço / Prix / Precio / Price</b>	€ <b>CONSULTAR</b>	<b>CONSULTAR</b>
Dimensões / Dimensions / Dimensiones / Dimensions	mm 300x705x780	400x880x814
Capacidade cuba / Cap cuve / Cap. cuba / Vat capacity	lt 6,5	18
Capacidade cilindro / Cap. cylindre / Cap. cilindro / Cylinder capacity	lt 1,5	3,2
Gelado / Glace / Helado / Ice Cream	kg/h 18	30
Arrefecimento / Refroidissement / Arrefecimento / Arrefecimento	AR	AR
Peso Líquido-Bruto / Poids Net-Brut / Peso Neto-Bruto / Net-Gross Weight	kg 85-	125-
Potência / Puissance / Potência / Power	kW 2,7	3,2
Tensão / Tension / Tensión / Tension	V 230	230



Modelos electromecânicos ou electrónicos (In.Co.dis) de balcão ou verticais, simples ou de duplos sabores, com sistema de gravidade para a produção de gelado soft, gelado expresso, frozen yogurt e confeitaria fria. Capacidade de produção base do cilindro de congelação de 1,7 litros. Ideal para espaços reduzidos e de fácil posicionamento.

ALIMENTAÇÃO POR GRAVIDADE



Modèles électromécaniques ou électroniques (In.Co.dis), comptoir ou verticaux, simple ou doubles avec système à gravité pour la production de crème glacée molle, crème glacée espresso, yogourt glacé et pâtisserie froid. La capacité de production base du cylindre de congélation de 1,7 litres. Idéal pour les petits espaces et positionnement facile.

ALIMENTATION PAR GRAVITÉ



Modelos electromecánicos o electrónicos (In.Co.dis), mostrador o verticales, sabores simples o dobles con sistema de gravedad para la producción de helado suave, helado expresso, yogur helado y pastelería fría. Capacidad de producción base del cilindro de congelación de 1,7 litros. Ideal para espacios pequeños y fácil colocación.

ALIMENTACIÓN POR GRAVEDAD



Electromechanical or electronic models (In.Co.dis), counter or vertical, single or double flavors, with gravity to produce soft ice cream system, espresso ice cream, frozen yogurt and cold bakery. Base production capacity of the freezing cylinder 1.7 liter. GreAt Quality in reduced spaces

GRAVITY FEEDING

## E.Co.S.



### Sistema de controlo LCD

Système de contrôle LCD  
Sistema de control LCD  
LCD control system



MODELO / MODÈLE / MODELO / MODEL	BC EASY1GR 230V	
CÓDIGO / CODE / CÓDIGO / CODE	2061.900A	
<b>Preço / Prix / Precio / Price</b>	€	<b>10.227,00</b>
Dimensões / Dimensions / Dimensiones / Dimensions	mm	460x690x805
Capacidade cuba / Cap cuve / Cap. cuba / Vat capacity	Lt	12
Cones (75 gr) / Cônes / Conos / Cones	nr	230
Gelado / Glace / Helado / Ice Cream	kg/h	17
Arrefecimento / Refroidissement / Arrefecimento / Arrefecimento		AR
Peso Líquido-Bruto / Poids Net-Brut / Peso Neto-Bruto / Net-Gross Weight	kg	105-115
Potência / Puissance / Potência / Power	kW	1,8
Tensão / Tension / Tensión / Tension	V	230

**E.Co.S.**

**Sistema de controlo LCD**

 Système de contrôle LCD  
 Sistema de control LCD  
 LCD control system

(2 SABORES + MIX)

**b**

MODELO / MODÈLE / MODELO / MODEL		BC EASY2GR 230V	BC EASY2GR 400V
CÓDIGO / CODE / CÓDIGO / CODE		2061.916A	2061.918A
<b>Preço / Prix / Precio / Price</b>	<b>€</b>	<b>15.569,00</b>	<b>15.447,00</b>
Dimensões / Dimensions / Dimensiones / Dimensions	mm	530x770x860	530x770x860
Capacidade cuba / Cap cuve / Cap. cuba / Vat capacity	lt	12+12	12+12
Cones / Glace / Helado / Ice Cream	nr (75 gr)	350	350
Gelado / Glace / Helado / Ice Cream	kg/h	26	26
Arrefecimento / Refroidissement / Arrefecimento / Arrefecimento		AR	AR
Peso Líquido / Poids Net / Peso Neto / Net Weight	kg	170-190	170-190
Potência / Puissance / Potência / Power	kW	3,1	3,1
Tensão / Tension / Tension / Tension		230	400

(2 SABORES + MIX)

**m**

MODELO / MODÈLE / MODELO / MODEL		BV EASY2GR 230V	BV EASY2GR 400V
CÓDIGO / CODE / CÓDIGO / CODE		2061.932A	2061.934A
<b>Preço / Prix / Precio / Price</b>	<b>€</b>	<b>16.540,00</b>	<b>16.540,00</b>
Dimensões / Dimensions / Dimensiones / Dimensions	mm	530x770x1480	530x770x1480
Capacidade cuba / Cap cuve / Cap. cuba / Vat capacity	lt	12+12	12+12
Cones / Glace / Helado / Ice Cream	nr (75 gr)	440	440
Gelado / Glace / Helado / Ice Cream	kg/h	33	33
Arrefecimento / Refroidissement / Arrefecimento / Arrefecimento		AR	AR
Peso Líquido / Poids Net / Peso Neto / Net Weight	kg	211-226	211-226
Potência / Puissance / Potência / Power	kW	3,1	3,1
Tensão / Tension / Tension / Tension		230	400

(2 SABORES + MIX)

**m**
**In.Co.Di.S**

**Sistema interativo com touchscreen**  
 Système interactif avec écran tactile  
 Sistema de pantalla táctil interactiva  
 Interactive system with touchscreen

**HTG**

 Tratamento térmico - Gravidade + Pasteurizador  
 Traitement thermique - gravité + Pasteurisateur  
 Tratamiento térmico - gravedad + Pasteurizador  
 Heat Treatment - Gravity + Pasteurizer

MODELO / MODÈLE / MODELO / MODEL		BV 261 HTG GR 3 SAIDAS
CÓDIGO / CODE / CÓDIGO / CODE		2061.944
<b>Preço / Prix / Precio / Price</b>	<b>€</b>	<b>23.176,00</b>
Dimensões / Dimensions / Dimensiones / Dimensions	mm	555x774x1472
Capacidade cuba / Cap cuve / Cap. cuba / Vat capacity	lt	12+12
Cones / Glace / Helado / Ice Cream	nr (75 gr)	440
Gelado / Glace / Helado / Ice Cream	kg/h	33
Arrefecimento / Refroidissement / Arrefecimento / Arrefecimento		AR
Peso Líquido / Poids Net / Peso Neto / Net Weight	kg	200-215
Potência / Puissance / Potência / Power	kW	3,1
Tensão / Tension / Tension / Tension		400



Com sistema de bomba para insuflação (aumento de volume em 40%).



Avec système de pompe pour l'insuflation (augmentation de volume en 40%)



Con sistema de bomba para insuflación (aumento del volumen en 40%)



With pump system for inflation (increase in volume by 40%).

**E.Co.S.**



Sistema de controlo LCD  
Système de contrôle LCD  
Sistema de control LCD  
LCD control system

( 1 Sabor)



MODELO / MODÈLE / MODELO / MODEL	BC EASY1PM 230V	
CÓDIGO / CODE / CÓDIGO / CODE	2061.904A	
<b>Preço / Prix / Precio / Price</b>	<b>€</b>	<b>12.372,00</b>
Dimensões / Dimensions / Dimensiones / Dimensions	mm	460x690x 805
Capacidade cuba / Cap cuve / Cap. cuba / Vat capacity	lt	9
Cones (75 gr) / Cônes / Conos / Cones	nr	250
Gelado / Glace / Helado / Ice Cream	kg/h	19
Arrefecimento / Refroidissement / Arrefecimento / Arrefecimento		AR
Peso Líquido-Bruto / Poids Net-Brut / Peso Neto-Bruto / Net-Gross Weight	kg	110
Potência / Puissance / Potência / Power	kW	1,8
Tensão / Tension / Tension / Tension	V	230

( 2 Sabores + Mix)



MODELO / MODÈLE / MODELO / MODEL	BC EASY2PM 230V	BC EASY2PM 400V	
CÓDIGO / CODE / CÓDIGO / CODE	2061.920A	2061.922A	
<b>Preço / Prix / Precio / Price</b>	<b>€</b>	<b>19.534,00</b>	<b>19.332,00</b>
Dimensões / Dimensions / Dimensiones / Dimensions	mm	530x770x 860	530x770x 860
Capacidade cuba / Cap cuve / Cap. cuba / Vat capacity	lt	9+9	9+9
Cones (75 gr) / Cônes / Conos / Cones	nr	390	390
Gelado / Glace / Helado / Ice Cream	kg/h	29	29
Arrefecimento / Refroidissement / Arrefecimento / Arrefecimento		AR	AR
Peso Líquido-Bruto / Poids Net-Brut / Peso Neto-Bruto / Net-Gross Weight	kg	170	170
Potência / Puissance / Potência / Power	kW	3,1	3,1
Tensão / Tension / Tension / Tension	V	230	400



**E.Co.S.**

Sistema de controlo LCD  
 Système de contrôle LCD  
 Sistema de control LCD  
 LCD control system



( 2 Sabores + Mix)



MODELO / MODÈLE / MODELO / MODEL		BV EASY2PM 230V	BV EASY2PM 400V
CÓDIGO / CODE / CÓDIGO / CODE		2061.936A	2061.938A
<b>Preço / Prix / Precio / Price</b>	€	<b>20.343,00</b>	<b>20.343,00</b>
Dimensões / Dimensions / Dimensiones / Dimensions	mm	530x770x1480	530x770x1480
Capacidade cuba / Cap cuve / Cap. cuba / Vat capacity	lt	9+9	9+9
Cones (75 gr) / Cônes / Conos / Cones	nr	480	480
Gelado / Glace / Helado / Ice Cream	kg/h	36	36
Arrefecimento / Refroidissement / Arrefecimento / Arrefecimento		AR	AR
Peso Líquido-Bruto / Poids Net-Brut / Peso Neto-Bruto / Net-Gross Weight	kg	200	200
Potência / Puissance / Potência / Power	kW	3,1	3,1
Tensão / Tension / Tension / Tension	V	230	400

**In.Co.Di.S**

Sistema interativo com touchscreen  
 Système interactif avec écran tactile  
 Sistema de pantalla táctil interactiva  
 Interactive system with touchscreen



MODELO / MODÈLE / MODELO / MODEL		ETOILE GEL PLUS PM 400V AR
CÓDIGO / CODE / CÓDIGO / CODE		2061.972
<b>Preço / Prix / Precio / Price</b>	€	<b>33.940,00</b>
Dimensões / Dimensions / Dimensiones / Dimensions	mm	1540x700x840
Capacidade cuba / Cap cuve / Cap. cuba / Vat capacity	lt	14(11)
Cones (75 gr) / Cônes / Conos / Cones	nr	800/930
Gelado / Glace / Helado / Ice Cream	kg/h	60(70)
Arrefecimento / Refroidissement / Arrefecimento / Arrefecimento		AR
Peso Líquido-Bruto / Poids Net-Brut / Peso Neto-Bruto / Net-Gross Weight	kg	310-
Potência / Puissance / Potência / Power	kW	6
Tensão / Tension / Tension / Tension	V	400



UDIfri

**PRODUTORES DE GELADO MANUAL**  
 PRODUCTEURS DE GLACES MANUELLES  
 PRODUCTORES DE HELADOS MANUALES  
 COUNTERTOP MANUAL ICE-CREAM MAKERS



## MANUAIS / MANUELS / MANUALES / MANUAL

Produção para temperatura ambiente de 15°C e temp. líquidos 4°C  
 Production pour la température ambiante de 15°C et pour la température liquide 4°C  
 Producción para temperatura ambiente de 15°C y para la temperatura líquida 4°C  
 Production for ambient temperature of 15°C and for liquid temperature 4°C.



**b**

MODELO / MODÈLE / MODELO / MODEL		BTM 5A
CÓDIGO / CODE / CÓDIGO / CODE		2061.485
<b>Preço / Prix / Precio / Price</b>	<b>€</b>	<b>4.718,00</b>
Dimensões / Dimensions / Dimensiones / Dimensions	mm	435x570x491+24
Gelado Ciclo / Glace Cycle / Helado Ciclo / Ice Cream Cycle	Ciclo/Lt Min	1
Sorvete Ciclo / Sorbet Cycle / Sorbete Ciclo / Sherbet Cycle	Ciclo/Lt Min	1,5
Granizado Ciclo / En grains Cycle / Granizado Ciclo / Granita Cycle	Ciclo/Lt Min	4
Produção de Gelado / Glace / Helado / Ice Cream /	Lt/h	5,5
Produção de Sorvete / Sorbet / Sorbete / Sherbet /	Lt/h	7,5
Produção de Granizado / En grains / Granizado / Granita	Lt/h	12
Peso Líquido-Bruto / Poids Net-Brut / Peso Neto-Bruto / Net-Gross Weight	kg	40-50
Potência / Puissance / Potência / Power	w	700
Tensão / Tension / Tension / Tension	V	230



**b**

MODELO / MODÈLE / MODELO / MODEL		BTM 10A
CÓDIGO / CODE / CÓDIGO / CODE		2061.490
<b>Preço / Prix / Precio / Price</b>	<b>€</b>	<b>6.413,00</b>
Dimensões / Dimensions / Dimensiones / Dimensions	mm	435x570x491+24
Gelado Ciclo / Glace Cycle / Helado Ciclo / Ice Cream Cycle	Ciclo/Lt Min	2
Sorvete Ciclo / Sorbet Cycle / Sorbete Ciclo / Sherbet Cycle	Ciclo/Lt Min	3
Granizado Ciclo / En grains Cycle / Granizado Ciclo / Granita Cycle	Ciclo/Lt Min	4
Produção de Gelado / Glace / Helado / Ice Cream /	Lt/h	10
Produção de Sorvete / Sorbet / Sorbete / Sherbet /	Lt/h	14
Produção de Granizado / En grains / Granizado / Granita	Lt/h	14
Peso Líquido-Bruto / Poids Net-Brut / Peso Neto-Bruto / Net-Gross Weight	kg	45-55
Potência / Puissance / Potência / Power	w	1 100
Tensão / Tension / Tension / Tension	V	230



**m**

MODELO / MODÈLE / MODELO / MODEL		BFM 10A
CÓDIGO / CODE / CÓDIGO / CODE		2061.492
<b>Preço / Prix / Precio / Price</b>	<b>€</b>	<b>7.026,00</b>
Dimensões / Dimensions / Dimensiones / Dimensions	mm	435x710x950+130
Gelado Ciclo / Glace Cycle / Helado Ciclo / Ice Cream Cycle	Ciclo/Lt Min	2
Sorvete Ciclo / Sorbet Cycle / Sorbete Ciclo / Sherbet Cycle	Ciclo/Lt Min	3
Granizado Ciclo / En grains Cycle / Granizado Ciclo / Granita Cycle	Ciclo/Lt Min	4
Produção de Gelado / Glace / Helado / Ice Cream /	Lt/h	10
Produção de Sorvete / Sorbet / Sorbete / Sherbet /	Lt/h	14
Produção de Granizado / En grains / Granizado / Granita	Lt/h	14
Peso Líquido-Bruto / Poids Net-Brut / Peso Neto-Bruto / Net-Gross Weight	kg	66-79
Potência / Puissance / Potência / Power	w	1 100
Tensão / Tension / Tension / Tension	V	230

**b** bancada  
 plain de travail  
 encimera  
 worktop

**m** móvel  
 mobile  
 móvil  
 mobile

A - Arrefecimento a ar / Refroidissement à air / Enfriamiento por aire / Air-cooling system



Painel de comandos ergonómico; Display gráfico multilingual; 52 programas que podem incluir: Misturar, bater, lavagem; Permite seleccionar o ciclo ideal a mistura correspondente( leite, fruta); Programas livres : Densidade, Velocidade do agitador



Panneau de commande ergonomique ; Affichage graphique multilingue ; 52 programmes pouvant inclure : Mix, battre, laver ; Permet de sélectionner le cycle idéal correspondant de mélange (lait, fruits) ; Programmes gratuits : densité, vitesse de l'agitateur



Panel de Control ergonómico; Visualizador gráfico multilingüe; 52 programas que pueden incluir: mezclar, batir, lavar; Le permite seleccionar el ciclo ideal correspondiente mezcla (leche, fruta); Gratis programas: densidad, velocidad del agitador



Ergonomic Control Panel; Multilingual graphic display; 52 programs that can include: Mix, beat, wash; Allows you to select the ideal cycle corresponding mixture (milk, fruit); Free programs: density, speed of agitator



MODELO / MODÈLE / MODELO / MODEL	BTX 150A	
CÓDIGO / CODE / CÓDIGO / CODE	2061.496	
<b>Preço / Prix / Precio / Price</b>	<b>€</b>	<b>9.986,00</b>
Dimensões / Dimensions / Dimensiones / Dimensions	mm	435x592x571+24
Gelado Ciclo / Glace Cyde / Helado Ciclo / Ice Cream Cyde	Ciclo/Lt Min/ Máx	1-2
Produção de Gelado / Glace / Helado / Ice Cream	Lt/h	15
Peso Líquido-Bruto / Poids Net-Brut / Peso Neto-Bruto / Net-Gross Weight	kg	55-68
Potência / Puissance / Potência / Power	W	1600
Tensão / Tension / Tensión / Tension	V	230



MODELO / MODÈLE / MODELO / MODEL	BFX150A	
CÓDIGO / CODE / CÓDIGO / CODE	2061.502	
<b>Preço / Prix / Precio / Price</b>	<b>€</b>	<b>10.690,00</b>
Dimensões / Dimensions / Dimensiones / Dimensions	mm	435x592x944+130
Gelado Ciclo / Glace Cyde / Helado Ciclo / Ice Cream Cyde	Ciclo/Lt Min/ Máx	2
Produção de Gelado / Glace / Helado / Ice Cream	Lt/h	15
Peso Líquido-Bruto / Poids Net-Brut / Peso Neto-Bruto / Net-Gross Weight	kg	69-79
Potência / Puissance / Potência / Power	W	1600
Tensão / Tension / Tensión / Tension	V	230



MODELO / MODÈLE / MODELO / MODEL	BFX 400A	BFX 400W	BFX 400AW	
CÓDIGO / CODE / CÓDIGO / CODE	2061.514	2061.515	2061.516	
<b>Preço / Prix / Precio / Price</b>	<b>€</b>	<b>17.926,00</b>	<b>17.926,00</b>	<b>18.474,00</b>
Dimensões / Dimensions / Dimensiones / Dimensions	mm	600x850x1205+130	600x850x1205+130	600x850x1205+130
Gelado Ciclo / Glace Cyde / Helado Ciclo / Ice Cream Cyde	Ciclo/Lt Min/ Máx	2-5	2-5	2-5
Produção de Gelado / Glace / Helado / Ice Cream	Lt/h	35	35	35
Peso Líquido-Bruto / Poids Net-Brut / Peso Neto-Bruto / Net-Gross Weight	kg	180-197	180-197	180-197
Potência / Puissance / Potência / Power	W	4000	4000	4000
Tensão / Tension / Tensión / Tension	V	400	400	400





UDIfri

**PRODUTORES DE GELADO COM EXTRAÇÃO AUTOMÁTICA**

PRODUCTEURS DE GLACES MANUELLES ET AUTOMATIQUES

PRODUCTORES DE HELADOS MANUALES Y AUTOMÁTICOS

MANUAL AND AUTOMATIC ICE-CREAM MAKERS



MODELO / MODÈLE / MODELO / MODEL		BFX 600A	BFX 600-AW
CÓDIGO / CODE / CÓDIGO / CODE		2061.520	2061.517
<b>Preço / Prix / Precio / Price</b>	€	<b>23.845,00</b>	<b>24.562,00</b>
Dimensões / Dimensions / Dimensiones	mm	600x850x 1205+130	600x850x 1205+130
Gelado Ciclo / Glace Cyde / Helado Ciclo / Ice Cream Cyde	Ciclo/Lt Min/Máx	2-7	2-7
Produção de Gelado / Glace / Helado / Ice Cream	Lt/h	60	60
Peso Líquido-Bruto / Poids Net-Brut / Peso Neto-Bruto / Net-Gross Weight	kg	207-224	207-224
Potência / Puissance / Potência / Power	W	5800	5800
Tensão / Tension / Tensión / Tension	V	400	400



MODELO / MODÈLE / MODELO / MODEL		BFX1000W	BFX1000A
CÓDIGO / CODE / CÓDIGO / CODE		2061.519B	2061.519A
<b>Preço / Prix / Precio / Price</b>	€	<b>34.850,00</b>	<b>38.318,00</b>
Dimensões / Dimensions / Dimensiones / Dimensions	mm	600x850x 1205+130	600x850x 1205+130
Gelado Ciclo / Glace Cyde / Helado Ciclo / Ice Cream Cyde	Ciclo/Lt Min/Máx	7	7
Produção de Gelado / Glace / Helado / Ice Cream	Lt/h	60	60
Peso Líquido-Bruto / Poids Net-Brut / Peso Neto-Bruto / Net-Gross Weight	kg	300-320	300-320
Potência / Puissance / Potência / Power	W	5800	5800
Tensão / Tension / Tensión / Tension	V	400	400

Modelo arrefecimento a água sob consulta / Modèle refroidissement à eau disponible  
Modelo enfriamiento por água disponible / Water cooling model available

A - Arrefecimento a ar / Refroidissement à air / Enfriamiento por aire / Air-cooling system  
W - Arrefecimento a água / Refroidissement à Eau / Enfriamiento por agua / Water-cooling system  
AW - Arrefecimento misto / Refroidissement mixte / Enfriamiento mixto / Mixed Cooling



móvel  
mobile  
móvil  
mobile

# Máquinas **3 em 1**

**b**

MODELO / MODÈLE / MODELO / MODEL		RT51A
CÓDIGO / CODE / CÓDIGO / CODE		2061.532
<b>Preço / Prix / Precio / Price</b>	<b>€</b>	<b>11.498,00</b>
Dimensões / Dimensions / Dimensiones / Dimensions	mm	435x592x 571H+24
Gelado Ciclo / Glace Cycle / Helado Ciclo / Ice Cream Cycle	Ciclo Lt Min/ Máx	1-2
Produção de Gelado / Glace / Helado / Ice Cream	Lt/h	15
Ciclo térmico / Cycle thermique / Ciclo térmico / Thermal Cycle	lt/ min	5/50
Peso Líquido-Bruto / Poids Net-Brut / Peso Neto-Bruto / Net-Gross Weight	kg	58-68
Potência / Puissance / Potência / Power	W	2000
Tensão / Tension / Tension / Tension	V	230

**m**

MODELO / MODÈLE / MODELO / MODEL		R51 A
CÓDIGO / CODE / CÓDIGO / CODE		2061.536
<b>Preço / Prix / Precio / Price</b>	<b>€</b>	<b>12.268,00</b>
Dimensões / Dimensions / Dimensiones / Dimensions	mm	435x592x944 +130
Gelado Ciclo / Glace Cycle / Helado Ciclo / Ice Cream Cycle	Ciclo Lt Min/ Máx	1-2
Produção de Gelado / Glace / Helado / Ice Cream	Lt/h	15
Ciclo térmico / Cycle thermique / Ciclo térmico / Thermal Cycle	lt/ min	5/50
Peso Líquido-Bruto / Poids Net-Brut / Peso Neto-Bruto / Net-Gross Weight	kg	71-84
Potência / Puissance / Potência / Power	W	2000
Tensão / Tension / Tension / Tension	V	230

**m**

MODELO / MODÈLE / MODELO / MODEL		R151 AW
CÓDIGO / CODE / CÓDIGO / CODE		2061.547
<b>Preço / Prix / Precio / Price</b>	<b>€</b>	<b>34.250,00</b>
Dimensões / Dimensions / Dimensiones / Dimensions	mm	600x850x 1205+130
Gelado Ciclo / Glace Cycle / Helado Ciclo / Ice Cream Cycle	Ciclo Lt Min/ Máx	2-4
Produção de Gelado / Glace / Helado / Ice Cream	Lt/h	20
Ciclo térmico / Cycle thermique / Ciclo térmico / Thermal Cycle	lt/ min	15/60
Peso Líquido-Bruto / Poids Net-Brut / Peso Neto-Bruto / Net-Gross Weight	kg	215-232
Potência / Puissance / Potência / Power	W	4800
Tensão / Tension / Tension / Tension	V	400



UDIfri

**PASTEURIZADORES E COZEDOR DE CREME**  
 PASTEURISATEURS CUISINIÈRE DE CRÈME  
 PRODUCTORES PASTEURIZADOR COCEDOR DE CREMA  
 PASTEURIZER PRODUCER CREAM COOKERS



# Máquina 2 em 1



PASTEURIZADOR  
 PASTEURISATEUR  
 PASTEURIZADOR  
 PASTEURIZER

MODELO / MODÈLE / MODELO / MODEL	P400 AW	
CÓDIGO / CODE / CÓDIGO / CODE	2061.560	
<b>Preço / Prix / Precio / Price</b>	<b>€</b>	<b>19.960,00</b>
Dimensões / Dimensions / Dimensiones / Dimensions	mm	600x850x 1205+130
Ciclo térmico / Cycle thermique / Ciclo térmico / Thermal Cycle	lt/ min	40/120min
Peso Líquido-Bruto / Poids Net-Brut / Peso Neto-Bruto / Net-Gross Weight	kg	145-162
Potência / Puissance / Potência / Power	W	3450
Tensão / Tension / Tension / Tension	V	400



PASTEURIZADOR E COZEDOR DE CREME  
 PASTEURISATEUR CUISINIÈRE DE CRÈME  
 PASTEURIZADOR COCEDOR DE CREMA  
 PASTEURIZER CREAM COOKER

MODELO / MODÈLE / MODELO / MODEL	R400 A	R400 W
CÓDIGO / CODE / CÓDIGO / CODE	2061.550	2061.555
<b>Preço / Prix / Precio / Price</b>	<b>€ 28.735,00</b>	<b>28.735,00</b>
Dimensões / Dimensions / Dimensiones / Dimensions	mm 600x850x 1205+130	600x850x 1205+130
Ciclo térmico / Cycle thermique / Ciclo térmico / Thermal Cycle	lt/ min 40/120min	40/120min
Peso Líquido-Bruto / Poids Net-Brut / Peso Neto-Bruto / Net-Gross Weight	kg 176-193	176-193
Potência / Puissance / Potência / Power	W 5300	5300
Tensão / Tension / Tension / Tension	V 400	400



bancada  
 plain de travail  
 encimera  
 worktop



móvel  
 mobile  
 móvil  
 mobile

**RT- R - BTM - BFM - BFX**



**Excelente esteticamente. Esquinas arredondadas que permitem maior segurança a trabalhar.**

Design extérieur particulièrement beau Angles arrondis pour une majeure sécurité au travail.  
Estéticamente excelente. Esquinas redondeadas que permiten mayor seguridad al trabajar.  
Beautiful exterior design rounded corners for better safety at work.



**Agitador com raspagem da lâmina em polietileno (PE) de longa duração. Todas as peças em contato com a mistura de creme ou gelo são de aço inoxidável e materiais atóxicos, de fácil acesso e removível para limpeza.**

Agitateur avec lame que gratte en polyéthylène (PE) à longue durée. Toutes les parties en contact avec le mélange ou la glace sont en acier inox et en matériau atoxique facilement accessibles et démontables pour le nettoyage.  
Agitator con lama raspante en polietileno (PE) de larga duración. Todas las partes en contacto con la mezcla o el helado son de acero inoxidable y de material atóxico fácilmente accesible y desmontable para la limpieza.  
Long-duration stirrer with rasp blade in polyethylene. All parts in contact with the mix or icecream are in stainless steel and in non-toxic material; all are easily accessible and removable for cleaning.



**Painel de Controlo com variação de velocidade, controle de densidade e botão reset que permite ao usuário, regular a velocidade de agitação e duração ideal do ciclo conforme o tipo de mistura.**

Panneau de commande avec variateur de vitesse, contrôle de densité et réarmement après défaut permet de choisir la vitesse de malaxage et la durée idéale du cycle par rapport au type de mélange.  
Tablero de control con cambiador de velocidad, control de densidad y botón de reset permite que el usuario regule la velocidad de la agitación y la duración ideal del ciclo en la conexión al tipo de mezcla.  
Control panel with variable speed, density control and reset allows the user to set the agitator speed and the ideal density of the batch in relation to the type of mix.



**Tampa dupla para adicionar ingredientes, enquanto o agitador está em movimento.**

Double couvercle pour insérer des ingrédients aussi quand l'agitateur est en mouvement.  
Doble tapa para aumentar ingredientes mientras el agitador está en movimiento.  
Double cover for adding ingredients while the mixer is working.

**Dispositivo micro magnético que para o agitador quando a tampa é aberta.**

Micro magnétique pour l'arrêt de l'agitateur avant l'ouverture du couvercle.  
Dispositivo micro magnético que detiene el agitador cuando se abre la tapa.  
Micromagnetic device for stopping the mixer before opening the cover.



**Suporte de bandeja ajustável, permitindo utilizar recipientes de medidas diferentes. (excepto modelos : BFX10, R5, RT5, BTM5, BTM10 e BFM10)**

Support de bassin réglable pour l'usage de conteneurs de différentes mesures.  
Soporte de calderines regulable que permite utilizar recipientes de diferentes medidas.  
Variable tray support for the use of containers of different sizes.



**A cuba de produção colocada verticalmente permite controlar a transformação da mistura em toda a fase.**

La cuve de production placée en position verticale permet de contrôler la transformation du mélange pendant toute la phase de travail.  
La tina de producción colocada en posición vertical permite controlar la transformación de la mezcla durante toda la fase.  
The vertically installed tank facilitates inspection of the mix during the working process.



**Extração automática. (excepto mod. R400)**

Extraction automatique.  
Extracción automática.  
Automatic extraction.

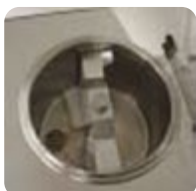

**Saída direta do gelado ou outro produto, pelo fundo da cuba de produção para uma extração mais rápida.**

Sortie directe de la glace ou d'un autre produit, par le fond de la cuve de production pour une extraction plus rapide.  
Direct output of ice cream or other product, through the bottom of the production vat for faster extraction.





udifri

## VITRINES EXPOSITORAS PARA GELATARIA

VITRINES POUR GLACERIE

VITRINAS PARA HELADERÍA

ICE-CREAM EXPOSERS



Sob pedido  
Sur demande  
Sobre pedido  
Upon request



**Covetes incluidas  
Cuvettes inclus  
Cubetas incluidas  
Cuvettes included  
4 X 2,5lt**



**Covetes incluidas  
Cuvettes inclus  
Cubetas incluidas  
Cuvettes included  
4 X 2,5lt**

MODELO / MODÈLE / MODELO / MODEL	V410C FS
CÓDIGO / CODE / CÓDIGO / CODE	2061.470
<b>Preço / Prix / Precio / Price</b>	<b>€ 2.226,00</b>
Dimensões / Dimensions / Dimensiones / Dimensions	mm 495x706x400
Temperatura / Température / Temperatura / Temperature	°C +4°/-25°C
Gás refrigerante / Gaz réfrigérant / Gas refrigerante / Refrig. gas	R507A
Covete / Cuvette / Cubeta / Cuvette	lt 4x2.5
Peso Líquido / Poids Net / Peso Neto / Net Weight	kg 34
Potência / Puissance / Potência / Power	W 180
Tensão / Tension / Tension / Tension	V 230

MODELO / MODÈLE / MODELO / MODEL	V410C FI
CÓDIGO / CODE / CÓDIGO / CODE	2061.464
<b>Preço / Prix / Precio / Price</b>	<b>€ 2.226,00</b>
Dimensões / Dimensions / Dimensiones / Dimensions	mm 495x495x620
Temperatura / Température / Temperatura / Temperature	°C +4°/-25°C
Gás refrigerante / Gaz réfrigérant / Gas refrigerante / Refrig. gas	R507A
Covete / Cuvette / Cubeta / Cuvette	lt 4x2.5
Peso Líquido / Poids Net / Peso Neto / Net Weight	kg 34
Potência / Puissance / Potência / Power	W 180
Tensão / Tension / Tension / Tension	V 230



**COVETE ADICIONAL  
2,5L C/ TAMP A P/ V410**

2061.476

**107,00**



2x2,5lt + 1x5lt

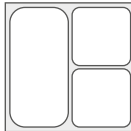

2x2,5lt

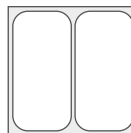

4x5lt

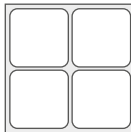

MODELO / MODÈLE / MODELO / MODEL	V410V FS
CÓDIGO / CODE / CÓDIGO / CODE	2061.460
<b>Preço / Prix / Precio / Price</b>	<b>€ 2.147,00</b>
Dimensões / Dimensions / Dimensiones / Dimensions	mm 495x706x439
Temperatura / Température / Temperatura / Temperature	°C +4°/-25°C
Gás refrigerante / Gaz réfrigérant / Gas refrigerante / Refrig. gas	R507A
Covete / Cuvette / Cubeta / Cuvette	lt 4x2.5 / 2x5 2x2.5+1x5
Peso Líquido / Poids Net / Peso Neto / Net Weight	kg 34
Potência / Puissance / Potência / Power	W 180
Tensão / Tension / Tension / Tension	V 230

MODELO / MODÈLE / MODELO / MODEL	V410V FI
CÓDIGO / CODE / CÓDIGO / CODE	2061.462
<b>Preço / Prix / Precio / Price</b>	<b>€ 2.147,00</b>
Dimensões / Dimensions / Dimensiones / Dimensions	mm 495x495x665
Temperatura / Température / Temperatura / Temperature	°C +4°/-25°C
Gás refrigerante / Gaz réfrigérant / Gas refrigerante / Refrig. gas	R507A
Covete / Cuvette / Cubeta / Cuvette	lt 4x2.5 / 2x5 2x2.5+1x5
Peso Líquido / Poids Net / Peso Neto / Net Weight	kg 34
Potência / Puissance / Potência / Power	W 180
Tensão / Tension / Tension / Tension	V 230



**COVETE  
180X165X120(H)2,5L  
2061.475**

**68,00**



**COVETE  
360X165X120(H)5L  
2050.050**

**46,00**



opcional  
opcionnel  
opcional  
optional



**5 Covetes policarbonato incluídas**  
 5 cuvettes polycarbonate inclus  
 5 cubetas policarbonato incluídas  
 5 polycarbonate cuvettes included



MODELO / MODÈLE / MODELO / MODEL	UDIFRI5VC	
CÓDIGO / CODE / CÓDIGO / CODE	2828.960	
<b>Preço / Prix / Precio / Price</b>	<b>€</b>	<b>1.223,00</b>
Dimensões / Dimensions / Dimensiones / Dimensions	mm	1010x 615x 949
Temperatura / Température / Temperatura / Temperature	°C	-12/-22
Refrigeração / Refrigeration / Refrigeracion / Cooling	S/V*	S
Covete / Cuvette / Cubeta / Cuvette (Exp)	nrxlt	5x4,8
Covete / Cuvette / Cubeta / Cuvette (Res)	nxlt	-
Peso Líquido-Bruto / Poids Net-Brut / Peso Neto-Bruto / Net-Gross Weight	kg	60-74
Potência / Puissance / Potência / Power	W	220
Tensão / Tension / Tension / Tension	V	230

**7 Covetes policarbonato incluídas**  
 7 cuvettes polycarbonate inclus  
 7 cubetas policarbonato incluídas  
 7 polycarbonate cuvettes included

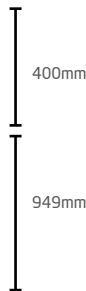

MODELO / MODÈLE / MODELO / MODEL	UDIFRI7VC	
CÓDIGO / CODE / CÓDIGO / CODE	2828.962	
<b>Preço / Prix / Precio / Price</b>	<b>€</b>	<b>1.340,00</b>
Dimensões / Dimensions / Dimensiones / Dimensions	mm	1300x 615x 949
Temperatura / Température / Temperatura / Temperature	°C	-12/-22
Refrigeração / Refrigeration / Refrigeracion / Cooling	S/V*	S
Covete / Cuvette / Cubeta / Cuvette (Exp)	nrxlt	7x4,8
Covete / Cuvette / Cubeta / Cuvette (Res)	nxlt	-
Peso Líquido-Bruto / Poids Net-Brut / Peso Neto-Bruto / Net-Gross Weight	kg	65-81
Potência / Puissance / Potência / Power	W	300
Tensão / Tension / Tension / Tension	V	230



**COVETE 5LT** 5 Lt ( 360X165X120)  
 2050.050 Fila dupla de reservas  
 Fila dupla empilhável  
**46,00**

**udi**fri**Covetes não incluídas  
Cuvettes non inclus  
Cubetas no incluídas  
Cuvettes not included****VITRINES EXPOSITORAS VENTILADAS PARA GELATARIA**VITRINES VENTILÉS POUR GLACERIE  
VITRINAS VENTILADAS PARA HELADERÍA  
ICE-CREAM VENTILATED EXPOSERSconfirmar disponibilidade dos produtos desta página  
confirmer la disponibilité des produits sur cette page  
confirmar la disponibilidad de los productos de esta página  
confirm the availability of the products on this page

MODELO / MODÈLE / MODELO / MODEL CÓDIGO / CODE / CÓDIGO / CODE		RUMBA 10 TUCANO
		2828.005
<b>Preço / Prix / Precio / Price</b>	<b>€</b>	<b>4.488,00</b>
Dimensões / Dimensions / Dimensiones / Dimensions	mm	1383x925x1280
Temperatura / Température / Temperatura / Temperature	°C	-10/-20
Covete / Cuvette / Cubeta / Cuvette (Exp)	lt	10x5
Peso Líquido-Bruto /Poids Net-Brut /Peso Neto-Bruto /Net-Gross Weight	kg	145-184
Potência / Puissance / Potência / Power	W	570
Tensão / Tension / Tension / Tension	V	230



MODELO / MODÈLE / MODELO / MODEL CÓDIGO / CODE / CÓDIGO / CODE		CARRELINO EIS
		2095.320
<b>Preço / Prix / Precio / Price</b>	<b>€</b>	<b>5.623,00</b>
Dimensões / Dimensions / Dimensiones / Dimensions	mm	1043x615x1213
Capacidade cuba / Cap cuve / Cap. cuba / Vat capacity	lt	4x5L
Peso Líquido-Bruto /Poids Net-Brut /Peso Neto-Bruto /Net-Gross Weight	kg	89-115
Potência / Puissance / Potência / Power	kW	0,350
Tensão / Tension / Tension / Tension	V	230



MODELO / MODÈLE / MODELO / MODEL CÓDIGO / CODE / CÓDIGO / CODE		VITTORIA 6 VIDROS PLANOS	VITTORIA 7 VIDROS PLANOS
		2727.002	2727.006
<b>Preço / Prix / Precio / Price</b>	<b>€</b>	<b>3.944,00</b>	<b>4.342,00</b>
Dimensões / Dimensions / Dimensiones / Dimensions	mm	1184x 800x 1176	1354x 800x 1176
Temperatura / Température / Temperatura / Temperature	°C	-16/-14	-16/-14
Refrigeração / Refrigeration / Refrigeracion / Cooling	S/V*	S	S
Covete / Cuvette / Cubeta / Cuvette (Exp)	nrxlt	6x5	7x5
Covete / Cuvette / Cubeta / Cuvette (Res)	nxlt	6x5	7x5
Peso Líquido-Bruto /Poids Net-Brut /Peso Neto-Bruto /Net-Gross Weight	kg	97-113	102-130
Potência / Puissance / Potência / Power	W	590	680
Tensão / Tension / Tension / Tension	V	230	230

12 (+12)

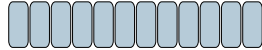

MODELO / MODÈLE / MODELO / MODEL CÓDIGO / CODE / CÓDIGO / CODE		SAONA 12 VIDROS CURVOS
		2727.018
<b>Preço / Prix / Precio / Price</b>	<b>€</b>	<b>8.063,00</b>
Dimensões / Dimensions / Dimensiones / Dimensions	mm	2119x630x1247
Temperatura / Température / Temperatura / Temperature	°C	-16/-14
Covete / Cuvette / Cubeta / Cuvette (Exp)	lt	12x5
Covete / Cuvette / Cubeta / Cuvette (Res)	lt	12x5
Peso Líquido-Bruto /Poids Net-Brut /Peso Neto-Bruto /Net-Gross Weight	kg	172
Potência / Puissance / Potência / Power	W	1800
Tensão / Tension / Tension / Tension	V	230

Disposição Covetes  
Disposition cuvettes  
Disposición cubetas  
Cuvettes arrangement

6(+6)



7(+7)

**COVETE 5LT**  
**2050.050****46,00**5 Lt ( 360X165X120)  
Fila dupla de reservas  
Fila dupla empilhável**LAVA PORCIONADOR  
P/ VITTORIA/SAONA****2727.190****254,00**

**Porta opaca**

 Porte opaque  
 Puerta opaca  
 Opaque door

**Inclui 10 pares de guias (grelha 800x600mm)**

 Comprend 10 paires de guides (grilles 800x600mm)  
 Incluye 10 pares de guias (rejillas 800x600mm)  
 Includes 10 pairs of guides (grills 800x600mm)

Containers não incluídos  
 Containers non inclu  
 Containers non include  
 Containers not included

MODELO / MODÈLE / MODELO / MODEL	ARGE 800 BT GELATARIA	
CÓDIGO / CODE / CÓDIGO / CODE	2929.136	
<b>Preço / Prix / Precio / Price</b>	<b>€</b>	<b>3.490,00</b>
Dimensões / Dimensions / Dimensiones / Dimensions	mm	740x990x2010
Volume / Volume / Volume / Volume	lt	737
Temperatura / Température / Temperatura / Temperature	°C	-18/-23
Gás refrigerante / Gaz réfrigérant / Gas refrigerante / Refrig. Gas		R404A
Peso Líquido-Bruto / Poids Net-Brut / Peso Neto-Bruto / Net-Gross Weight	kg	156-168
Potência / Puissance / Potencia / Power	kW	0,5
Tensão / Tension / Tensión / Tension	V	230

Descongelación / Décongélation / Descongelación / Defrosting





udifri

**MÁQUINAS DE CHANTILLY**  
MACHINES À CHANTILLY  
MAQUINAS CREMA BATIDA  
CHANTILLY MACHINES



confirmar disponibilidade dos produtos desta página  
confirmer la disponibilité des produits sur cette page  
confirmar la disponibilidad de los productos de esta página  
confirm the availability of the products on this page



MODELO / MODÈLE / MODELO / MODEL	PROWIP 5 240L	
CÓDIGO / CODE / CÓDIGO / CODE	2061.110	
<b>Preço / Prix / Precio / Price</b>	<b>€</b>	<b>6.942,00</b>
Dimensões / Dimensions / Dimensiones / Dimensions	mm	310x630x510
Capacidade cuba / Cap cuve / Cap. cuba / Vat capacity	lt	6
Produção / Production / Producción / Production	lt/h	240
Peso Líquido-Bruto / Poids Net-Brut / Peso Neto-Bruto / Net-Gross Weight	kg	-/53
Potência / Puissance / Potência / Power	kW	0,18
Tensão / Tension / Tension / Tension	V	230



MODELO / MODÈLE / MODELO / MODEL	PROLAB 10 250L	
CÓDIGO / CODE / CÓDIGO / CODE	2061.115	
<b>Preço / Prix / Precio / Price</b>	<b>€</b>	<b>4.710,00</b>
Dimensões / Dimensions / Dimensiones / Dimensions	mm	300x475x470
Capacidade cuba / Cap cuve / Cap. cuba / Vat capacity	lt	10
Produção / Production / Producción / Production	lt/h	250
Peso Líquido-Bruto / Poids Net-Brut / Peso Neto-Bruto / Net-Gross Weight	kg	-/42
Potência / Puissance / Potência / Power	kW	0,5
Tensão / Tension / Tension / Tension	V	230



**PREVENÇÃO E SAÚDE**  
PRÉVENTION ET SANTÉ  
PREVENCION Y SALUD  
PREVENTION AND HEALTH





Dispensador automático de gel, a pilhas.  
 Estável e seguro.  
 Funciona com todo tipo de gel desinfetante.  
 Três opções de dosagem.  
 Utiliza 6 pilhas AA LR6 de 1.5V (não incluídas).  
 Higiénico, com bandeja para contenção de resíduos.  
 Permite personalização para que possa promover as suas marcas (a partir de 50 unidades).  
 Suporte em chapa lacada a branco de 1,5mm.



Distributeur de gel automatique, à piles.  
 Stable et sécurisé.  
 Fonctionne avec tous les types de gel désinfectant.  
 Trois options de dosage.  
 Utilise 6 piles AA LR6 1,5 V (non incluses).  
 Hygiénique, avec bac de rétention des déchets.  
 Il permet la personnalisation afin que vous puissiez promouvoir vos marques (à partir de 50 unités).  
 Support en plaque laquée blanche de 1,5 mm.



Dispensador de gel automático, funciona con pilas.  
 Estable y seguro.  
 Funciona con todo tipo de gel desinfectante.  
 Tres opciones de dosificación.  
 Utiliza 6 pilas AA LR6 de 1,5 V (no incluidas).  
 Higiénico, con bandeja de contención de residuos.  
 Permite la personalización para que puedas promocionar tus marcas (a partir de 50 unidades).  
 Soporte en placa de 1,5 mm lacada en blanco.



Automatic gel dispenser, battery operated.  
 Stable and secure.  
 Works with all types of disinfectant gel.  
 Three dosage options.  
 Uses 6 1.5V AA LR6 batteries (not included).  
 Hygienic, with tray to contain waste.  
 It allows customization so you can promote your brands (from 50 units).  
 Support in 1.5mm white lacquered plate.



UDI

ESTAÇÃO DE DESINFECÇÃO  
STATION DE DÉSINFECTIION  
ESTACIÓN DE DESINFECCIÓN  
DESINFECTIION STATION



sob pedido  
sur demande  
a pedido  
on request

MODELO / MODÈLE / MODELO / MODEL

COLUNA  
DESINFECÇÃO  
DOSEADOR AUTO  
2236.820

CÓDIGO / CODE / CÓDIGO / CODE

Preço / Prix / Precio / Price

€ 324,00

Dimensões do Suporte (mm) / Dimensions du support (mm) / Dimensiones de soporte / Base Dimensions

mm 300x300x1465

Dimensões do doseador (mm) / Dimensions du distributeur (mm) / Dimensiones del dispensador / Dimensions of the dispenser

lt 135x130x272

Capacidade do doseador (ml) / Capacité de dosage (ml) / Capacidad de dosificación / Dosing capacity

ml 1000



Armário de farmácia com porta de vidro, termostato eletrónico, alarme sonoro, prateleiras ajustáveis, sistema de descongelção automático, porta reversível. Luz interior LED. Acabamento interior em ABS branco. Com fechadura e chave.



Armoire de pharmacie avec porte vitrée à charnières, thermostat électronique, signal d'alarm audible, dégivrage automatique, porte réversible. Éclairage intérieur LED. Finition intérieure en ABS blanc. Avec serrure et clé montées de série.



Nevera médica con puerta batiente de cristal, termostato electrónico, alarma acústica, descongelación automática, puerta reversible. Luz interior LED. Acabado interior en ABS blanco. Con cierre y llave de serie.



Medical cooler with hinged glass door, electronic thermostat, audible alarm signal, automatic defrost, reversible door. Inside light LED. Interior finish in white ABS. With lock and key.



+ INFO



MODELO / MODÈLE / MODELO / MODEL	UDIFARMA300-L PV	
CÓDIGO / CODE / CÓDIGO / CODE	2828.480	
<b>Preço / Prix / Precio / Price</b>	<b>€</b>	<b>1.186,00</b>
Dimensões Ext. / Dimensions Ext. / Dimensiones Ext. / Dimensions Ext.	mm	595x640x1635
Dimensões Int. / Dimensions Int. / Dimensiones Int. / Dimensions Int.	mm	470x440x1347
Nível Ruído / Niveau de bruit / Nivel de ruido / Noise level	dB(A)	45
Consumo / Consommation / Consumo / Consumption	kWh/24h	2
Temperaturas / Temperatures / Temperaturas / Temperatures	°C	+2~/+10
Capacidade / Capacité / Capacidad / Capacity	Lt	290
Peso Líquido-Bruto / Poids Net-Brut / Peso Neto-Bruto / Net-Gross Weight	kg	70-79,3
Gás / Gaz / Gas / Gas		R600a
Potência / Puissance / Potencia / Power	W	266
Tensão / Tension / Tensión / Tension	V	230



MODELO / MODÈLE / MODELO / MODEL	UDIFARMA400-L PV	
CÓDIGO / CODE / CÓDIGO / CODE	2828.482	
<b>Preço / Prix / Precio / Price</b>	<b>€</b>	<b>1.384,00</b>
Dimensões Ext. / Dimensions Ext. / Dimensiones Ext. / Dimensions Ext.	mm	595x640x1840
Dimensões Int. / Dimensions Int. / Dimensiones Int. / Dimensions Int.	mm	470x440x1555
Nível Ruído / Niveau de bruit / Nivel de ruido / Noise level	dB(A)	45
Consumo / Consommation / Consumo / Consumption	kWh/24h	2,3
Temperaturas / Temperatures / Temperaturas / Temperatures	°C	+2~/+10
Capacidade / Capacité / Capacidad / Capacity	Lt	347
Peso Líquido-Bruto / Poids Net-Brut / Peso Neto-Bruto / Net-Gross Weight	kg	75,5-84,9
Gás / Gaz / Gas / Gas		R600a
Potência / Puissance / Potencia / Power	W	295
Tensão / Tension / Tensión / Tension	V	230



UDI **farma+**

**ARMÁRIOS FARMÁCIA**  
ARMOIRES PHARMACY  
ARMARIOS FARMACIA  
PHARMACY COOLERS



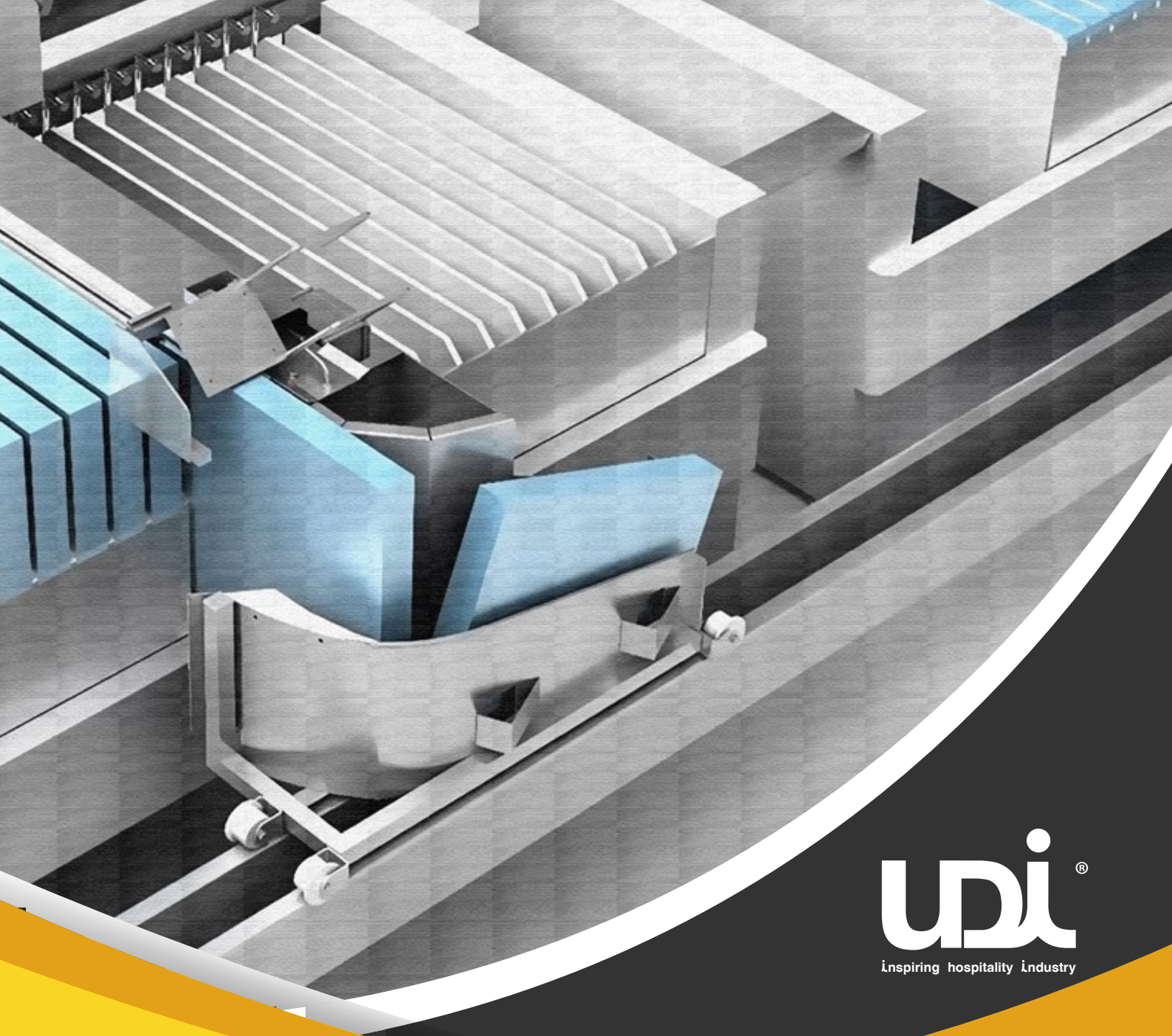

**UDI**<sup>®</sup>  
Inspiring hospitality Industry

# **SOLUÇÕES** **PROJETOS INDUSTRIAIS**

*Industrial Project Solutions*



## UDi, acrescenta valor ao seu negócio *UDi, adds value to your business*

Inovação | Qualidade | Marcas de Prestígio | Equipa Qualificada | Formação Contínua de Ativos  
*Innovation | Quality | Prestigious Brands | Qualified Team | Continuous Training of Assets*



Garantimos a melhor solução para o seu negócio através de uma proposta de valor que engloba: estudo das necessidades do projecto; fornecimento de equipamentos altamente eficientes e eficazes que potenciarão o retorno do seu investimento; acompanhamento da implementação.

*We guarantee the best solution for your business through a value proposition which includes: study of the needs of the project; providing highly efficient and effective equipment that boosts the payback of your investment; monitoring of the implementation.*

# Agroindústria

## Agroindústria

A nossa proposta de valor consiste num portefólio de soluções e produtos inovadores de maior valor acrescentado económico e alimentar.

*Our value proposition consists of a portfolio of innovative solutions and products with greater economic and food value added.*

Pesca e Indústria do Pescado | *Fishing and Fishing Industry*

Indústria das Aves | *Poultry Industry*

Indústria das Frutas | *Fruit Industry*

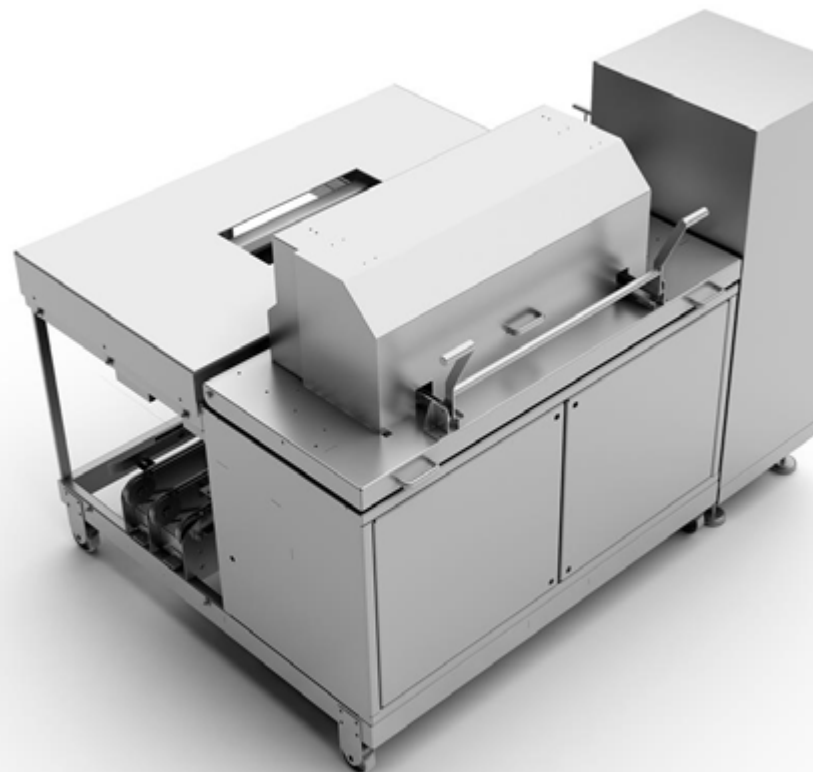

# Indústria da Panificação e Pastelaria

## *Bakery and Pastry Industry*

As exigências da produção em grandes quantidades desencadeou o desenvolvimento de soluções tecnológicas para todos os processos desta indústria em expansão.

*The demands of production in massive quantities triggered the development of technological solutions for all processes of this expanding industry.*



# Consultoria de Projetos Industriais

## *Industrial Projects Consulting*

Restauração Coletiva  
*Dining Hall*

Equipamentos para Retalho Alimentar  
*Food Retail Equipment*

Cozinha Industrial  
*Industrial Kitchen*

Frio Industrial  
*Industrial Cold*

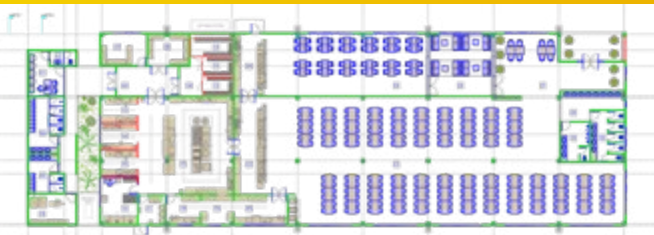

# Saúde Health

Integrado nos serviços, o sector da Saúde encontra-se em grande expansão por todo o mundo, quer ao nível da área Hospitalar quer da área farmacêutica. Sendo um sector altamente regulamentado todos os investimentos exigem elevados padrões de performance nas soluções a implementar. Apresentamos equipamentos que satisfazem todos os requisitos legais e funcionais.

*Integrated in the services, the Health sector is in great expansion all over the world, as much in the Hospital area as in the pharmaceutical area. Being a highly regulated sector, all investments require high standards of performance in the solutions to be implemented. We present equipment that meets all legal and functional requirements.*

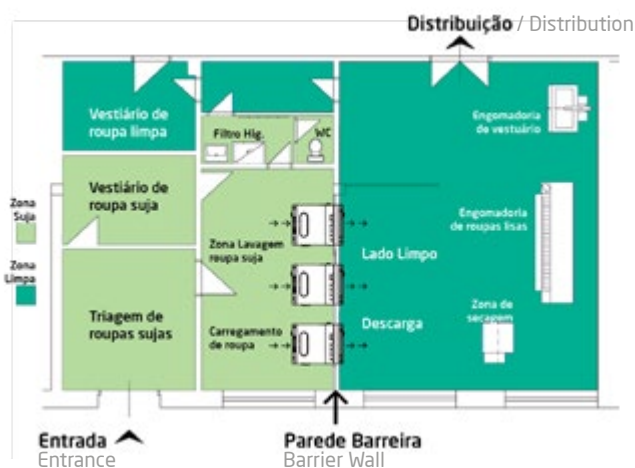

Não existindo acordo escrito da nossa parte, as presentes condições gerais de venda prevalecem sobre todas as disposições contrárias. A UDEX S.A não vende diretamente ao público.

## 1. PREÇOS

1.1. - Os preços constantes das nossas propostas e tabelas poderão sofrer eventuais ajustamentos sempre que se verificarem alterações imprevisíveis e por nós incontornáveis nos, preços de origem, nos fretes e seguros, na paridade das moedas ou quaisquer outras variáveis que provoquem alterações nos preços.

1.2. - Os nossos preços são sempre sem impostos e consideram-se à saída dos nossos armazéns ou entrepostos. Aos preços deduzidos de todos os descontos acrescem todos os impostos em vigor à data da faturação (IVA), os quais são por conta do comprador.

1.3. - As mercadorias serão faturadas pelo preço em vigor na data da encomenda.

1.4. - Os nossos preços de venda poderão ser alterados por meio de simples aviso ao comprador. Os novos preços serão aplicados a todas as encomendas pendentes de entrega à data da alteração. Se o comprador não aceitar o novo preço, poderá anular a encomenda com notificação por escrito dentro dos 8 dias seguintes à data do aviso. Passado este prazo, entender-se-á que aceita plenamente as novas condições.

## 2. TABELAS, CATALOGOS, PROPOSTAS E ENCOMENDAS

2.1. - A informação, que a título de orientação e verbalmente fornecemos, tanto no respeitante a preços, modelos, dimensões, imagens e características, como especificações e orçamentos, é livre de qualquer compromisso e não nos obriga a mantê-la e pode ser modificada sem aviso prévio.

2.2. - As propostas são sempre e para todos os efeitos, condicionadas à nossa posterior aceitação, por escrito, da respetiva encomenda.

2.3. - As encomendas devem ser efetuadas por escrito, sob pena de serem inválidas.

2.4. - As encomendas serão faturadas pelo preço em vigor na data da encomenda, sempre que a encomenda seja colocada dentro do prazo de validade de 8 dias. Caso tal não aconteça, será enviado novo orçamento.

2.5. - As encomendas aceitam-se na condição bem expressa de que nos reservamos o direito de modificar os modelos, imagens, dados técnicos, preços, aumentos e descontos, mediante aviso prévio ao comprador. As encomendas que se encontrem pendentes à data de uma eventual alteração das condições de venda, serão executadas já sob as novas condições, ficando assente que nessas circunstâncias assiste aos clientes o direito de anular essas encomendas por escrito dentro dos 8 dias seguintes à data do aviso prévio.

2.6. - Qualquer condição pedida pelo comprador que não se ajuste às nossas condições gerais de venda é considerada nula, salvo nossa aceitação por escrito.

2.7. - As encomendas não podem ser anuladas quando:

- Tenham passado 3 dias desde a data da encomenda.

- Se tratar de produtos de fabrico especial, e o mesmo já tenha iniciado.

- Se tenha efetuado expedição da mercadoria

2.8. - Reservamo-nos o direito de anular as encomendas pendentes de entrega quando o comprador não tenha cumprido total ou parcialmente contratos anteriores.

2.9. - Os preços e condições patentes nos catálogos, são válidos durante o período da sua vigência, salvo erros de impressão ou tipográficos.

## 3. ENTREGA

3.1. - Os prazos de fornecimento que se indiquem verbalmente sempre se entenderão sem compromisso, pelo que devem ser reduzidos a escrito.

3.2. - As circunstâncias que caiam fora do âmbito de controlo da Udex, ou dos nossos fornecedores, nomeadamente acidentes de fabrico, greves, condicionalismos governamentais, e em resumo todas as causas de força maior, e dificultem, ou tornem impossível o fornecimento, libertam a Udex das suas obrigações contratuais durante a duração das causas de força maior e na amplitude das suas consequências, permitindo a suspensão ou cancelamento das encomendas dos clientes, sem qualquer responsabilização pelas consequências diretas ou indiretas que daí possam resultar.

Nas situações relevantes, o comprador será informado, logo que possível, sobre a data de início e fim dos impedimentos.

3.3. - A transferência do risco ocorre no momento da entrega da mercadoria à transportadora ou transitário ou, no máximo, no momento da saída da mercadoria da fábrica ou do armazém. Todas as mercadorias viajam, sem exceção, por conta e risco do comprador, seja qual for a via utilizada. Salvo acordo em contrário, ou que assim se indique nas condições especiais de cada produto, não assumimos os riscos do transporte, que serão totalmente a cargo do comprador, inclusive quando os danos e deteriorações durante o transporte sejam devidos a caso fortuito ou de força maior. O facto da UDEX S.A contratar o transporte das mercadorias e de que, em alguns casos, seja concedido um bônus ao seu preço, não pressupõe a anulação da cláusula anterior nem a aceitação por nossa parte dos riscos do mesmo.

3.4. - As mercadorias são expedidas embaladas com embalagem habitual, ou de acordo com o nosso catálogo. Para embalagens a pedido do comprador serão debitados os preços correspondentes.

3.5. - Não aceitamos a devolução das nossas embalagens por serem do tipo irrecuperável.

## 4. PAGAMENTO

4.1. - O pagamento do preço das nossas mercadorias deve ser feito em dinheiro nos nossos escritórios da Maia, salvo se for concedido crédito ao comprador. Nesse caso efetuar-se-á no prazo ou prazos expressamente estipulados.

4.2. - Os pagamentos devem ser efetuados nas condições estipuladas pela UDEX S.A, ou na falta de indicação nos termos definidos pelo Decreto-lei n.º 62/2013, de 10/05, verificando-se em caso de mora o estabelecido naquele diploma legal. Se o comprador não liquidar as suas faturas nos prazos de vencimento estabelecidos, fica sujeito ao pagamento de juros de mora e do correspondente ágio, se a moeda tiver sofrido depreciação.

4.3. - Se antes da execução da totalidade ou parte de um pedido ocorresse ou se tornassem conhecidos factos ou circunstâncias que causem um fundamentado receio de que o comprador não cumprirá a sua obrigação de pagamento do preço, poder-se-á suspender a entrega das mercadorias se o comprador não antecipar o seu pagamento e/ou garanti-lo no prazo acordado.

4.4. - As mercadorias faturadas são de nossa propriedade até integral pagamento.

## 5. RECLAMAÇÕES E DEVOLUÇÕES

5.1. - Sempre que as entregas das mercadorias sejam efetuadas pelo nosso transporte, as reclamações deverão ser feitas na presença do nosso motorista e devidamente assinaladas nas faturas, ou documentos que acompanhe a mercadoria no transporte. No caso de impossibilidade de se verificar a encomenda aquando da sua receção, a reclamação do produto pode ser feita no prazo de 8 dias a contar da entrega do produto.

5.2. - Não são da nossa responsabilidade despa-

chos de mercadorias, nem anomalias causadas pelos transportadores. A devolução ou troca de material apenas será aceite, até 8 dias da data da entrega da mercadoria e o mesmo terá de se apresentar novo, devidamente embalado na caixa de origem e sem falta de peças. Não aceitaremos qualquer reclamação posterior.

5.3. - Não se aceitam devoluções, salvo as que forem autorizadas expressamente pela Udex, por escrito. Os gastos e custos de transportes e embalagens são por conta do comprador. O material tem de estar conforme o ponto 5.2.

5.4. - Em caso de devolução, do preço pago pelo cliente será descontada a percentagem de 10 % referente a despesas de receção e ensaios.

## 6. GARANTIA

6.1. - Os nossos produtos, sempre e quando sejam utilizados em condições normais e instalados de acordo com as normas em vigor, estão garantidos contra todos os defeitos de fabrico durante o prazo de 12 meses da data de saída do nosso armazém. Para usufruir desta garantia será necessário, em cada caso, a aceitação do defeito pelo nosso Departamento Técnico, devendo ser enviados os produtos defeituosos ao nosso armazém. A nossa garantia cobre unicamente substituição de acessórios. Não inclui reposição de gás, frêon, filtros, mão-de-obra, soldas e deslocações. Em caso algum poderemos ser responsabilizados pelos danos e prejuízos que pelo seu defeito se verifique, direta ou indiretamente. Só abrange defeitos de fabrico. Nunca defeitos de funcionamento originados por deficiências nos fornecimentos de água, eletricidade ou de instalação independentes dos primeiros. Os gastos, portes, embalagens, etc. que se originem nas reparações ao abrigo da garantia são por conta do cliente.

6.2. - Não está incluído na garantia:

- Lâmpadas, diodos, válvulas, transístores, vidros, plásticos e demais partes quebráveis, partes elétricas, partes eletrónicas, resistências, motores, etc.

Situações em que a garantia não pode ser exigida:

1 - Sempre que o aparelho não seja utilizado de acordo com o modo de emprego.

2 - Se a chapa de Identificação for arrancada ou modificada.

3 - Se o aparelho for modificado.

4 - Quando o seu funcionamento deficiente se deva a maus-tratos, causas externas (valores incorretos de tensão, descargas atmosféricas), exposições às intempéries etc.

5 - Se o aparelho nos for entregue sem componentes.

6 - Falta de cumprimento do contratado (por parte do comprador).

7 - Quando não seja respeitado o acima referido no ponto 5.2 das nossas condições gerais de venda.

## 7. PROPRIEDADE DA MERCADORIA

7.1. - No caso de pagamento do preço em prestações ou feito acordo para pagamento em data posterior à da efectiva entrega dos bens, a UDEX, S.A. reserva para si o direito de propriedade desses mesmos bens até que se encontre integralmente pago o respectivo preço. No caso de não pagamento do preço na(s) data(s) do vencimento, e após resolução do contrato, a UDEX, S.A. reserva-se o direito de proceder à recolha dos bens transacionados, sem necessidade de ulterior interpeleção.

7.2. - Para todas as questões emergentes do contrato, as partes reconhecem como competentes os Tribunais Portugueses, com expressa renúncia a qualquer outro foro.

8. Nenhum empregado, agente, vendedor ou representante da empresa está autorizado a alterar ou anular quaisquer das condições aqui indicadas que só podem ser modificadas mediante acordo da nossa empresa, confirmado por escrito.



# CONDITIONS GENERALES DE VENTE



A défaut d'accord écrit de notre part, ces conditions générales de vente prévaudront sur toutes dispositions contraires. UDEX S.A ne vend pas directement au public.

## 1. PRIX

1.1. - Les prix contenus dans nos propositions et tableaux peuvent faire l'objet d'éventuels ajustements en cas de modifications imprévisibles et incontrôlables des prix d'origine, du fret et de l'assurance, de la parité monétaire ou de toute autre variable entraînant des modifications des prix.

1.2. - Nos prix sont toujours hors taxes et s'entendent au départ de nos entrepôts ou entrepôts. Toutes les taxes en vigueur au moment de la facturation (TVA) s'ajoutent aux prix déduits de toutes remises, qui sont à la charge de l'acheteur.

1.3. - Les marchandises seront facturées au prix en vigueur à la date de la commande.

1.4. - Nos prix de vente peuvent être modifiés sur simple notification à l'acheteur. Les nouveaux prix s'appliqueront à toutes les commandes en attente de livraison à la date du changement. Si l'acheteur n'accepte pas le nouveau prix, il peut annuler la commande par notification écrite dans les 8 jours suivant la date de notification. Passé ce délai, il sera entendu que vous acceptez pleinement les nouvelles conditions.

## 2. TABLEAUX DE PRIX, CATALOGUES, PROPOSITIONS ET COMMANDES

2.1. - Les informations que nous fournissons verbalement et à titre indicatif, tant en ce qui concerne les prix, les modèles, les dimensions, les images et les caractéristiques, que les spécifications et les budgets, sont libres de tout engagement et ne nous obligent pas à les conserver et peuvent être modifiés sans préavis.

2.2. - Les propositions sont toujours et à toutes fins conditionnées à notre acceptation ultérieure, par écrit, de la commande correspondante.

2.3. - Les commandes doivent être passées par écrit, faute de quoi elles ne seront pas considérées comme valables.

2.4. - Les commandes seront facturées au prix en vigueur au jour de la commande, dès lors que la commande est passée dans le délai de validité de 8 jours. Dans le cas contraire, un nouveau devis sera envoyé.

2.5. - Les commandes sont acceptées à la condition expresse que nous nous réservons le droit de modifier les modèles, les images, les données techniques, les prix, les augmentations et les remises, après notification préalable à l'acheteur. Les commandes en cours à la date d'une éventuelle modification des conditions de vente seront exécutées aux nouvelles conditions, étant entendu que dans ces circonstances les clients ont le droit d'annuler ces commandes par écrit dans les 8 jours suivant la date de notification préalable.

2.6. - Toute condition demandée par l'acheteur non conforme à nos conditions générales de vente est considérée comme nulle et non avenue, sauf si nous l'acceptons par écrit.

2.7. - Les commandes ne peuvent pas être annulées lorsque :

- 3 jours se sont écoulés depuis la date de commande.

- Dans le cas de produits de fabrication spéciale, et le même a déjà commencé.

- Si vous avez expédié la marchandise

2.8. - Nous nous réservons le droit d'annuler les commandes en attente de livraison lorsque l'acheteur n'a pas entièrement ou partiellement rempli les contrats précédents.

2.9. - Les prix et conditions figurant dans les catalogues sont valables pendant la période de validité, sauf erreur d'impression ou typographique.

## 3. LIVRAISON

3.1. - Les délais de livraison indiqués verbalement seront toujours entendus sans engagement, ils doivent donc être consignés par écrit.

3.2. - Les circonstances indépendantes de la volonté d'Udex ou de nos fournisseurs, à savoir les accidents de fabrication, les grèves, les contraintes gouvernementales, et en bref toutes les causes de force majeure, et rendant difficile ou impossible l'approvisionnement, libèrent Udex de ses obligations contractuelles pendant la durée des causes de force majeure et l'étendue de ses conséquences, permettant la suspension ou l'annulation des commandes des clients, sans aucune responsabilité pour les conséquences directes ou indirectes pouvant en découler.

Dans les situations pertinentes, l'acheteur sera informé, dans les meilleurs délais, de la date de début et de fin des empêchements.

3.3. - Le transfert des risques s'effectue au moment de la remise des marchandises au transporteur ou au transitaire ou, au maximum, au moment où les marchandises quittent l'usine ou l'entrepôt. Toutes les marchandises voyagent, sans exception, aux risques et frais de l'acheteur, quel que soit le trajet emprunté. Sauf convention contraire, ou indication contraire dans les conditions particulières de chaque produit, nous n'assurons pas les risques de transport, qui seront entièrement à la charge de l'acheteur, même lorsque les dommages et détériorations pendant le transport sont dus à un cas fortuit ou à un cas de force majeure. Le fait que UDEX S.A contracte le transport des marchandises et que, dans certains cas, une prime soit accordée à leur prix, n'implique pas l'annulation de la clause précédente ni l'acceptation de notre part des risques de celle-ci.

3.4. - Les marchandises sont expédiées emballées dans les emballages habituels ou conformes à notre catalogue. Pour les forfaits à la demande de l'acheteur, les prix correspondants seront facturés.

3.5. - Nous n'acceptons pas le retour de nos colis car ils ne sont pas retournables.

## 4. PAIEMENT

4.1. - Le paiement du prix de nos marchandises doit être effectué au comptant à nos bureaux de Maia, sauf si un crédit est accordé à l'acheteur. Dans ce cas, elle sera exécutée dans le délai ou les délais expressément stipulés.

4.2. - Les paiements doivent être effectués dans les conditions prévues par UDEX S.A, ou à défaut d'indication dans les conditions définies par le décret-loi n° cool. Si l'acheteur ne règle pas ses factures dans les délais fixés, il est passible du paiement d'intérêts de retard et de la prime correspondante, si la devise s'est dépréciée.

4.3. - Si, avant l'exécution de tout ou partie d'une commande, des faits ou circonstances surgissent ou deviennent connus qui font craindre avec raison que l'acheteur ne remplira pas son obligation de payer le prix, la livraison des marchandises pourra être suspendu si l'acheteur n'anticipe pas le paiement et/ou ne le garantit pas dans le délai convenu.

4.4. - Les marchandises facturées sont notre propriété jusqu'au paiement intégral.

## 5. RECLAMATIONS ET RETOURS

5.1. - Chaque fois que les marchandises sont livrées par nos moyens de transport, les réclamations doivent être faites en présence de notre chauffeur et dûment indiquées sur les factures ou les documents accompagnant les marchandises pendant le transport. S'il n'est pas possible de vérifier la commande à réception, une réclamation pour le produit peut être faite dans les 8 jours à compter de la livraison du produit.

5.2. - Nous ne sommes pas responsables de l'expédition des marchandises, ni des anomalies causées par les transporteurs. Le retour ou l'échange de matériel ne sera accepté que jusqu'à 8

jours à compter de la date de livraison de la marchandise et il doit être neuf, correctement emballé dans la boîte d'origine et sans pièces manquantes. Nous n'accepterons aucune autre réclamation.

5.3. - Les retours ne sont pas acceptés, sauf autorisation expresse écrite d'Udex. Les frais et dépenses de transport et d'emballage sont à la charge de l'acheteur. Le matériel doit être conforme au point 5.2.

5.4. - En cas de retour, le prix payé par le client sera déduit d'un pourcentage de 10% se référant aux frais de réception et d'essai.

## 6. GARANTIE

6.1. - Nos produits, pour autant qu'ils soient utilisés dans des conditions normales et installés conformément à la réglementation en vigueur, sont garantis contre tout vice de fabrication pendant une durée de 12 mois à compter de leur sortie de nos entrepôts. Afin de bénéficier de cette garantie, il sera nécessaire, dans chaque cas, d'accepter le défaut par notre service technique, et les produits défectueux doivent être envoyés à notre entrepôt. Notre garantie ne couvre que le remplacement des accessoires. Ne comprend pas le remplacement du gaz, du fréon, des filtres, de la main-d'œuvre, de la soudure et des déplacements. En aucun cas nous ne pourrions être tenus responsables des dommages causés par votre défaut, directement ou indirectement. Elle ne couvre que les défauts de fabrication. Jamais de dysfonctionnements causés par des manques d'eau, d'électricité ou d'installations indépendantes des premières. Frais, expédition, emballage, etc. résultant de réparations sous garantie sont à la charge du client.

6.2. - Non inclus dans la garantie :

- Lampes, diodes, valves, transistors, verre, plastiques et autres pièces cassables, pièces électriques, pièces électroniques, résistances, moteurs, etc.

Situations dans lesquelles la garantie ne peut être exigée :

1 - Chaque fois que l'appareil n'est pas utilisé conformément au mode d'utilisation.

2 - Si la plaque signalétique est arrachée ou modifiée.

3 - Si l'appareil est modifié.

4 - Lorsque son dysfonctionnement est dû à un abus, à des causes extérieures (valeurs de tension erronées, décharges atmosphériques), à une exposition aux intempéries, etc.

5 - Si l'appareil nous est livré sans composants.

6 - Non-respect du contrat (par l'acheteur).

7 - Lorsque ce qui précède mentionné au point 5.2 de nos conditions générales de vente n'est pas respecté.

## 7. PROPRIÉTÉ DES MARCHANDISES

7.1. - En cas de paiement échelonné du prix ou d'accord de paiement à une date postérieure à la livraison effective de la marchandise, UDEX, S.A. se réserve le droit de propriété sur ces mêmes marchandises jusqu'au paiement intégral du prix correspondant. En cas de non-paiement du prix à la ou aux échéances, et après la résiliation du contrat, UDEX, S.A. se réserve le droit de procéder à la collecte des marchandises échangées, sans qu'il soit besoin d'une nouvelle interpellation.

7.2. - Pour toutes les questions découlant du contrat, les parties reconnaissent les tribunaux portugais comme compétents, avec renonciation expresse à toute autre juridiction.

8. Aucun employé, agent, vendeur ou représentant de la société n'est autorisé à modifier ou annuler l'une quelconque des conditions indiquées dans les présentes qui ne peuvent être modifiées qu'avec l'accord de notre société, confirmé par écrit.



embalagens especiais e/ou madeira sob consulta  
emballage spécial et/ou de bois sur demande  
embalajes especiales y/o de madera bajo consulta  
special packaging and/or wood on request

En ausencia de un acuerdo escrito por nuestra parte, estas condiciones generales de venta prevalecen sobre todas las disposiciones contrarias. UDEX S.A no vende directamente al público.

## 1. PRECIOS

1.1. - Los precios contenidos en nuestras propuestas y tarifas pueden estar sujetos a posibles ajustes siempre que existan cambios imprevisibles e incontrolables en los precios de origen, fletes y seguros, paridad de moneda o cualquier otra variable que provoque cambios en los precios.

1.2. - Nuestros precios son siempre libres de impuestos y son considerados al salir de nuestros depósitos o almacenes. A los precios descontados de todos los descuentos se le suman todos los impuestos vigentes en el momento de la facturación (IVA), que corren a cargo del comprador.

1.3. - La mercancía se facturará al precio vigente en la fecha del pedido.

1.4. - Nuestros precios de venta pueden ser modificados simplemente comunicándolo al comprador. Los nuevos precios se aplicarán a todos los pedidos pendientes de entrega en la fecha del cambio. Si el comprador no acepta el nuevo precio, podrá cancelar el pedido con notificación por escrito dentro de los 8 días siguientes a la fecha de la notificación. Transcurrido dicho plazo, se entenderá que acepta plenamente las nuevas condiciones.

## 2. TARIFAS, CATALOGOS, PROPUESTAS Y PEDIDOS

2.1. - La información que proporcionamos a título de orientación y verbalmente, ya sea en lo que respecta a precios, modelos, dimensiones, imágenes y características, así como especificaciones y presupuestos, no está sujeta a ningún compromiso y no nos obliga a mantenerla, pudiendo ser modificada sin previo aviso.

2.2. - Las propuestas quedan siempre y a todos los efectos, condicionadas a nuestra posterior aceptación, por escrito, del correspondiente pedido.

2.3. - Los pedidos deben realizarse por escrito, de lo contrario no se considerarán válidos.

2.4. - Los pedidos se facturarán al precio vigente en la fecha del pedido, siempre que el pedido se realice dentro del plazo de validez de 8 días. De no ser así, se enviará una nueva cotización.

2.5. - Se aceptan pedidos con la condición expresa de que nos reservamos el derecho de modificar modelos, imágenes, datos técnicos, precios, aumentos y descuentos, previo aviso al comprador. Los pedidos que se encuentren pendientes a la fecha de un posible cambio en las condiciones de venta se ejecutarán bajo las nuevas condiciones, entendiéndose que en estas circunstancias los clientes tienen derecho a cancelar dichos pedidos por escrito dentro de los 8 días siguientes a la fecha del aviso previo.

2.6.- Cualquier condición solicitada por el comprador que no se ajuste a nuestras condiciones generales de venta se considerará nula de pleno derecho, salvo que la aceptemos por escrito.

2.7.- No se podrán cancelar los pedidos cuando:

- Han pasado 3 días desde la fecha del pedido.  
- Cuando se trate de productos de fabricación especial, y ya se haya iniciado la misma.

- Si ha enviado la mercancía

2.8. - Nos reservamos el derecho de cancelar pedidos pendientes de entrega cuando el comprador no haya cumplido total o parcialmente contratos anteriores.

2.9. - Los precios y condiciones que se muestran en los catálogos son válidos durante el período de validez, salvo error de imprenta o tipográfico.

## 3. ENTREGA

3.1. - Los plazos de entrega que se indiquen verbalmente se entenderán siempre sin compromiso, por lo que deberán constar por escrito.

3.2.- Circunstancias que escapan al control de Udex, o de nuestros proveedores, a saber, accidentes de fabricación, huelgas, restricciones gubernamentales y, en definitiva, todas las causas de fuerza mayor, y que dificultan o imposibilitan el suministro, liberan a Udex de sus obligaciones contractuales durante la duración de las causas de fuerza mayor y el alcance de sus consecuencias, permitiendo la suspensión o cancelación de los pedidos de los clientes, sin responsabilidad alguna por las consecuencias directas o indirectas que pudieran derivarse.

En las situaciones pertinentes, se informará al comprador, a la mayor brevedad, sobre la fecha de inicio y finalización de los impedimentos.

3.3.- La transmisión del riesgo se produce cuando la mercancía es entregada al transportista o transitario o, como máximo, cuando la mercancía sale de la fábrica o almacén. Todas las mercancías viajan, sin excepción, por cuenta y riesgo del comprador, independientemente de la ruta utilizada. Salvo pacto en contrario, o indicación contraria en las condiciones particulares de cada producto, no asumimos los riesgos del transporte, que correrán íntegramente a cargo del comprador, incluso cuando los daños y deterioros durante el transporte se deban a caso fortuito o fuerza mayor. El hecho de que UDEX S.A contrate el transporte de las mercancías y que, en algunos casos, se otorgue una bonificación a su precio, no implica la cancelación de la cláusula anterior ni la aceptación por nuestra parte de los riesgos de la misma.

3.4. - La mercancía se envía embalada con el embalaje habitual, o según nuestro catálogo. Para paquetes a pedido del comprador, se cobrarán los precios correspondientes.

3.5. - No aceptamos la devolución de nuestros paquetes ya que no son retornables.

## 4. PAGO

4.1. - El pago del precio de nuestros bienes debe hacerse en efectivo en nuestras oficinas en Maia, a menos que se otorgue un crédito al comprador. En este caso, se realizará dentro del plazo o plazos expresamente señalados.

4.2.- Los pagos deberán efectuarse en las condiciones estipuladas por UDEX S.A, o a falta de indicación en los términos definidos por el Decreto-Ley N° cool. Si el comprador no liquida sus facturas dentro de los plazos establecidos, queda sujeto al pago de intereses de demora y la prima correspondiente, si la moneda se hubiere depreciado.

4.3. - Si, con anterioridad a la ejecución de todo o parte de un pedido, sobrevinieren o llegaren a conocerse hechos o circunstancias que hagan temer fundado que el comprador no cumplirá con su obligación de pagar el precio, la entrega de las mercancías podrá ser suspendido si el comprador no anticipa el pago y/o no lo garantiza en el plazo acordado.

4.4. - Los bienes facturados son de nuestra propiedad hasta el pago completo.

## 5. RECLAMACIONES Y DEVOLUCIONES

5.1.- Siempre que la mercancía sea entregada por nuestro transporte, las reclamaciones deberán realizarse en presencia de nuestro conductor y debidamente indicadas en las facturas, o documentos que acompañen a la mercancía durante el transporte. Si no es posible verificar el pedido al recibirlo, se puede realizar una reclamación por el producto en un plazo de 8 días desde la entrega del producto.

5.2. - No nos hacemos responsables del despacho de mercancías, ni de anomalías ocasionadas por los transportistas. Sólo se aceptará la devolución o cambio de material, hasta 8 días a partir de la fecha de entrega de la mercancía y deberá estar nueva, debidamente embalada en su caja original y sin faltantes. No aceptaremos más reclamaciones.

5.3. - No se aceptan devoluciones, salvo autori-

zación expresa por escrito de Udex. Los gastos y costes de transporte y embalaje corren a cargo del comprador. El material debe cumplir con el punto 5.2.

5.4. - En caso de devolución, se descontará del precio pagado por el cliente un porcentaje del 10% referente a los gastos de recepción y prueba.

## 6. GARANTIA

6.1. - Nuestros productos, siempre que sean utilizados en condiciones normales e instalados de acuerdo con la normativa vigente, están garantizados contra todo defecto de fabricación durante un periodo de 12 meses desde la fecha de salida de nuestro almacén. Para beneficiarse de esta garantía será necesario, en cada caso, la aceptación del defecto por parte de nuestro Departamento Técnico, debiendo enviarse los productos defectuosos a nuestro almacén. Nuestra garantía solo cubre el reemplazo de accesorios. No incluye reposición de gas, freón, filtros, mano de obra, soldaduras y desplazamientos. En ningún caso seremos responsables de los daños causados por su defecto, directa o indirectamente. Sólo cubre defectos de fabricación. Nunca averías provocadas por deficiencias de agua, electricidad o instalaciones independientes de aquéllas. Gastos de envío, embalaje, etc. Las reparaciones derivadas de la garantía corren a cargo del cliente.

6.2. - No incluido en la garantía:

- Lámparas, diodos, válvulas, transistores, vidrios, plásticos y otras partes rompibles, partes eléctricas, partes electrónicas, resistencias, motores, etc.

Situaciones en las que no se puede exigir la garantía:

1 - Siempre que el dispositivo no sea utilizado de acuerdo a la forma de uso.

2 - Si se arranca o modifica la placa de características.

3 - Si se modifica el dispositivo.

4- Cuando su mal funcionamiento se deba a abuso, causas externas (valores de voltaje incorrectos, descargas atmosféricas), exposición a la intemperie, etc.

5 - Si el dispositivo se nos entrega sin componentes.

6 - Incumplimiento del contrato (por parte del comprador).

7 - Cuando no se respete lo mencionado en el punto 5.2 de nuestras condiciones generales de venta.

## 7. PROPIEDAD DE LOS BIENES

7.1. - En caso de pago del precio a plazos o pacto de pago en fecha posterior a la entrega efectiva de los bienes, UDEX, S.A. se reserva el derecho de propiedad sobre esos mismos bienes hasta el pago total del precio respectivo. En caso de impago del precio en la(s) fecha(s) de vencimiento, y tras la resolución del contrato, UDEX, S.A. se reserva el derecho de proceder al cobro de los bienes objeto de comercio, sin necesidad de ulterior interpelación."

7.2. - Para todas las cuestiones derivadas del contrato, las partes reconocen como competentes a los Tribunales portugueses, con renuncia expresa a cualquier otro fuero.

8. Ningún empleado, agente, vendedor o representante de la empresa está autorizado a cambiar o cancelar cualquiera de las condiciones aquí indicadas, las cuales solo pueden ser modificadas por acuerdo de nuestra empresa, confirmado por escrito.





# GENERAL CONDITIONS OF SALE



In the absence of written agreement on our part, these general conditions of sale prevail over all contrary provisions. UDEX S.A does not sell directly to the public.

## 1. PRICES

1.1. - The prices contained in our proposals and price lists may be subject to possible adjustments whenever there are unforeseeable and uncontrollable changes in origin prices, freight and insurance, currency parity or any other variables that cause changes in prices.

1.2. - Our prices are always tax-free and are considered when leaving our warehouses or warehouses. All taxes in force at the time of invoicing (VAT) are added to the prices deducted from all discounts, which are borne by the buyer.

1.3. - The goods will be invoiced at the price in force on the date of the order.

1.4. - Our sales prices may be changed by simply notifying the buyer. The new prices will apply to all orders pending delivery on the date of the change. If the buyer does not accept the new price, he may cancel the order with written notice within 8 days of the date of notice. After this period, it will be understood that you fully accept the new conditions.

## 2. PRICE LISTS, CATALOGS, PROPOSALS AND ORDERS

2.1. - The information, which we provide verbally and as a guide, both with regard to prices, models, dimensions, images and characteristics, as well as specifications and budgets, is free of any commitment and does not oblige us to keep it and can be modified without early warning.

2.2. - The proposals are always and for all purposes, conditioned to our subsequent acceptance, in writing, of the corresponding order.

2.3. - Orders must be made in writing, otherwise they will not be considered valid.

2.4. - Orders will be invoiced at the price in force on the date of order, whenever the order is placed within the validity period of 8 days. If not, a new quote will be sent.

2.5. - Orders are accepted on the express condition that we reserve the right to modify models, images, technical data, prices, increases and discounts, upon prior notice to the buyer. Orders that are pending on the date of a possible change in the sales conditions will be executed under the new conditions, it being understood that in these circumstances customers have the right to cancel such orders in writing within 8 days following the date of notice. prior.

2.6. - Any condition requested by the buyer that does not conform to our general conditions of sale is considered null and void, unless we accept it in writing.

2.7. - Orders cannot be canceled when:

- 3 days have passed since the order date.
- In the case of products of special manufacture, and the same has already started.
- If you have shipped the goods

2.8. - We reserve the right to cancel orders pending delivery when the buyer has not fully or partially fulfilled previous contracts.

2.9. - The prices and conditions shown in the catalogs are valid during the period of validity, except for printing or typographical errors.

## 3. DELIVERY

3.1. - The delivery deadlines that are verbally indicated will always be understood without commitment, so they must be reduced to writing.

3.2. - Circumstances that fall outside the control of Udex, or our suppliers, namely manufacturing accidents, strikes, governmental constraints, and in short all causes of force majeure, and make it difficult or impossible to supply, release Udex of its contractual obligations during the duration of the

causes of force majeure and the extent of its consequences, allowing the suspension or cancellation of customer orders, without any liability for the direct or indirect consequences that may result.

In relevant situations, the buyer will be informed, as soon as possible, about the start and end date of the impediments.

3.3. - The transfer of risk takes place when the goods are delivered to the carrier or freight forwarder or, at most, when the goods leave the factory or warehouse. All goods travel, without exception, at the risk and expense of the buyer, regardless of the route used. Unless otherwise agreed, or otherwise indicated in the special conditions of each product, we do not assume the risks of transport, which will be entirely borne by the buyer, even when damage and deterioration during transport are due to fortuitous event or force majeure. The fact that UDEX S.A contracts the transport of the goods and that, in some cases, a bonus is granted to their price, does not imply the cancellation of the previous clause nor the acceptance by us of the risks thereof.

3.4. - The goods are shipped packed with the usual packaging, or in accordance with our catalogue. For packages at the buyer's request, the corresponding prices will be charged.

3.5. - We do not accept the return of our packages as they are non-returnable.

## 4. PAYMENT

4.1. - Payment of the price of our goods must be made in cash at our offices in Maia, unless credit is granted to the buyer. In this case, it will be carried out within the period or periods expressly stipulated.

4.2. - Payments must be made under the conditions stipulated by UDEX S.A, or in the absence of an indication under the terms defined by Decree-Law No. cool. If the buyer does not settle his invoices within the established due dates, he is subject to the payment of late payment interest and the corresponding premium, if the currency has depreciated.

4.3. - If, prior to the execution of all or part of an order, facts or circumstances arise or become known that give rise to a well-founded fear that the buyer will not fulfill his obligation to pay the price, delivery of the goods may be suspended if the buyer does not anticipate payment and/or guarantee it within the agreed period.

4.4. - The goods invoiced are our property until full payment.

## 5. COMPLAINTS AND RETURNS

5.1. - Whenever the goods are delivered by our transport, complaints must be made in the presence of our driver and duly indicated on the invoices, or documents accompanying the goods during transport. If it is not possible to verify the order upon receipt, a claim for the product can be made within 8 days from the delivery of the product.

5.2. - We are not responsible for the dispatch of goods, nor for anomalies caused by the carriers. The return or exchange of material will only be accepted, up to 8 days from the date of delivery of the goods and it must be new, properly packed in the original box and without missing parts. We will not accept any further claims.

5.3. - Returns are not accepted, unless expressly authorized by Udex in writing. Transport and packaging expenses and costs are borne by the buyer. The material must comply with point 5.2.

5.4. - In case of return, the price paid by the customer will be deducted by a percentage of 10% referring to reception and testing expenses.

## 6. WARRANTY

6.1. - Our products, as long as they are used under normal conditions and installed in accordance with the regulations in force, are guaranteed against all manufacturing defects for a period of 12 months from the date they leave our warehouse. In order

to benefit from this guarantee, it will be necessary, in each case, to accept the defect by our Technical Department, and the defective products must be sent to our warehouse. Our warranty only covers replacement of accessories. Does not include replacement of gas, freon, filters, labour, welding and displacements. Under no circumstances can we be held liable for damages caused by your defect, directly or indirectly. It only covers manufacturing defects. Never malfunctions caused by deficiencies in water, electricity or installations independent of the former. Costs, shipping, packaging, etc. arising from warranty repairs are at the customer's expense.

6.2. - Not included in the warranty:

- Lamps, diodes, valves, transistors, glass, plastics and other breakable parts, electrical parts, electronic parts, resistors, motors, etc.

Situations in which the guarantee cannot be demanded:

1 - Whenever the device is not used according to the way of use.

2 - If the nameplate is torn off or modified.

3 - If the device is modified.

4 - When its malfunction is due to abuse, external causes (incorrect voltage values, atmospheric discharges), exposure to the weather, etc.

5 - If the device is delivered to us without components.

6 - Failure to comply with the contract (by the buyer).

7 - When the above mentioned in point 5.2 of our general conditions of sale is not respected.

## 7. OWNERSHIP OF THE GOODS

7.1. - In the event of payment of the price in instalments or agreement for payment on a date subsequent to the actual delivery of the goods, UDEX, S.A. reserves for itself the right of ownership of those same goods until the respective price is fully paid. In the event of non-payment of the price on the due date(s), and after termination of the contract, UDEX, S.A. reserves the right to proceed with the collection of the traded goods, without the need for further interpellation."

7.2. - For all matters arising from the contract, the parties recognize the Portuguese Courts as competent, with express waiver of any other jurisdiction.

8. No employee, agent, vendor or representative of the company is authorized to change or cancel any of the conditions indicated herein which can only be modified by agreement of our company, confirmed in writing.



embalagens especiais e/ou madeira sob consulta  
emballage spécial et/ou de bois sur demande  
embalajes especiales y/o de madera bajo consulta  
special packaging and/or wood on request

## UDEX Portugal - Head Office

Rua do Outeiro, 884  
Zona Industrial da Maia I, Sector I  
Apartado 6008 - Outeiro  
4476-908 Maia - Portugal  
+351 22 943 94 20  
udex@udex.pt

## UDEX Lisboa

Rua de Timor  
Lote 122 - Loja Direita  
2620-064 Olival de Bastos, Portugal  
+351 21 938 63 77 | 21 938 64 27  
lisboa@udex.pt

## UDEX España

Av. País Valenciano, nº 30 B  
46970 Alaquas (Valencia)  
+34 96 111 01 20 | +34 650 882 799  
udex@udex.es | www.udex.es

## UDEX PORTUGAL - International

Europa • Angola • Cabo-Verde • Guiné-Bissau  
Moçambique • São Tomé e Príncipe • Senegal



SOLUTIONS FOR LIFE

